



## **S** series **SD9366-EH-v2** Speed Dome Network Camera

1080p 60fps • 30x Zoom • WDR Pro • 250M IR •  
Smart IR II • IP66 • IK10 • NEMA 4X • -50°C ~ 55°C • Wiper

The SD9366-EH-v2 is the latest professional IR speed dome camera with wiper from VIVOTEK, specifically designed to enhance low light surveillance in large coverage areas. Equipped with 250M IR illuminators and a 30x optical zoom lens, the SD9366-EH-v2 provides a superb low light image in the most challenging situations. The camera also adopts VIVOTEK's Smart IR II technology, Vari-Angle IR. VIVOTEK's Vari-Angle IR provides smooth vari-angle adjustment of the IR illuminators, allowing broad coverage FOV and highly uniform IR intensity while avoiding hot-spots traditionally associated with IR illumination.

The SD9366-EH-v2 is the PTZ surveillance camera with IR Illumination to utilize H.265 compression technology. When combined with VIVOTEK's Smart Stream II technology users can obtain bandwidth savings of up to 80%\* compared to traditional

H.264. By combining 1080p full HD resolution with H.265, IR illuminators, Vari-Angle IR, WDR, and 30x optical zoom, the SD9366-EH-v2 is able to capture fine details at top-notch quality, 24 hours a day, 7 days a week.

VIVOTEK further strengthened the camera performance with an IP66- and NEMA 4X-rated housing to protect the camera against rain, dust, and corrosion. The SD9366-EH-v2 has a wide operating temperature range from -50°C to 55°C, ensuring continuous operation under the most extreme weather conditions and hazardous environments. This makes the SD9366-EH-v2 ideally suited to monitor wide open spaces such as ports, highways, cities, and parking lots where high-level precision is required.

\* Depending on scene.

### Key Features

- H.265 Compression technology
- 1080P Full HD CMOS Sensor
- 60 fps @ 1080p Full HD
- 30x Zoom Lens
- 250M IR with Smart IR II (Vari-Angle IR)
- 360° Continuous Pan and 220° Tilt
- Removable IR-cut Filter for Day & Night Function
- WDR Pro for Unparalleled Visibility in High Contrast Environments
- Weather-proof IP66-rated, Vandal-proof IK10 and NEMA 4X-rated Housing
- -50°C ~ 55°C Wide Temperature Range for Extreme Weather Conditions
- EIS (Electronic Image Stabilization) to Control Image Stability
- Easy Cleaning with Built-in Wiper



Without Smart IR II



With Smart IR II

## Technical Specifications

Model	SD9366-EH-v2		
<b>System Information</b>			
CPU	Multimedia SoC (System-on-Chip)		
Flash	128 MB		
RAM	512 MB		
<b>Camera Features</b>			
Image Sensor	1/2.8" Progressive CMOS		
Max. Resolution	1920x1080 (2MP)		
Lens Type	30x Optical Zoom, Auto Focus		
Focal Length	f = 4.3 ~ 129 mm (30x zoom)		
Aperture	F1.6 ~ F4.7		
Iris Type	DC-iris		
Field of View	64° ~ 2.3° (Horizontal) 36° ~ 1.3° (Vertical) 73° ~ 2.6° (Diagonal)		
Shutter Time	1 sec. to 10,000 sec.		
WDR Technology	WDR Pro		
Day/Night	Yes		
Removable IR-cut Filter	Yes		
Minimum Illumination	0.195 Lux @ F1.6 (Color) 0.01 Lux @ F1.6 (B/W) 0 Lux with IR illumination on		
Pan Speed	0.1° ~ 300° / sec.		
Pan Range	360° endless		
Tilt Speed	0.1° ~ 300° / sec.		
Tilt Range	220° (-110° ~ +110°)		
Preset Locations	256 preset locations 128 presets per tour		
Pan/Tilt/Zoom Functionalities	48x digital zoom (4x on IE plug-in, 12x built-in), Auto pan mode, Auto patrol mode		
Illuminators	Built-in 850nm IR Illuminators up to 250 meters with Smart IR II, IR LED*2		
Storage	Seamless Recording to MicroSD/SDHC/SDXC card and recording to network-attached storage (NAS)		
<b>Video</b>			
Compression	H265, H264, MJPEG		
Maximum Frame Rate	H.265 & H.264: 60 fps @ 1920x1080 MJPEG: 30 fps @ 1920x1080		
Maximum Streams	4 video streams (Up to 9 configurable profiles)		
S/N Ratio	66 dB		
Dynamic Range	130 dB		
Video Streaming	Adjustable resolution, quality and constant bit rate control, Smart Stream II		
		Image Settings	Time stamp, text overlay, flip and mirror, configurable brightness/contrast/saturation/sharpness, white balance, exposure control, gain, backlight compensation, privacy masks (Up to 24), scheduled profile settings, defog, 3DNR, EIS, HLC
		<b>Audio</b>	
		Audio Capability	Two-way Audio (full duplex)
		Compression	G.711, G.726
		Interface	External microphone input External line output
		<b>Network</b>	
		Users	Live viewing for up to 10 clients
		Security	Access list, digest authentication, HTTPS, IEEE 802.1x, Password protection, signed firmware, Trend Micro IoT Security (brute force attack event, cyberattack event, quarantine event), user access log, user account management
		Protocols	802.1X, ARP, Bonjour, CIFS/SMB, DDNS, DHCP, DNS, FTP, HTTP, HTTPS, ICMP, IGMPv3, IPv4, IPv6, NTCIP, NTP, PPPoE, QoS (CoS/DSCP), RTSP/RTP/RTCP, SMTP, SNMP, SSL, TCP/IP, TLS 1.2, UDP, UPnP
		Interface	10 Base-T/100 Base-TX Ethernet (RJ-45) *It is highly recommended to use standard CAT5e & CAT6 cables which are compliant with the 3P/ETL standard.
		ONVIF	Profile G, S, T supported, specification available at <a href="http://www.onvif.org">www.onvif.org</a>
		<b>Solution Integration</b>	
		Video Motion Detection	Five-window video motion detection
		Auto-Tracking	Auto-tracking on moving object
		VADP Package	Trend Micro (3-year free trial), Stratocast
		<b>Alarm and Event</b>	
		Event Trigger	Audio detection, camera tampering detection, cybersecurity events (brute force attack event, cyberattack event, quarantine event), digital input, manual trigger, motion detection, periodical trigger, recording notification, SD card life expectancy, system boot
		Event Action	Event notification via audio clip, digital output, email, HTTP, FTP, NAS server, SD card, push notification File upload via email, HTTP, FTP, NAS server, SD card
		<b>General</b>	
		Connectors	RJ-45 cable connector for 10/100Mbps Network/PoE connection Audio line input Audio line output AC/DC 24V power input Digital input *4 Digital output *2 RS-485 (Pelco D, Baud rate 2400)* 1
		LED Indicator	System power and status indicator
		Power Input	AC 24V, DC 24V, PoH/PoE (95W) (Simultaneous Power Redundancy Supported)

## Technical Specifications

Power Consumption	AC/DC 24V: Max. 63 W (Heater on) Max. 45 W (Heater off) PoH/PoE (95W): Max. 70 W (Heater on) Max. 51 W (Heater off)
Dimensions	237 x 364 mm
Weight	7.1 kg (with bracket) 5.7 kg (without bracket)
Certifications	EMC: CE, LVD, FCC Class A, VCCI; Safety: UL; Environment: IK10, IP68, NEMA 4X
Operating Temperature	Starting Temperature: -40°C ~ 55°C (-40°F ~ 131°F) Working Temperature: -40°C ~ 55°C (-40°F ~ 131°F) (DC 24V) -50°C ~ 55°C (-58°F ~ 131°F) (AC 24V/PoH (95W)) *Wiper is functional at 10°C to 55°C (50°F to 131°F)
Humidity	98% RH (non-condensing)
Warranty	36 months
<b>System Requirements</b>	
Operating System	Microsoft Windows 10/8/7 Mac 10.12 (Chrome only)

Web Browser	Chrome 58.0 or above Internet Explorer 10/11
Other Players	VLC: 1.1.11 or above

### Included Accessories

Packing Contents	Wall mount bracket, I/O cable, screws, waterproof connectors, terminal blocks, quick installation guide, alignment sticker, ground wire, T25 star driver, desiccant bags
------------------	--



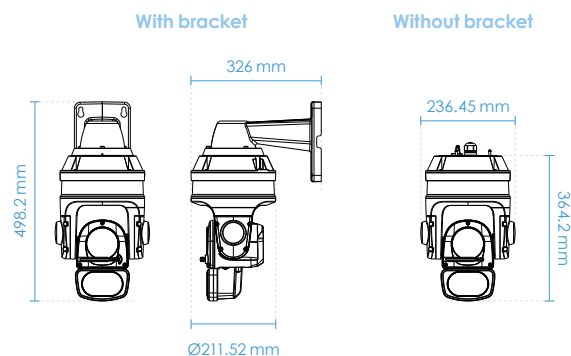

### Dimensions





## Compatible Accessories

Mounting Kits			Others		
 AM-220 Wall Mount Bracket (standard package)	 AM-529 Mounting Adapter	 AE-301 Water Tank, 24VAC/DC, 0°C ~ 60°C	 AJ-001 USB Joystick	 AJ-002 USB Joystick	 AO-007 I/O Combo Cable

### Cabinet

 AT-CAS-001 Cabinet for Speed Dome	 AT-CAB-002 Cabinet for HLG Power Supply	 AT-SUN-002 Sunshield	 AT-SWH-000 Power Safety Kit	→ 
--	--	--	---	---

### Power Adapter

24VAC	24VDC
 AA-352 Outdoor Power Box, 24VAC/144W, IP67, IK10	 HLG-120H-24 Industrial 24VDC/120W Power Supply, IP67

## Compatible Accessories

### 95W PoH/PoE



AP-GIC-011A-095  
1xGE 95W PoH/PoE Injector with Surge Protection 12KV



AP-GIC-015B-095  
Outdoor 1xGE 95W PoH/PoE Injector with Surge Protection 12KV, IP67, IK10