

# WAIST HEIGHT TURNSTILE

## INSTALLATION AND MAINTENANCE HANDBOOK

### WARRANTY CERTIFICATE

# INDEX

<b>1.</b>	<b>GENERAL INFORMATION</b> .....	<b>4</b>
1.1.	Preface	
1.2.	General Information on Turnstiles	
1.3.	Waist Height Turnstile Models	
<b>2.</b>	<b>SAFETY AND OPERATION</b> .....	<b>5</b>
2.1.	Safety Warnings and Symbols	
2.2.	Power Supply Fuse	
2.3.	Safety Related Instructions	
2.4.	Operating Conditions	
<b>3.</b>	<b>HANDLING AND INSTALLATION</b> .....	<b>6</b>
3.1.	Handling	
3.2.	Installation	
3.3.	Installation Illustrations For Different Surface Mounting Bracket Versions	
3.4.	Arm Mounting (Fixed Arm Models)	
3.5.	Arm Mounting (Drop Arm Models)	
3.6.	Wing Mounting (Wide Access/ DDA models)	
<b>4.</b>	<b>TURNSTILE SYSTEM SPECIFICATIONS</b> .....	<b>9</b>
4.1.	Waist Height Turnstile System Specifications Table	
4.2.	System Specifications – Tripod Models	
4.3.	System Specifications- Wide Access / DDA Models - Turnstiles For Reduced Mobility	
4.4.	Indicators	
4.5.	Equipment and Accessories	
<b>5.</b>	<b>SETUP AND OPERATION</b> .....	<b>12</b>
5.1.	Power and Grounding Connections	
5.2.	Control Board Inputs and Outputs	
5.3.	Control Board External Component Connections	
5.4.	Control Board Settings	
5.4.1.	Blocking Passage Direction	
5.4.2.	Dip Switch Settings	
5.4.3.	Magnetic Encoder Arm Stop Settings	
A)	Tripod	
B)	VIP	
5.5.	Hydraulic Damper Settings (Manual Models)	
<b>6.</b>	<b>POST INSTALLATION CHECK LIST</b> .....	<b>24</b>
<b>7.</b>	<b>SERVICE AND MAINTENANCE</b> .....	<b>24</b>
7.1.	Maintenance Instructions	
7.1.1.	Recommended User Maintenance	
7.1.2.	Periodic Maintenance by Technical Service Personnel	
7.2.	Trouble Shooting and Repair Guide	
<b>8.</b>	<b>LIST OF REPLACEMENT SPARE PARTS</b> .....	<b>27</b>
8.1.	Waist Height Model Turnstiles	
8.2.	Wide Access / DDA Models - Turnstiles For Reduced Mobility	
<b>9.</b>	<b>CE DECLARATION OF CONFORMITY AND WARRANTY</b> .....	<b>29</b>
9.1.	Warranty Certificate	
9.2.	Warranty Terms and Conditions	
9.3.	Cases Excluded From The Coverage of Warranty	
9.4.	Declaration of CE Compliance	

## 1. GENERAL INFORMATION

### MANUFACTURER:

#### ÖZAK Geçiş Teknolojileri Sanayi Ticaret A.Ş.



**Address** : Çuhane Caddesi No:130 41080 Köseköy-KARTEPE / KOCAELİ  
**Tel & Fax** : +90 262 373 48 48 Pbx.  
**E-mail** : ozak@ozak-t.com  
**Web** : www.ozak-t.com

### 1.1 Preface

Thank you for choosing the products of **Özak** and your confidence in our company.

Your system has been designed and manufactured to meet the most demanding requirements of professional access control applications. All components of your system have been selected with utmost care and thoroughly tested to ensure optimal performance and reliability.

To safely operate your product with maximum performance and service life please follow the instructions written in this manual carefully, and keep it for future reference. In case of any operational questions or unexpected issues please refer to the explanations contained in this document.

**To obtain technical support or replacement parts please contact Özak Technical Service Department by E-mail or telephone.**

#### **Özak Technical Service Department:**

**Telephone** : +90 262 373 48 48 **Ext:** 1301-1304

**E-mail** : support@ozak-t.com

**Özak reserves the right to change the contents of this document without prior notice!**

### 1.2 General Information on Turnstiles

Turnstiles are devices that enable passage control and prevent uncontrolled or unauthorized passages in stadiums, sports halls, leisure facilities, business centers, public transportation areas, museums, banks, industrial facilities and all premises where collective entrance and exit control are required.

As passage controlling units, turnstiles have the ability to work with any type of access control system such as barcode, magnetic card, proximity card readers, tokens, buttons etc. With the exception of disabled wide-access panel models, only "one person at a time" philosophy is adopted for all turnstile products. The turnstiles are designed for bi-directional operation while allowing simple mode selection by a dip switch for restricted or one way free passage.

The turnstiles are made of stainless steel or electrostatic powder coated DKP sheet metal. In double-sided models, two separate passage systems are integrated into a single structure. As the turnstiles are anchored on a wide surface area, the overall structure is firmly balanced and robust. Due to their structural characteristics, turnstiles are not affected by rain, water, or similar outdoor conditions. All mechanical components are galvanized for protection against corrosion.

Our turnstiles are certified with "TSEK product quality" (A Turkish certification of quality) and CE Declaration of Conformity.

### 1.3 Waist Height Turnstile Models

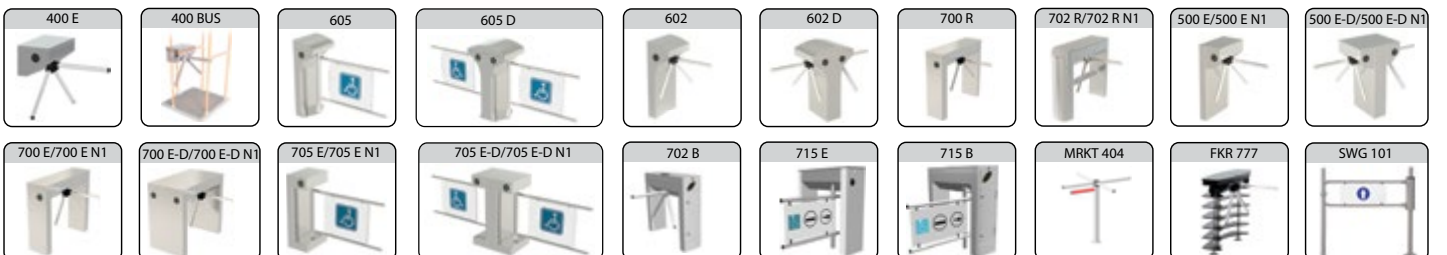

## 2. SAFETY AND OPERATION

### 2.1 Safety Warnings and Symbols

For Safety and proper operation of the turnstile, all installation and repair work must be performed by qualified technical personnel only!

#### HIGH VOLTAGE WARNING LABEL

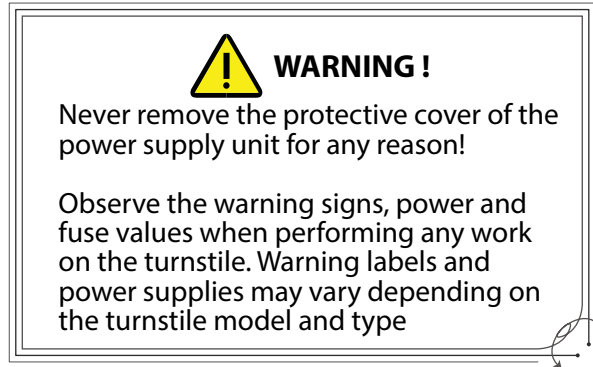
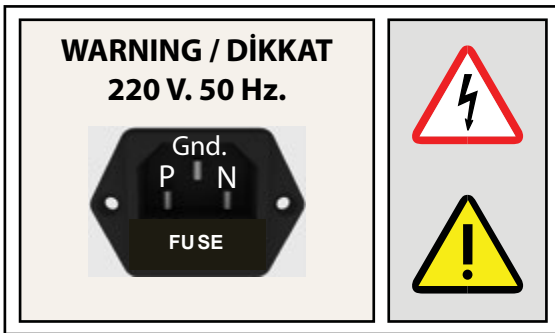

#### GROUNDING SYMBOL

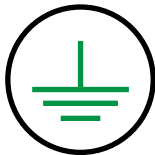

#### POWER CONNECTOR FRONT VIEW

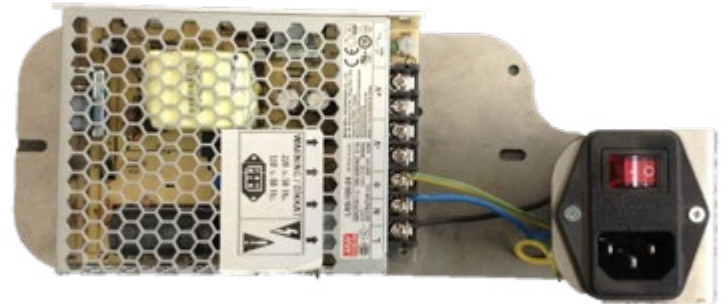
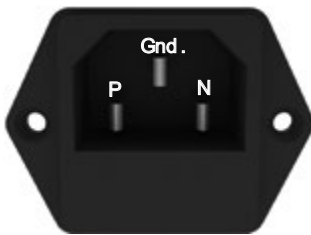

24 V DC POWER SUPPLY

### 2.2 Power Supply Fuse

 Use only the same type and rating of fuse as selected by the manufacturer!

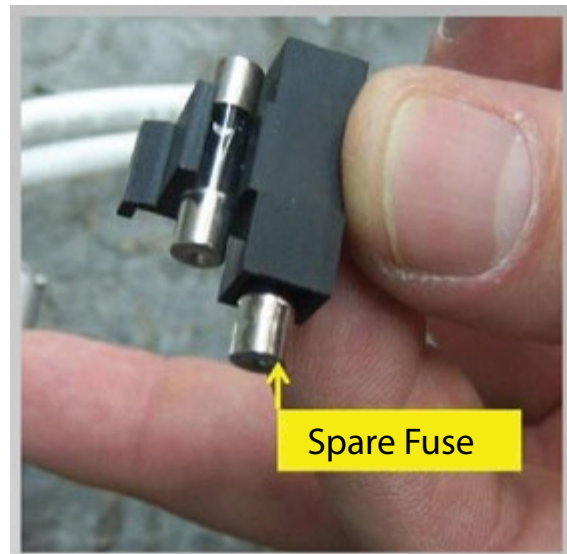
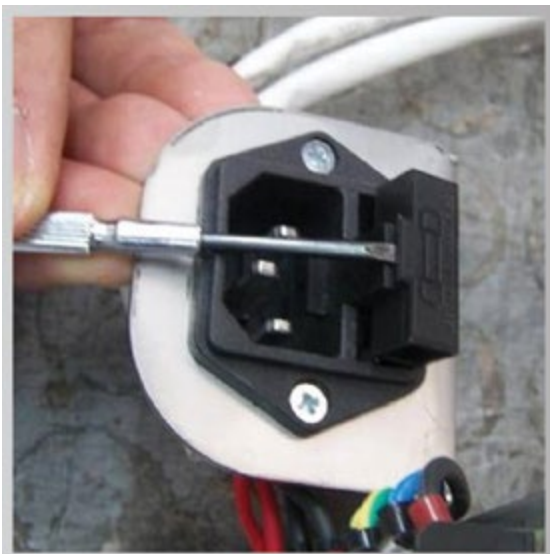

The fuse and a spare are located inside AC power socket

## 2.3 Safety Related Instructions

---

1. Users must not dismantle the turnstiles. Maintenance can only be performed by competent and authorized personnel. Maintenance work attempted by non-qualified individuals may create danger to users and the turnstile.
2. Turnstile must not be installed at places where there is a risk of explosion caused by electrical arcs or a probable gas leakage.
3. Turnstile must be kept away from flammable environments.
4. Turnstile should not be installed at places where there is vibration.
5. Turnstile must not be kept in excessively moist environments.
6. Turnstile must not be exposed to heat.
7. Turnstiles must not be subjected to abusive treatment such as impact or excessive shaking.
8. Turnstile must be kept away from high level magnetic fields.
9. Operating voltage/ power range must be observed in all installations. .
10. The power must be stable, properly grounded, insulated.
11. Turnstiles can only be operated under the environmental conditions and temperatures specified by the manufacturer.
12. Children must not be allowed to play with the turnstiles.
13. All connections must be confirmed to be correct before supplying power to the turnstile.
14. Only materials and equipment recommended by the manufacturer must be used for the turnstile when making connections into the input and output terminals.
15. All parts and accessories used in the turnstiles must be approved by the manufacturer.
16. In case of any electrical arcing or faults caused by such condition, power must be disconnected and authorized servicer or manufacturer must be contacted as soon as possible.
17. The power must be cut off before cleaning or maintenance.
18. Only clean, soft and moist fabrics (no abrasive materials) should be used for cleaning the turnstile surfaces.
19. Damaged turnstiles must not be operated, and the authorized dealer or the manufacturer's technical support center should be contacted as soon as possible for repair.

## 2.4 Operating Conditions

---

1. More than one person must not attempt to pass at the same time.
2. Turnstile must not be forced, kicked, abused or tampered with to gain passage without authorization.
3. Turnstiles must not be washed for cleaning purposes (applying water with a hose or pouring water from a bucket. etc). Wiping off with non abrasive materials such as a damp cloth is sufficient in most cases.
4. Chemicals and abrasives must not be used in any case for cleaning. The manufacturer is not responsible for damages resulting from use of such materials.

## 3. HANDLING AND INSTALLATION

---

### 3.1 Handling

---

1. Please pay special attention to carry the turnstiles as originally packed by the manufacturer.
2. Follow the handling and carrying instructions written on the package.
3. Do not place a heavy load on the turnstile package.
4. Do not place the packed turnstile on a wet ground.
5. Do not leave the packed turnstile under rain.
6. During handling, use an appropriate lift/crane with sufficient lifting capacity.
7. Before starting installation ensure that there is no shipping damage or missing parts and hardware inside the package.

### 3.2 Installation

---

1. The installation place should be selected according to user's requirements. This selection should not prevent the smooth operation of the turnstiles.
2. Ensure that the installation surface is flat, even and of proper strength. Flatten any uneven/ rough areas if necessary.
3. Mark the holes and drill with a size 10 drill bit. Clean the debris inside the holes by pressurized air.
4. Fill the holes with chemical plaster and fix anchoring bolts (size 8) in place by rotating. Chemical plaster dries in about 25 minutes.
5. Place turnstile on anchoring bolts and tighten the nuts to secure in place.
6. Connect power and control cables.

**\*\* A model specific mounting plan is supplied with the turnstile.**

### 3.2.1 Installation Illustrations For Different Surface Mounting Bracket Versions

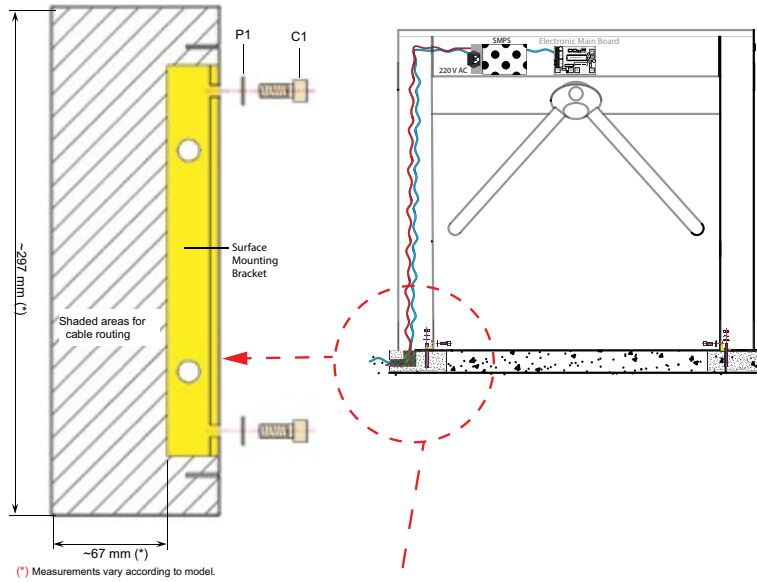

(\*) Measurements vary according to model.

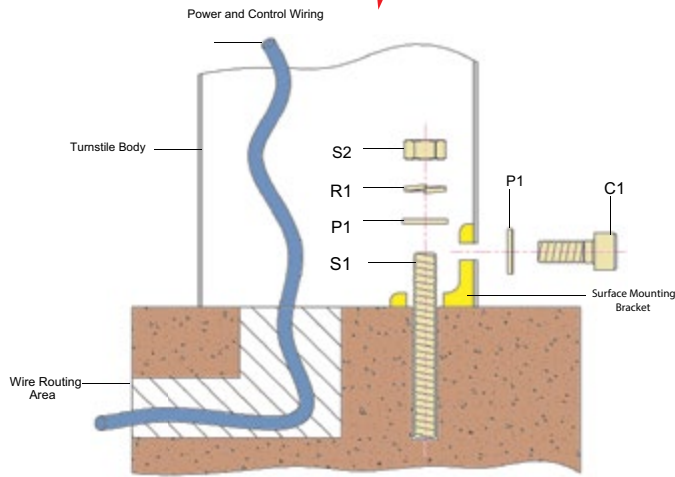

**Version 1**

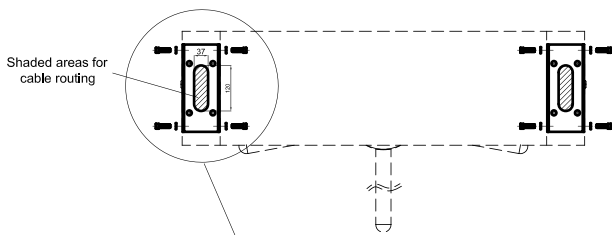

Shaded areas for cable routing  
Surface Mounting Bracket

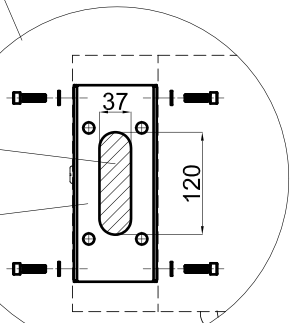

**Version 2**

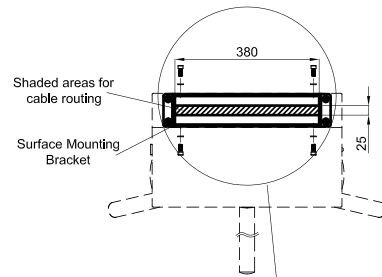

Shaded areas for cable routing  
Surface Mounting Bracket

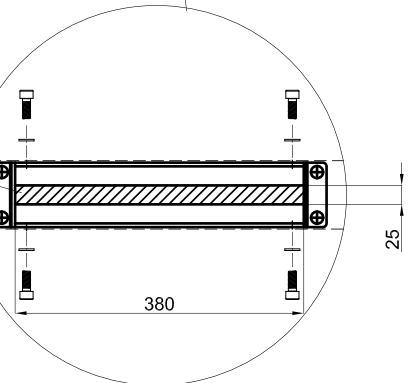

**Version 3**

### 3.3 Arm Mounting (Fixed Arm Models)



Arm must be mounted correctly to prevent loosening and dropping during use!

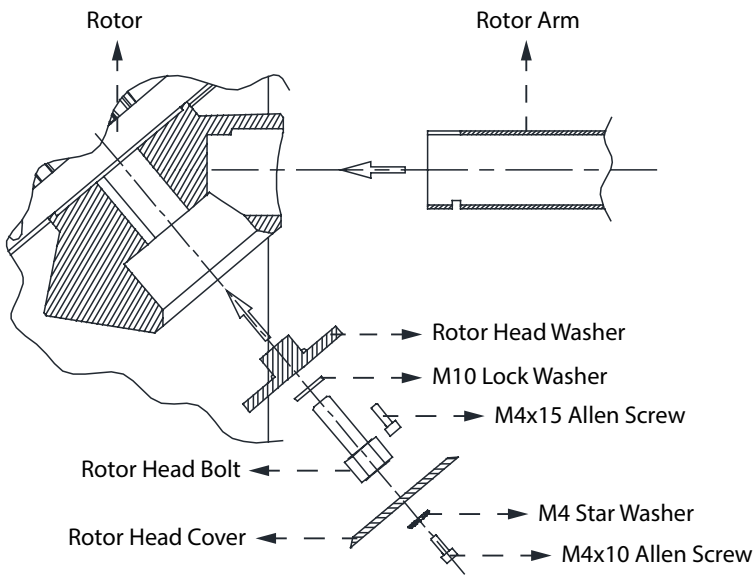

**CORRECT INSTALLATION**

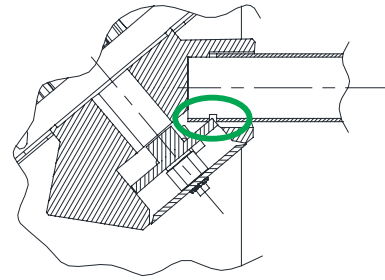

**WRONG INSTALLATION**

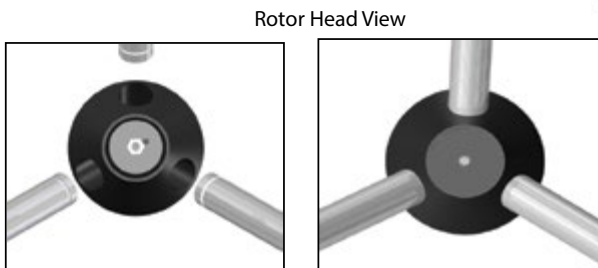
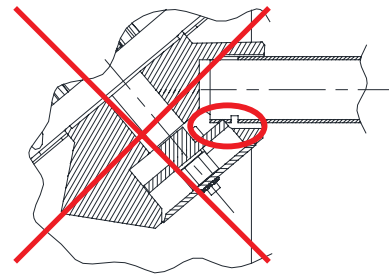

A1	R1	V1	V2	C1	T1	V3
Rotor Head Fixing Washer	M10 Lock Washer	M10x30 Bolt	M4x15 Screw	LID	M4 Star Washer	M4x10 Screw
1	1	1	1	1	1	1

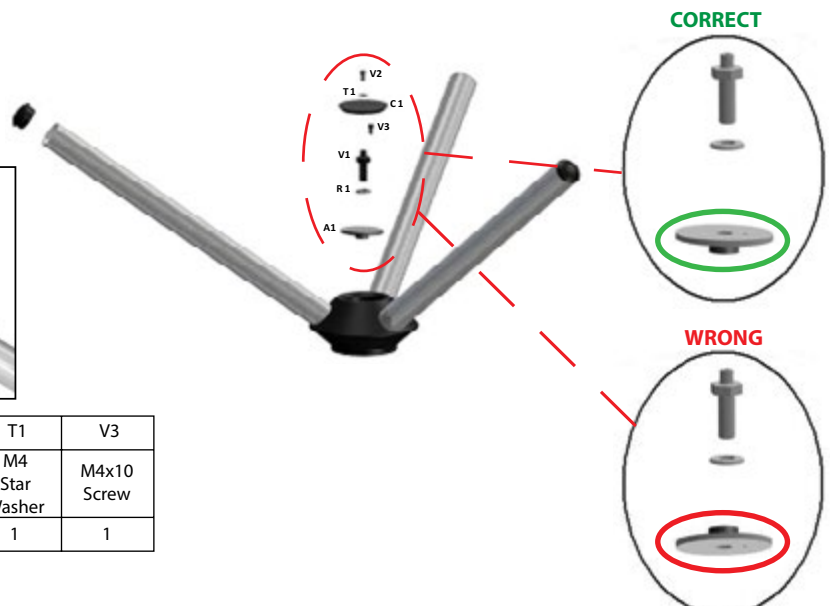

### 3.4 Arm Mounting (Drop Arm Models)



1. Seat the arm on the rotor



2. Place Allen screws (2 pcs)



3. Tighten screws with 5 mm. keys

### 3.5. Wing Mounting (Wide Access/ DDA models)



1. Insert panel in place.



2. Tighten top fixing screw



3. Tighten bottom fixing screw

## 4. TURNSTILE SYSTEM SPECIFICATIONS

### 4.1 Waist Height Turnstile System Specifications Table

WAIST HEIGHT MODELS	MECHANISM		OPERATIONAL FEATURES			MATERIALS			
	MANUEL	MOTORIZED	MOVEMENT	LOCK CONTROL	STOPPING	MAIN ROTOR	ARM / WING	LOCKS	
400 E	X		Manuel Push (opt. Motor)	Solenoid	Hydraulic Damper	Polyamide + Steel	Chrome/*	3 Arms	
400 BUS	X								
602 / 602 D	X								
500 E / 500 E-D	X								
500 E N1 / 500 E-D N1	X								
702 B	X								
700 E / 700 E-D	X								
700 E N1 / 700 E-D N1	X								
700 R	X								
FKR 777	X		Motor	---	Motor	Polyamide	Acrylic / Other**	1 Wing	
605 / 605 D		X							
705 E / 705 E-D		X							
705 E N1 / 705 E-D N1		X							
715 E		X							
715 B		X							
SWG 101	X		Push	---	Spring	Steel	Chrome/*	Steel	
MRKT 404	X			Locked Ball Bearing	---				
702 R / 702 R N1		X	Motor	Solenoid	Motor	Polyamide		4 Arms	---
								3 Arms	Polyamide

\* Al.: Aluminium

\*\* Optional Materials : Acrylic, Painted Steel, Stainless Steel, Wood.



## 4.2 System Specifications – Tripod Models



1. System is designed for bi-directional operation. In standard models, when power is cut off, arms freewheel to allow free passage in both directions; optionally the arms can be set up to lock (fail-lock) when power is cut off.
2. Mechanical parts of the turnstiles are made of stainless steel and galvanized metal. Main lock, balancing systems and lock offsets of the rotating equipment are made of injection molded polyamide.
3. Once passage is permitted and arms rotate 30 degrees, arms will not return, and until the completion of the movement another passage is not allowed by the system.
4. After each complete passage the manual system returns to standby position smoothly and quietly by means of a hydraulic shock absorber. Motor driven versions complete rotation by a gentle push following authorization.
5. Signalization is provided with direction indicators placed on both sides of the upper body of the turnstile (While green arrow indicates active passage direction, red bar shows the blocked passage direction). In addition to the visual signalization with green/ red indicators, an audio buzzer signal is provided during passage.
6. Solenoids used within the system are driven by PWM for reliability, optimal energy efficiency and less heat. They do not warm up to more than 10 degrees of the ambient temperature.
7. Electronic board controlling the system is designed as “coated inside the hole.” Therefore, it is not affected by vibration.
8. The micro-processor based electronic control system used in the turnstiles can be programmed for various functions and operating modes by a simple dip switch selection.
9. All inputs and outputs are isolated by opto-coupler and relay components for increased reliability.
10. Turnstiles can be activated or blocked with the signals received from data collection systems (full closed). For dropping arm applications, an arm control unit, battery charger and a rechargeable battery are included as standard feature.
11. The power supply is supported by “switching-mode” technology for better voltage regulation and energy efficiency.
12. Turnstile only allows passages of authorized people. If a person does not pass within a pre-set time limit following authorization contact (selectable for 6, 12, 18 or infinite seconds), the system automatically locks and returns to standby.
13. After passage, the system provides dry contact relay output for each direction. An optional counter can be used.
14. Electronic control unit of the turnstile is protected against water for outdoor installations.
15. Turnstiles can work in synchronization with door-type metal detectors; for security purposes, even passage of a person with authorization can be blocked automatically upon receiving contact from a metal detector. The system can be returned to normal operation by the operator.
16. In cases of emergency the turnstile can be switched into “**emergency mode**” with a normally closed manual button or relay from fire alarm system. In emergency mode arms rotate freely in both directions allowing free passage.
17. Turnstile passage directions can be arranged in different combinations. (For example: one direction blocked, other direction controlled or free; both directions controlled, or one direction free and other controlled)
18. Turnstiles allow passage of only one person at a time for each authorization contact into the control board.
19. Card readers or similar access control systems can be integrated into the turnstiles separately or jointly for controlling both sides depending on the needs and specific requirements.
20. Once a passage is completed, an entrance or exit direction data (dry contact) is provided to the data collection terminal.

### 4.3 System Specifications- Wide Access/ DDA Models-Turnstiles For Reduced Mobility

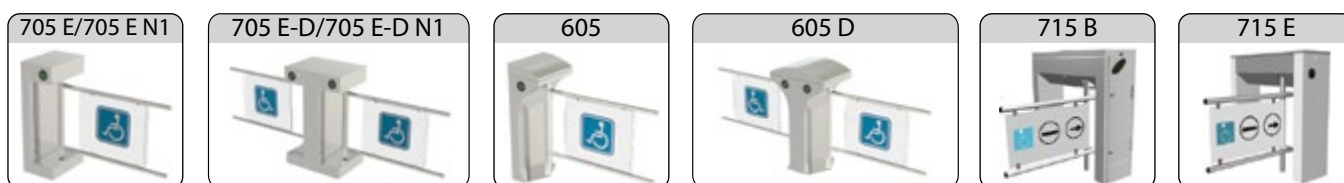

1. Microprocessor controlled, bi-directional wide access system (Only 715-B ve 715-E models are uni-directional)
2. PWM DC motor driven system for quiet and efficient operation.
3. Panel unlocks and opens 90° automatically in either direction when a contact is received on Input A or Input B terminals. The panel stops and tries to continue its movement once more if it meets an obstacle during its movement. If the obstacle is still present an alarm is activated and the panel is released. The system self-resets within 8 seconds.
4. Timing can be re-set manually or by an optional photocell unit for immediate closing of the panel following a passage.
5. **Emergency Mode:** The panel opens automatically in either direction as determined by the dip switch setting when emergency mode is activated by opening a normally closed switch or fire alarm relay contact. Unit returns to normal operation when emg-gnd contact is re-established.

### 4.4 Indicators

The system features status indicators on both sides for user guidance.



**RED CROSS:** System is closed



**GREEN ARROW:** Passage allowed.

Buzzer is heard when a passage is authorized.

In addition to the side indicators, an optional top passage indicator is available which provides further guidance by a blinking green arrow during passage. In alarm mode the indicators alternately blink in red and green and buzzer is heard.

### 4.5 Equipment and Accessories

MODEL	Standard Features		Optional Features / Accessories														
	Indicators		Photocell	Coin System	Card Reader System	Remote Control	Dropping Arm	Heater Positive	Intercom Unit	Alarm Unit					Counter	Passage Limiter	
	Pass	Guidance								Pressure	Earth Quake	Under Arm Passage	Climb Over Pasagge	Weight			
Waist Height (Tripods)	400 E	O	✓	O	O	O	O	-	O	O	-	O	O	O	-	O	O
	400 BUS	O	✓	O	O	O	O	-	O	O	-	O	O	O	-	O	O
	602 / 602 D	O	✓	O	O	O	O	O	O	O	O	O	O	O	O	O	O
	500 E / 500 E-D	O	✓	O	O	O	O	O	O	O	O	O	O	O	O	O	O
	500 E N1 / 500 E-D N1	O	✓	O	O	O	O	O	O	O	O	O	O	O	O	O	O
	702 B	✓	✓	O	O	O	O	O	O	O	O	O	O	O	O	O	O
	702 R / 702 R N1	✓	✓	O	O	O	O	O	O	O	O	O	O	O	O	O	O
	700 E / 700 E-D	O	✓	O	O	O	O	O	O	O	O	O	O	O	O	O	O
	700 E N1 / 700 E-D N1	O	✓	O	O	O	O	O	O	O	O	O	O	O	O	O	O
	700 R	O	✓	O	O	O	O	O	O	O	O	O	O	O	O	O	O
FKR 777	✓	✓	O	O	O	O	O	O	O	O	O	O	O	O	O	O	
Turnstiles for Reduced Mobility	605 / 605 D	O	✓	O	O	O	O	-	O	O	O	O	-	O	O	O	O
	705 E / 705 E-D	O	✓	O	O	O	O	-	O	O	O	O	-	O	O	O	O
	705 E N1 / 705 E-D N1	O	✓	O	O	O	O	-	O	O	O	O	-	O	O	O	O
	715 E	O	✓	O	O	O	O	-	O	O	O	O	-	O	O	O	O
	715 B	O	✓	O	O	O	O	-	O	O	O	O	-	O	O	O	O
Free Passage	SWG 101	-	-	-	-	-	-	-	-	-	-	-	-	-	-	-	-
	MRKT 404	-	-	-	-	-	-	-	-	-	-	-	-	-	-	-	-

✓ - Standard  
O - Optional

## 5. SET UP AND OPERATION

### 5.1 Power and Grounding Connections

#### TURNSTILE POWER WARNING LABEL

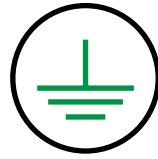
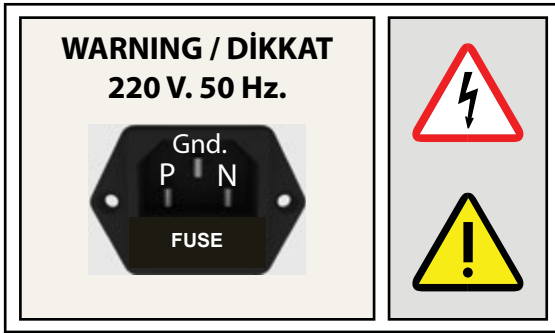

Grounding (Gnd.)



Proper grounding must be ensured to prevent shock hazard!



Power and grounding connections must be made by a qualified electrician in accordance with the relevant local regulations using appropriate materials!

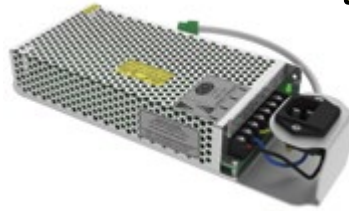

Never remove the protective cover of the power supply unit for any reason! In case of a power supply failure, the power supply unit must be replaced with an original unit obtained from **Ozak**.

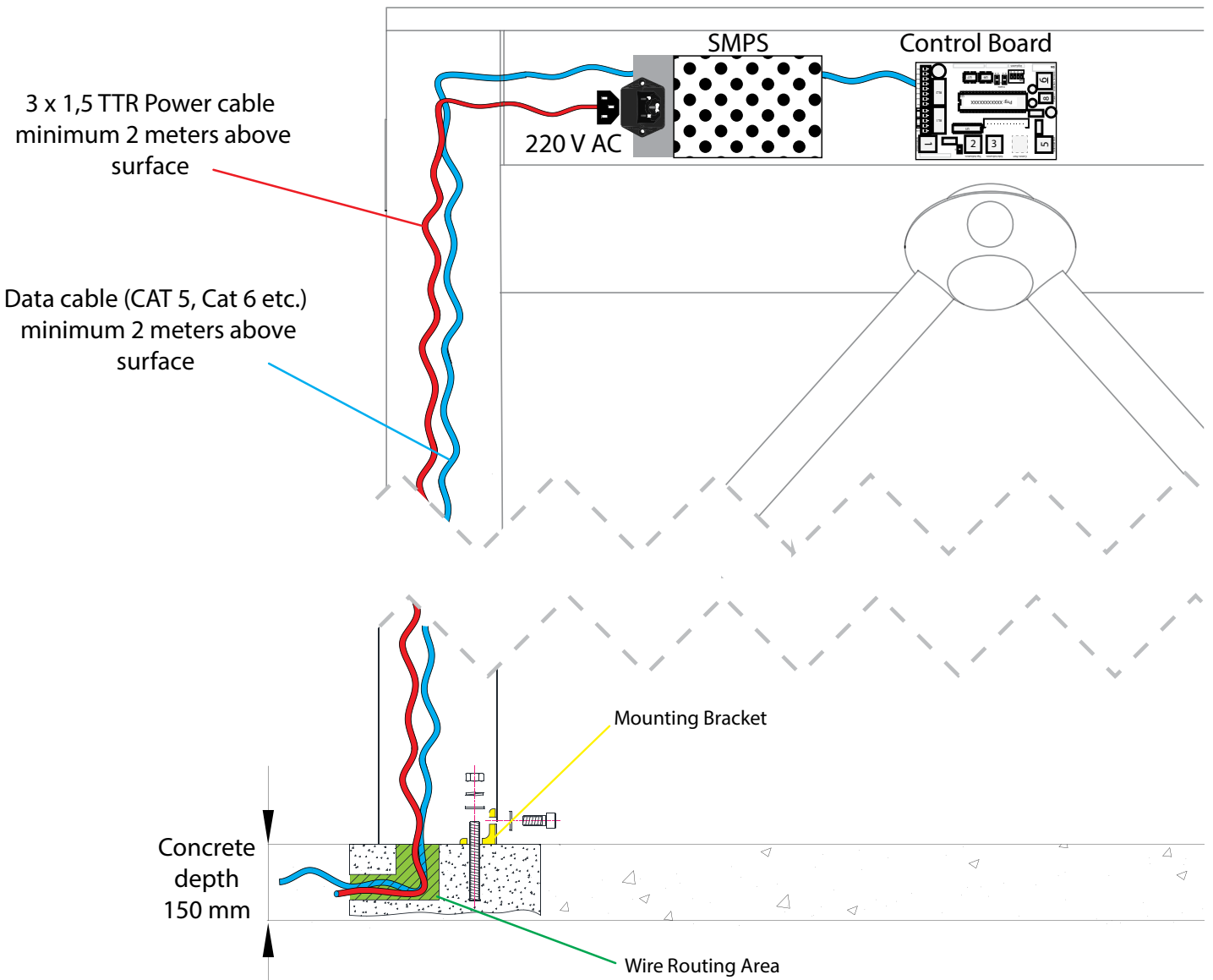

## 5.2 Control Board Inputs and Outputs

### For TRN 1203

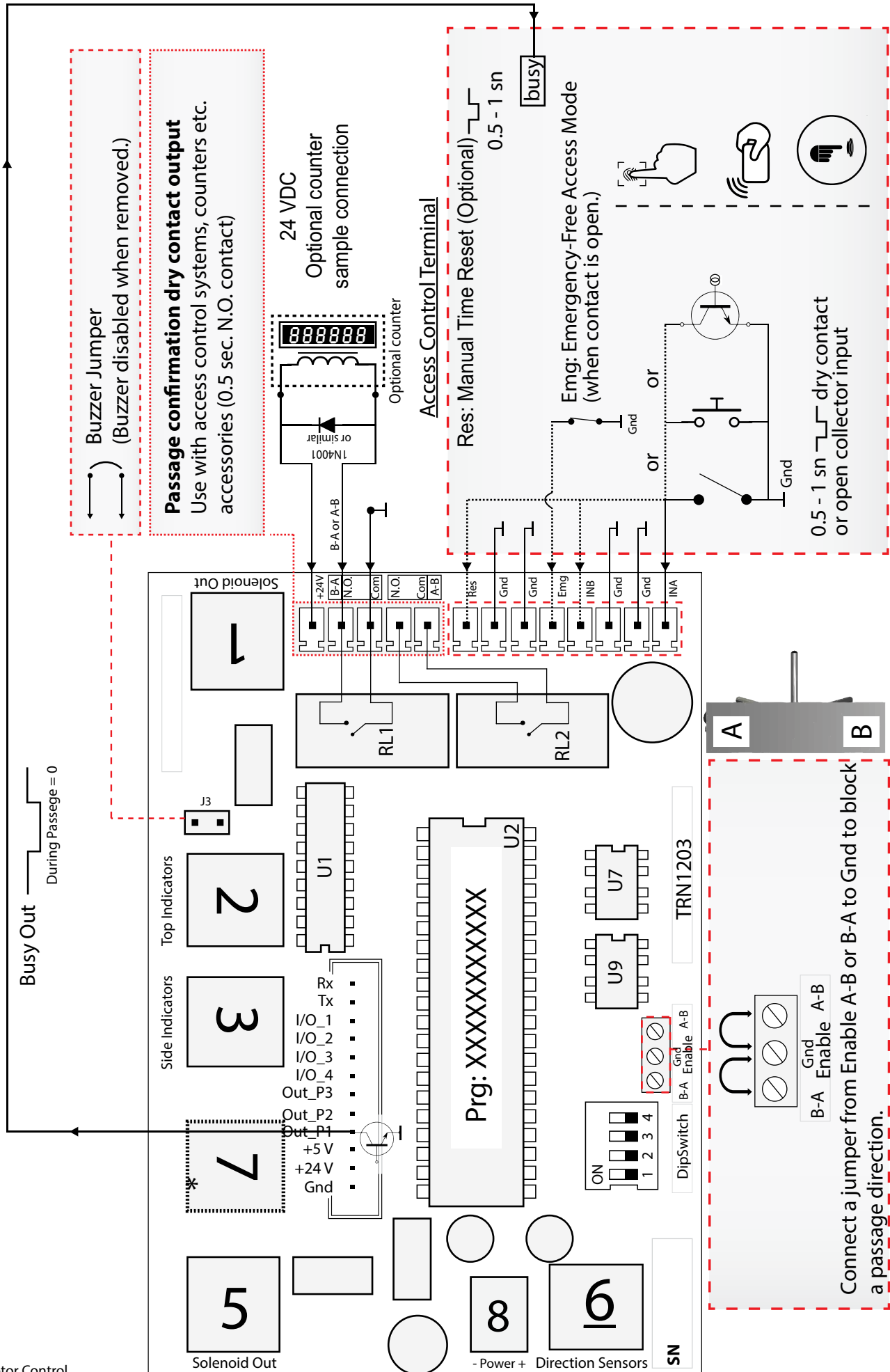

\*Motor Control (Motorized Models)

**Passage confirmation relay contact terminals;**  
Use with access control systems, counter etc.  
(500mS N.O. contact)

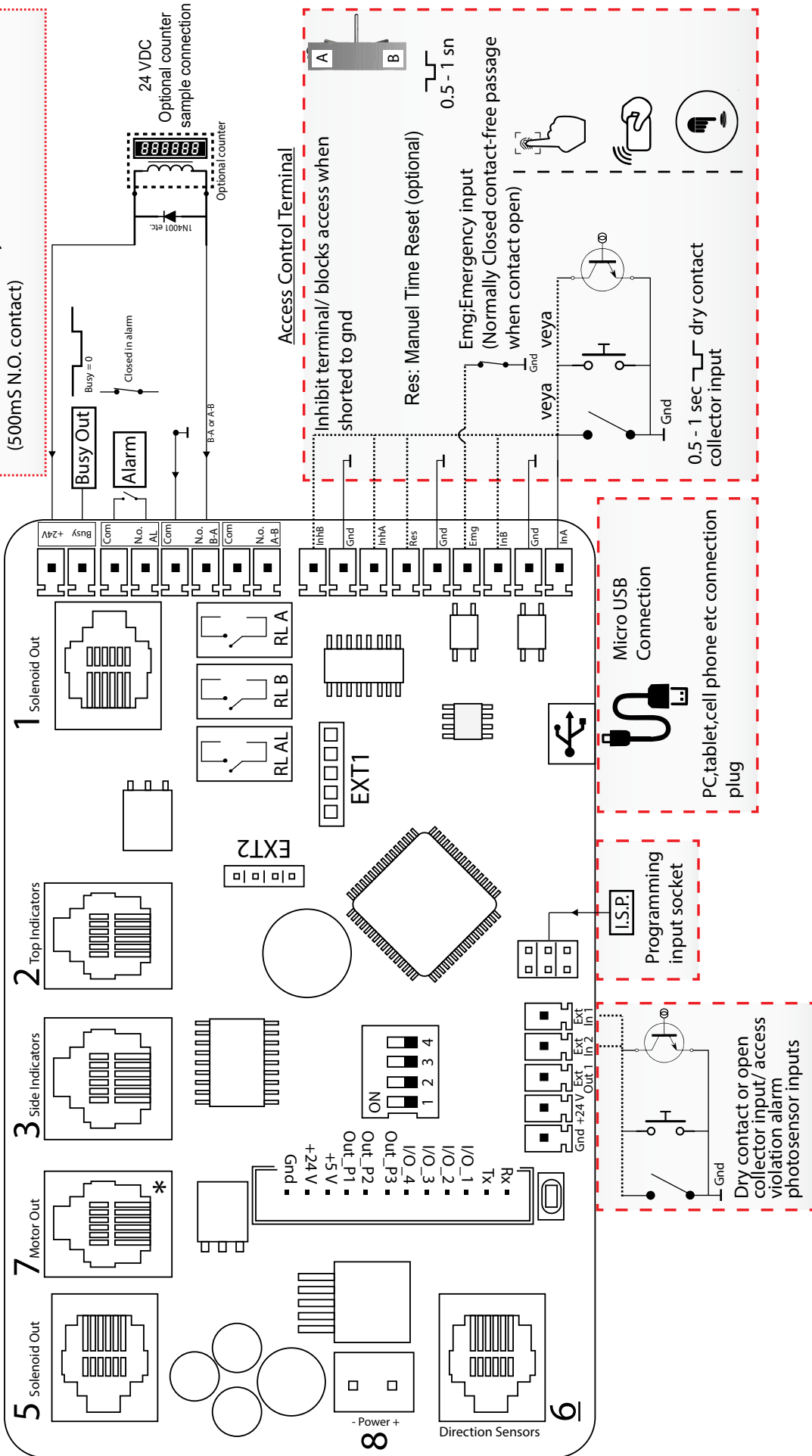

\*Motor Control  
(Motorized Models)

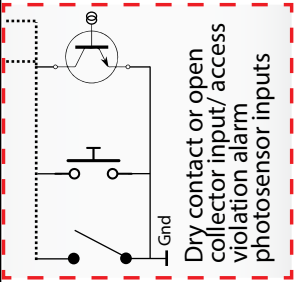
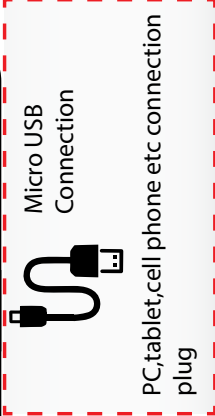
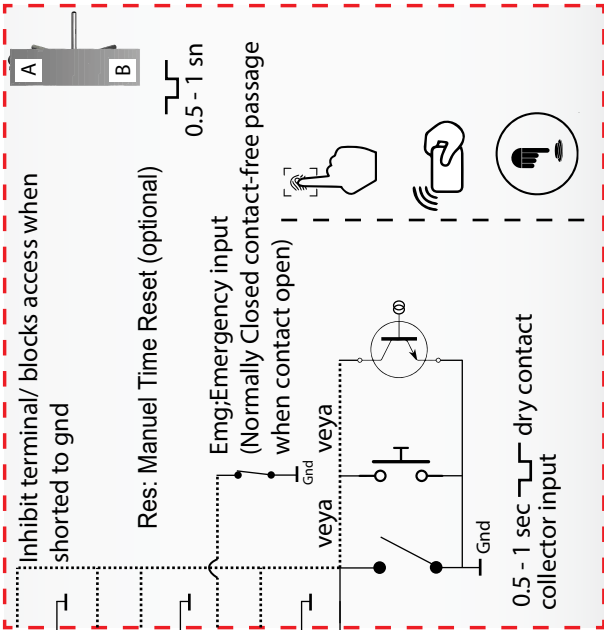

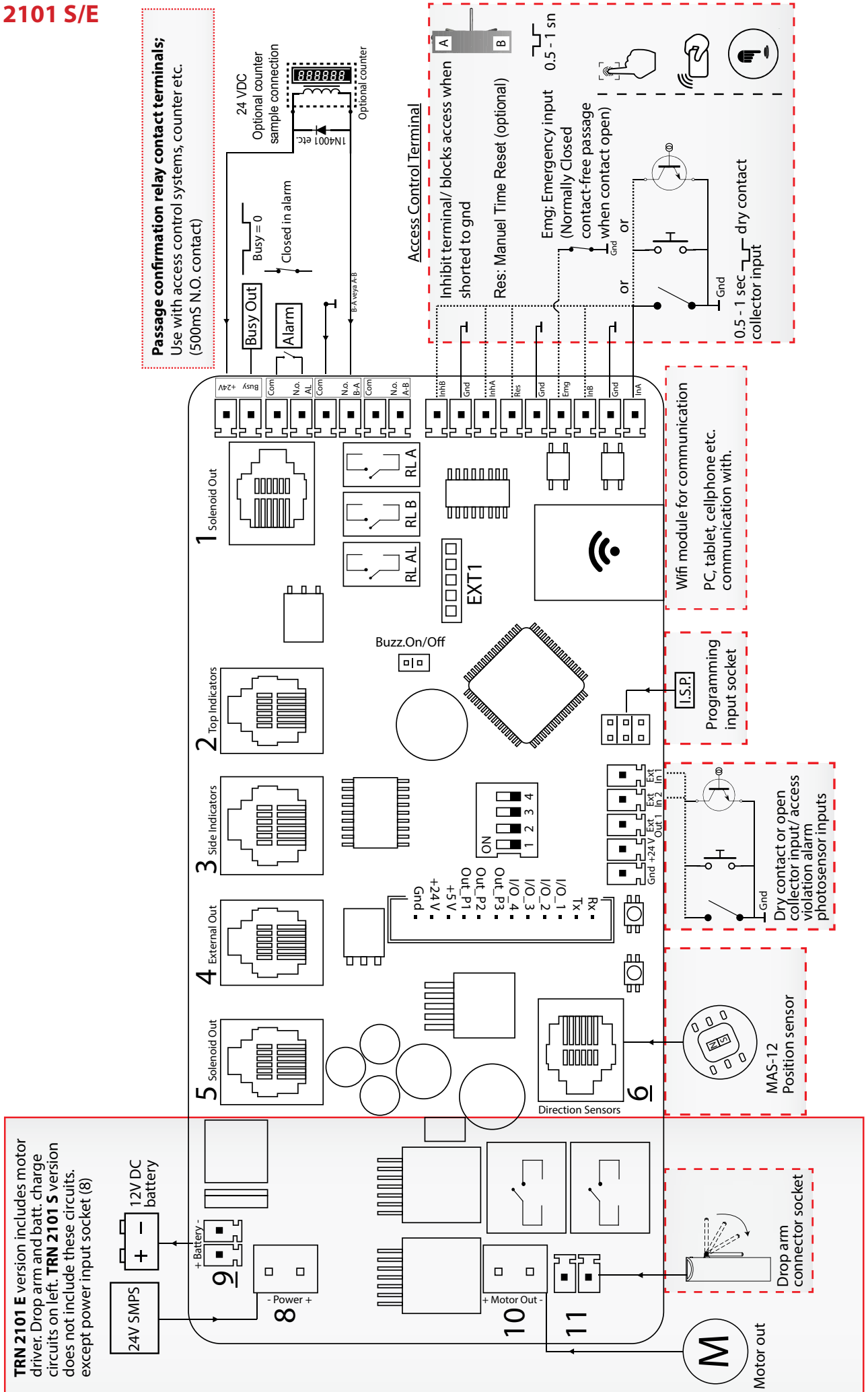

## 5.3 Control Board External Component Connections

### For TRN 1203

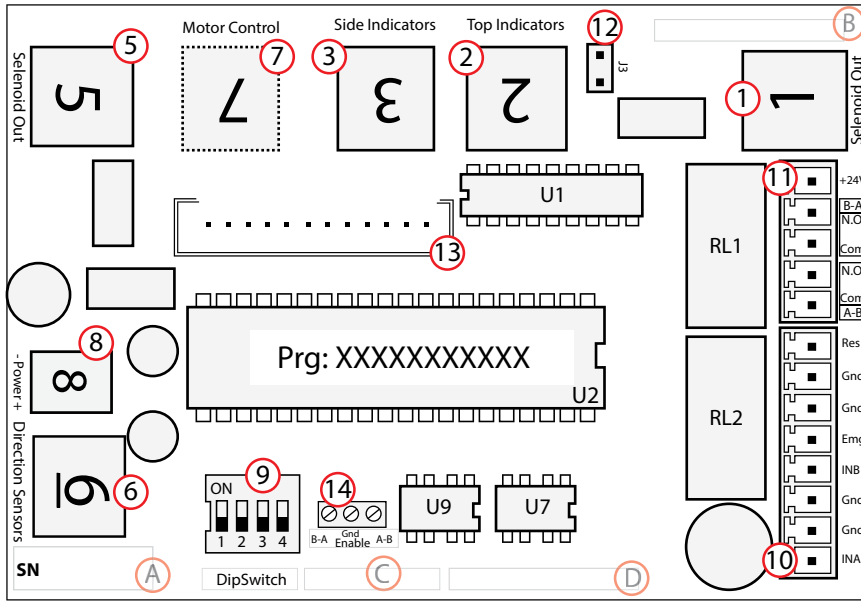

1. Solenoid A-B
  2. Top Passage Indicator and Buzzer
  3. Side indicators
  4. Optional Comm. Port
  5. Solenoid B-A
  6. Direction Photo Sensor
  7. Motor Control
  8. Power Input (24 VDC)
  9. Dip Switch
  10. Control Inputs
  11. Passage Confirmation Contact
  12. Buzzer Enable/Disable
  13. External Module Connector (Motor Driver, Drop Arm Control etc.)
  14. Inhibit Terminal
- 
- A. Board Serial Number
  - B. Stock Code
  - C. Production Number
  - D. Board Model

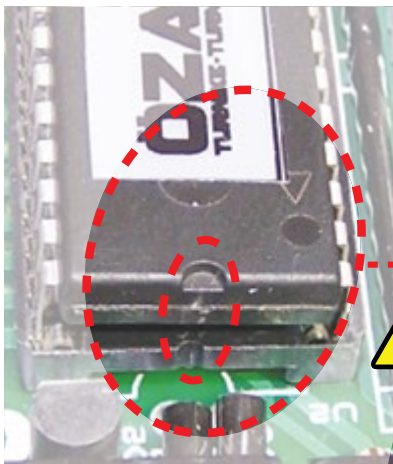

! Pay attention to pin markers when replacing microprocessors !

! Match socket and cable numbers when replacing boards and other parts !



# For TRN 1901

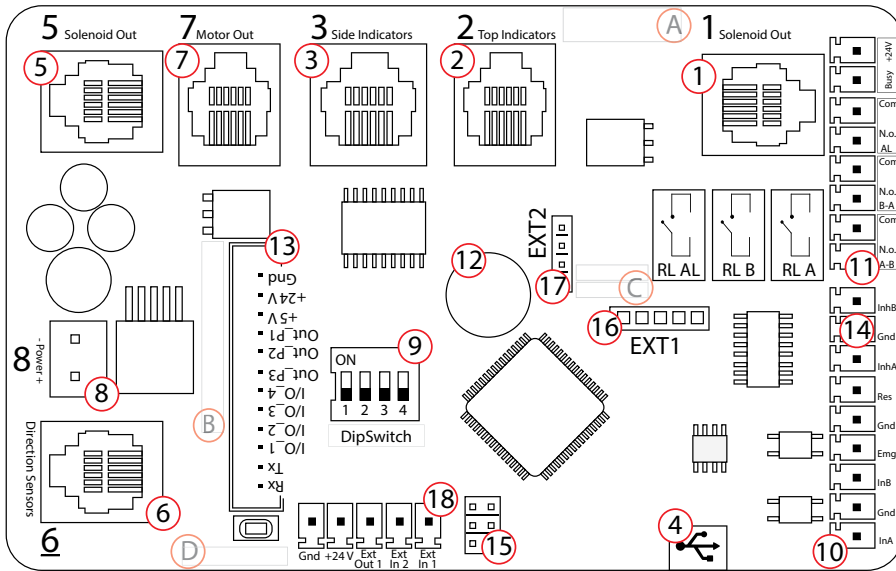

1. Solenoid A-B
2. Top Indicator
3. Side Indicator Outputs
4. USB Comm. Port
5. Solenoid B-A
6. Direction Photosensor Inputs
7. Motor Control (Motorized Models)
8. Power Input
9. Dip Switch
10. Control Inputs
11. Passage Feedback Relay Outputs
12. Buzzer
13. Auxiliary Modul Connections (Motor Drive, Drop Arm Control Board etc.)
14. Inhibit Terminal
15. ISP Connection
16. Extra Comms. Modul Connection
17. Extra Connector
18. Auxiliary Connector

- A. Board Serial Number
- B. Stock Code
- C. Production Number
- D. Board Model



Match socket and cable numbers when replacing boards and other parts !





# For TRN 2101 S/E

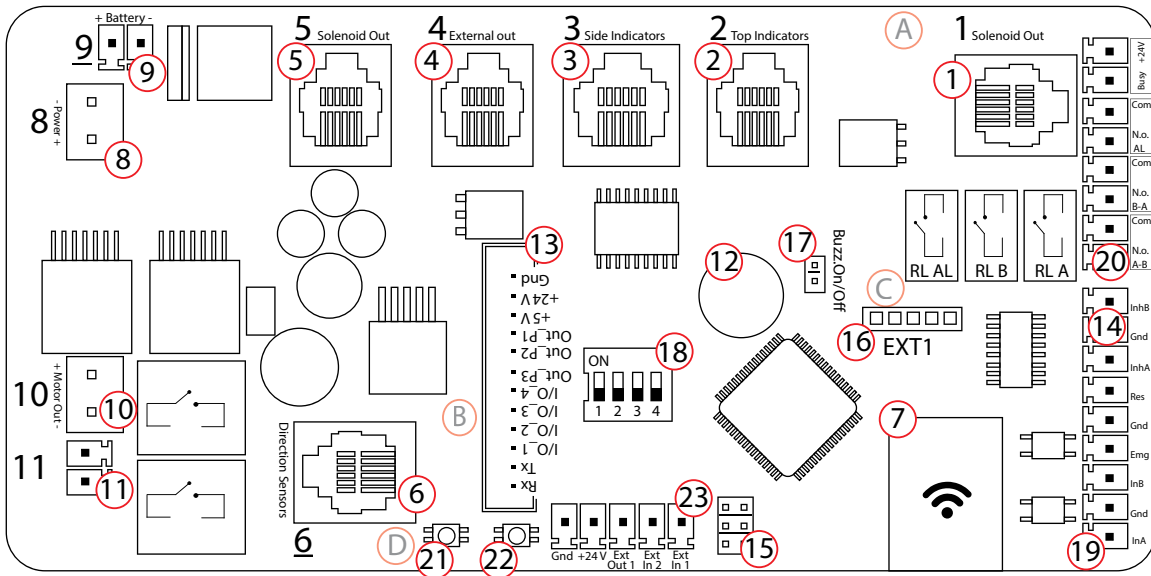

- |                                  |  |                                    |
|----------------------------------|--|------------------------------------|
| 1. Solenoid A-B                  | 11. Drop Arm Socket  | 19. Control Inputs                 |
| 2. Top Indicator                 | 12. Buzzer   | 20. Passage Feedback Relay Outputs |
| 3. Side Indicator Outputs        | 13. Auxiliary Modul Connections<br>(Motor Drive, Drop Arm Control<br>Board etc.) | 21. Service Button                 |
| 4. External Out                  | 14. Inhibit Terminal   | 22. Reset Button                   |
| 5. Solenoid B-A                  | 15. ISP Connection   | 23. Auxiliary Connector            |
| 6. Direction Photosensor Inputs  | 16. Extra Comms. Modul Connection<br>(RS 485 / 232 / TCP IP)                     |                                    |
| 7. Wifi Module For Communication | 17. Buzzer On/Off  | A. Board Serial Number             |
| 8. Power Input                   | 18. Dip Switch   | B. Stock Code                      |
| 9. Battery Socket                |  | C. Production Number               |
| 10. Motor Output Socket          |  | D. Board Model                     |

**!** Match socket and cable numbers when replacing boards and other parts !



# Wiring Diagram For AVIR 800 Only

## Operation Sequence

1. Check reader input (Normally Open)  
Note: If reader is not used, place jumper between In1 and Gnd
2. Check thermal scanner (NC contact opens for 2 sec. if temp. reading is within set range)  
Note: If thermal Scanner is not used, leave terminal In2 open
3. Check Left and Right hand sensors (Normally Closed-Open contact when hand inside)
4. Release turnstile for one passage (relay contact to IN A--Gnd terminals of turnstile control board)  
Note: System is inoperable when liquid level sensor output closes-Low level warning light ON.



TRN1901 TURNSTILE CONTROL BOARD

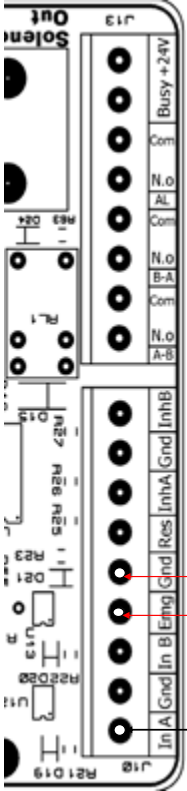

IFC1010 INTERFACE BOARD

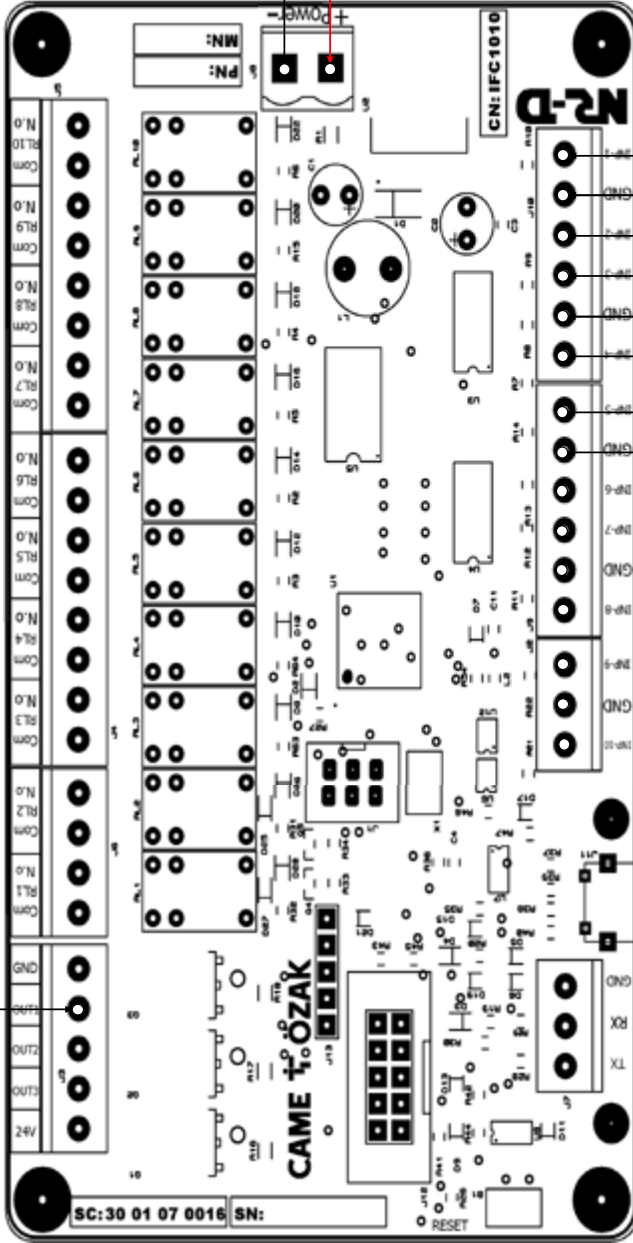

24VDC POWER SUPPLY



PROXIMITY CARD READER OR TURNSTILE INPUT



THERMAL SCANNER

Insert jumper into IN 1 and GND if reader is not used

2 sec. open if temp. ok

## 5.4 Control Board Settings

### 5.4.1 Blocking Passage Direction

#### For TRN 1203

To block entry into A or B direction, short enable pins (J4,J5). Turnstile will not allow passage in the blocked direction and indicator for that direction will turn red to show blocked access. This feature can be used with a metal detector to automatically block access for security purposes or setting the turnstile for one way traffic operation.

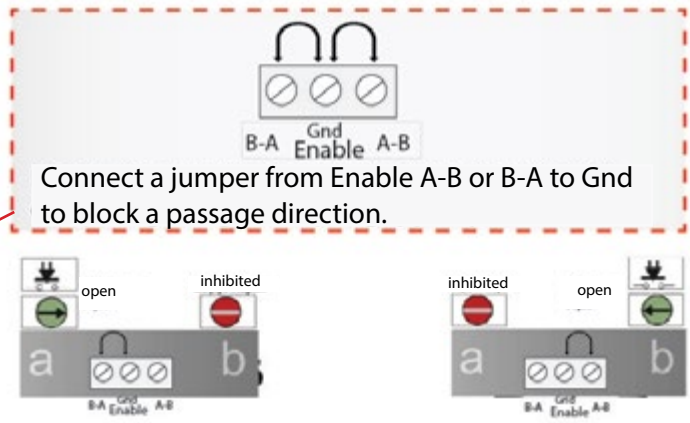
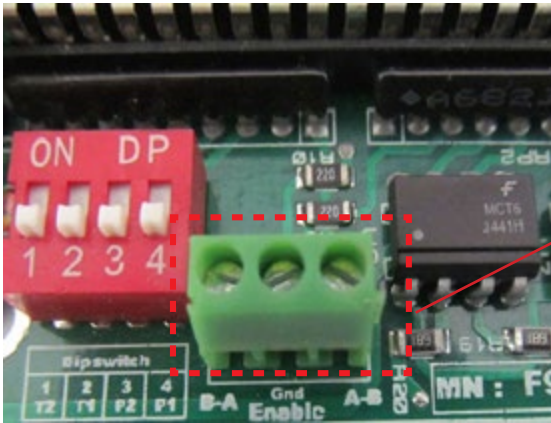

#### For TRN 1901 - For TRN 2101S/E

To block entry into A or B direction, short enable pins (J4,J5). Turnstile will not allow passage in the blocked direction and indicator for that direction will turn red to show blocked access. This feature can be used with a metal detector to automatically block access for security purposes or setting the turnstile for one way traffic operation.

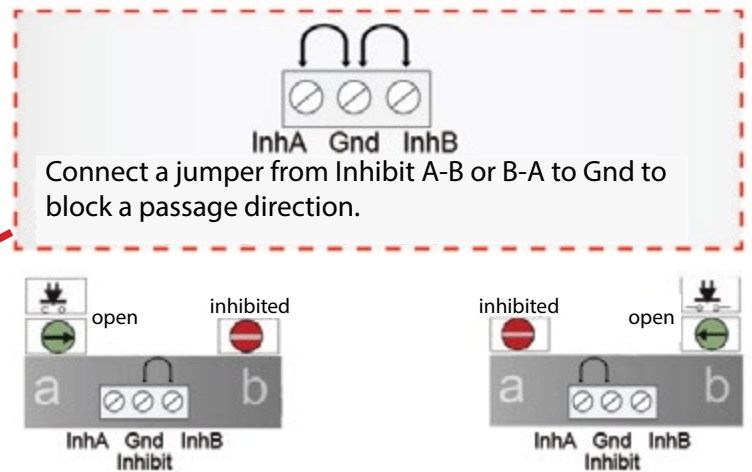
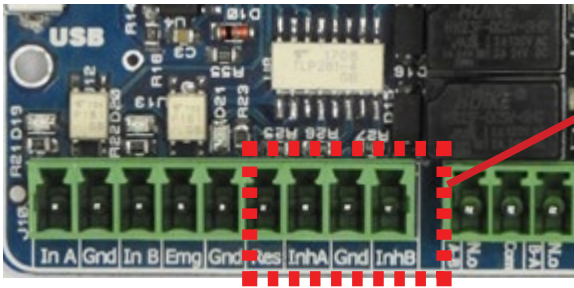

## 5.4.2 Dip Switch Settings

- **Tripod Turnstiles:** Time out and mode settings of the turnstile are selected by the dip switch located on the control board as explained below.

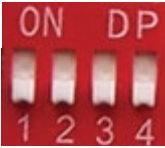
ON ↑ ↓ OFF		SWITCH NO	EXPLANATION
		1	TIME SETUP 1
		2	TIME SETUP 2
		3	PROGRAM SETUP 1
		4	PROGRAM SETUP 2

TIME SETUP		
DIPSWITCH		
1	2	TIME
OFF	OFF	6 sec.
ON	OFF	12 sec.
OFF	ON	18 sec.
ON	ON	INFINITY

FUNCTION (PROGRAM) SELECTION			
DIPSWITCH			
3	4	FUNCTION	DIAGRAM
OFF	OFF	Bi-directional operation	1
ON	OFF	B-A free, A-B controlled access	4
OFF	ON	Single input, activation in both directions	2
ON	ON	A-B free, B-A controlled access	3

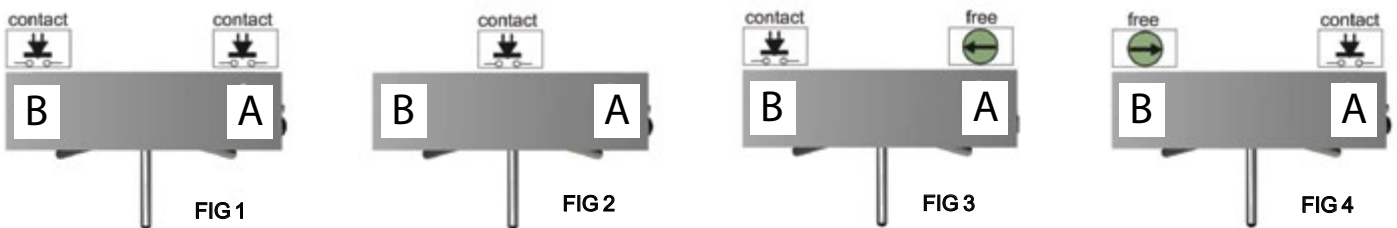

- FIG 1.** Bi-directional controlled passage: A card reader or button is used for each direction  
**FIG 2.** Bi-directional passage by a single control device: A single reader or button connected into In A allows passage in both directions  
**FIG 3.** A direction free, B direction controlled passage: Example: Controlled entry –free exit into a building.  
**FIG 4.** B direction free, A direction controlled passage

- **Wide Access/ DDA Models:** Switch number 2: Sets 'stay open' duration to 2 seconds. Default is 6 seconds.  
 Switch number 3: Sets emergency opening direction  
 Switch number 4: Allows open/ timeout reset -close commands by a single contact into In A or B. Panel closes without waiting for timeout period when input contact is repeated.  
**All other settings are as explained in table above**

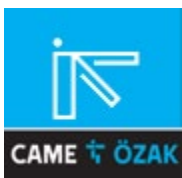

TSC Manager app allows quick access to turnstile settings with on/off switch options in the menu. TSC Manager application can be downloaded from google playstore which is available in all android phones. Scan the QR code on the right to download TSC Manager application.



## 5.4.3 Magnetic Encoder Arm Stop Settings

### TRN2101 Control Board / 3 and 4 Arm Turnstile Rotor Arms Centre Position Settings

#### System reset and service/ adjustment mode

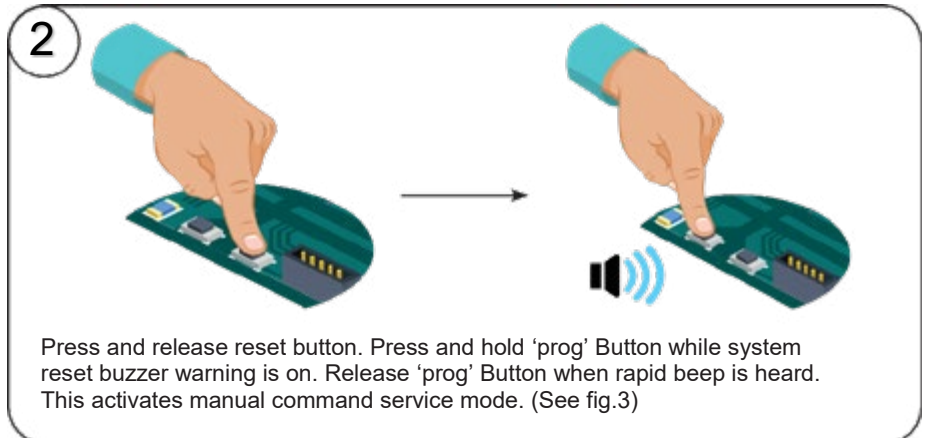
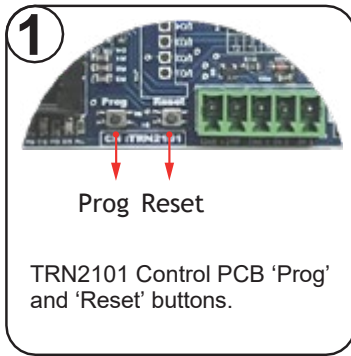

#### Single Button Setting Mode



#### Arm Position Setting

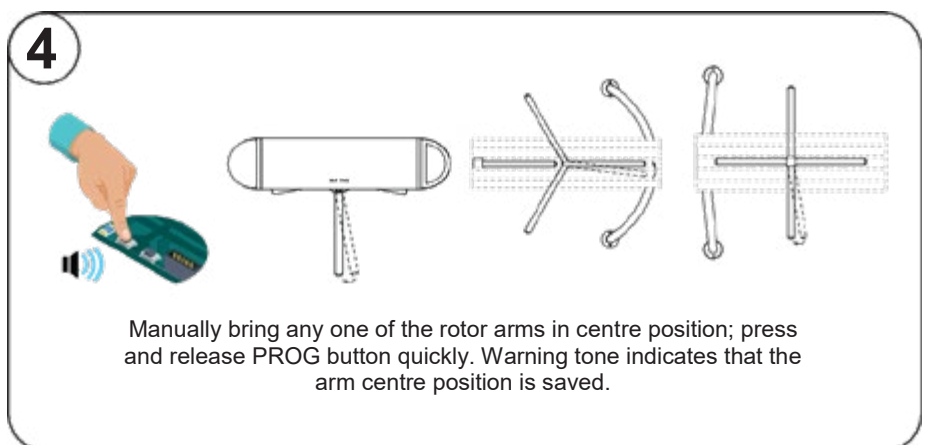

#### Setting Other Arm Positions

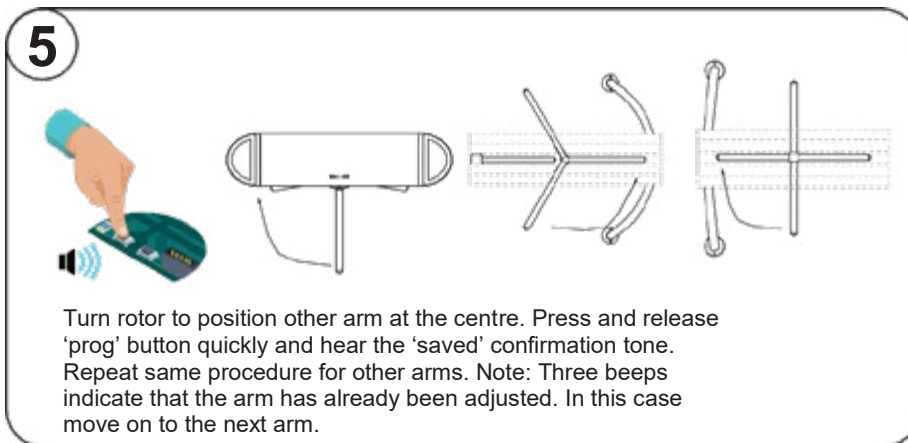

#### Saving Settings



#### Exiting Service Mode

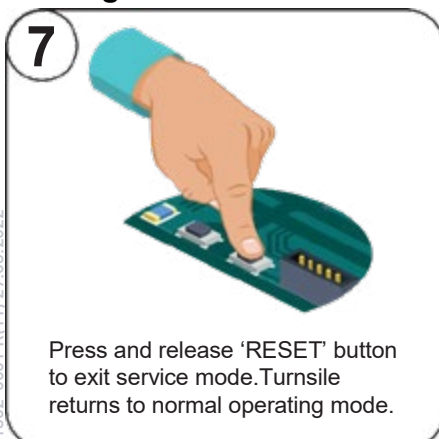

**System Reset and Service/ Adjustment Mode**

**1**



Prog Reset

TRN2101 Control PCB 'Prog' and 'Reset' buttons.

**2**

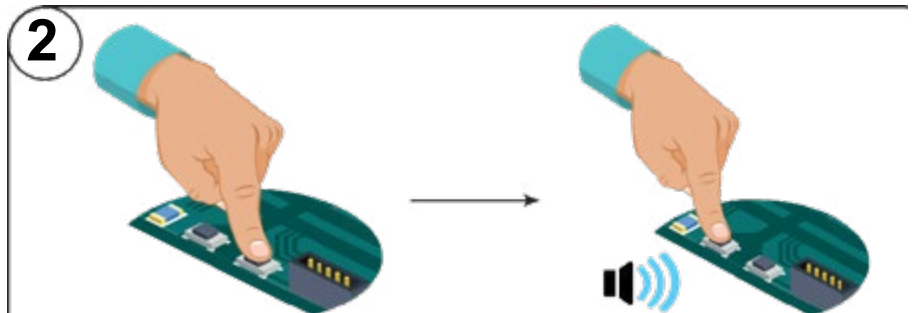

Press and release reset button. Press and hold 'prog' Button while system reset buzzer warning is on. Release 'prog' Button when rapid beep is heard. This activates manual command service mode. (See fig.3)

**Single Button Setting Mode**

**Wing Position Settings-Centre Position**

**3**



Press PROG button again and release when very rapid warning tone is heard.

**4**

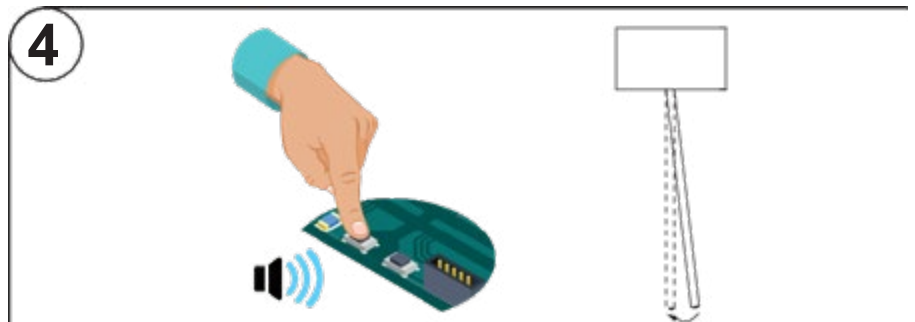

Manually bring wing in centre position; Press and release 'PROG' button quickly. Warning tone indicates that the arm centre position is saved.

**Wing Opening Stop Positions- Left**

**Wing Opening Stop Positions- Right**

**5**

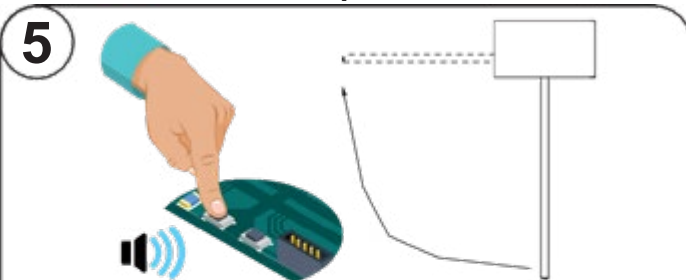

Manually open the wing to left stop position. Press and quickly release the 'PROG' button. Warning tone indicates that left side arm opening stop position is saved.  
**Note:** Three beeps indicate that the wing open position was already adjusted. In this case move on to the next setting.

**6**

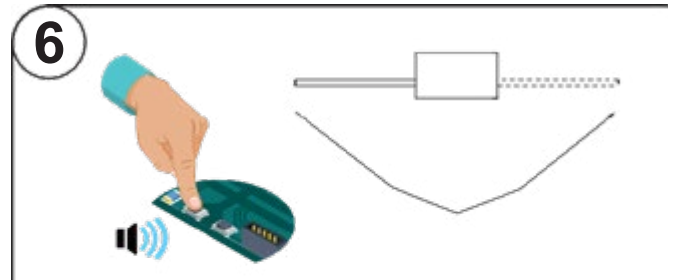

Manually open the wing to right stop position. Press and quickly release the 'PROG' button. Warning tone indicates that right side arm opening stop position is saved. **Note:** Three beeps indicate that the wing open position was already adjusted.

**Exiting Service Mode**

**7**



Press and release 'RESET' button to exit service mode. Gate returns to normal operating mode.

## 5.5 Hydraulic Damper Settings (Manual Models)

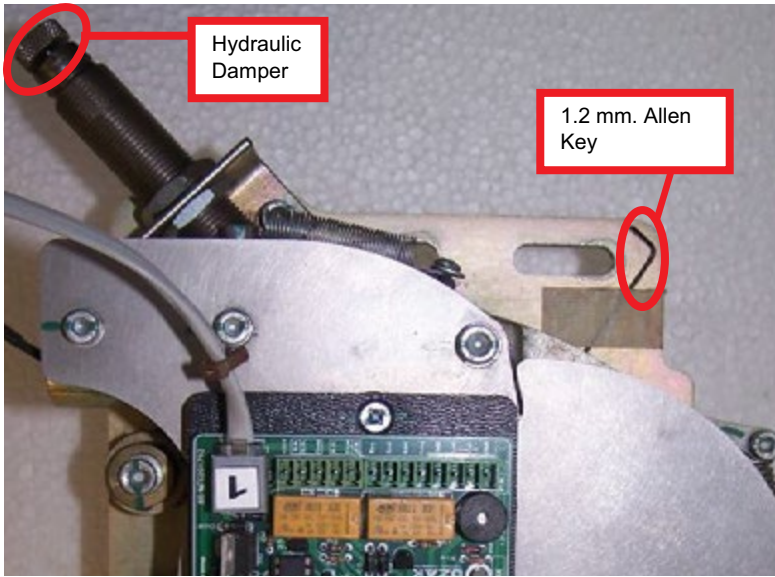

### Damper Adjustment:

Due to large variations in ambient temperature or wear, the hydraulic damper adjustment may be required. Example; in very cold temperatures damping should be reduced if the rotor can not quickly return to rest position following rotation. In warm areas, if the rotor fails to stop smoothly at the rest position and oscillates then the damping should be increased.

Before adjusting the damper, loosen the dial stop screw with 1.2 mm. Allen key taped on the mechanism.

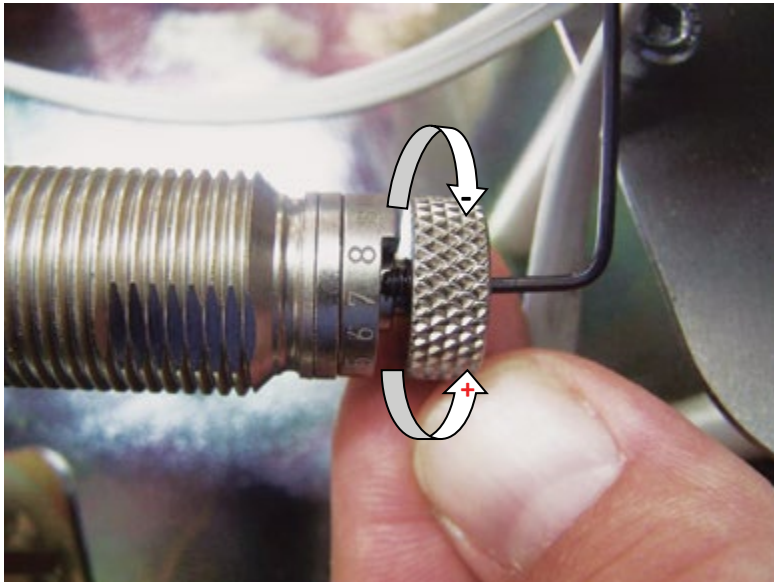

### Note:

Damping factor is increased when dial is turned clockwise.

Once the adjustment is done, tighten the stop screw while holding the dial steady with the other hand.

**Caution!** Dial is very sensitive. It must be adjusted carefully in small increments.

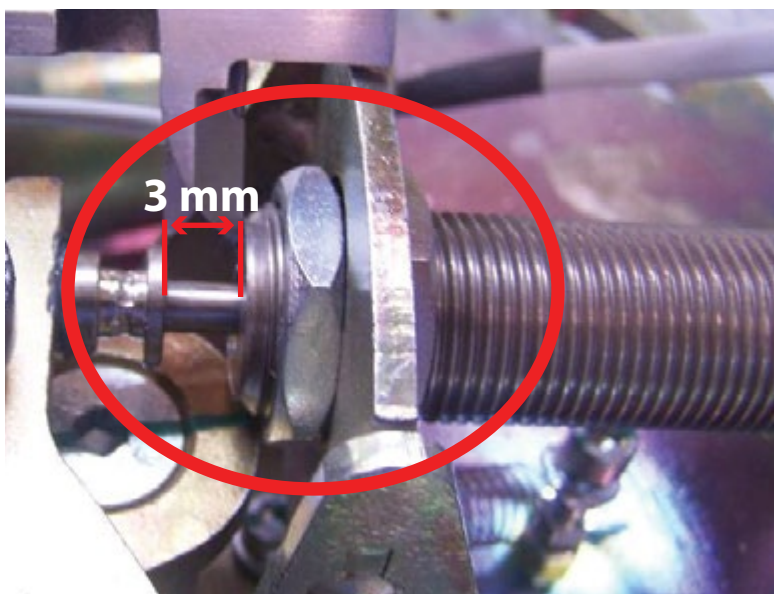

**Caution!** To prevent damage due to bottoming out of the damper during operation, ensure that there is approximately 3 mm. clearance between the damper head and the body when the damper arm is fully pushed in. Use loctite on damper mounting nuts to prevent loosening by vibration if clearance adjustment is performed.

## 6. POST INSTALLATION CHECKLIST

No	Item to Check	✓	Remarks
1	Installation surface is flat, even and sufficiently strong		
2	All wiring is routed and connected properly		
3	All AC power lines are properly insulated and grounded ⚠		
4	Turnstile is positioned and mounted correctly and firmly		
5	All anchoring bolts are secured in place with chemical plaster.		
6	All anchoring hardware tightened properly (no loose nuts/bolts etc).		
7	All arms, covers, panels, readers etc. are mounted correctly		
8	No physical damage or irregularities (dents, scratches, broken items etc.)		
9	When powered up all indicators are normal, solenoids locked, buzzer initial beep is heard, rotor/panel on standby position)		Depends on dip SW settings (see 5.4)
10	Turnstile allows passage in A direction when contact is given on Input A and Gnd. Opposite side indicator turns red until rotation complete.		
11	Turnstile allows passage in B direction when contact is given on Input B and Gnd. Opposite side indicator turns red until rotation complete.		
12	Turnstile rotor (or panel) operates quietly, smoothly and returns to center (standby) position.		
13	When Emg contact is given continuously turnstile allows free passage in both directions while buzzer is heard.		(Fixed arm version freewheels, drop arm drops, panel version fully opens)
14	When power is cut off, turnstile allows free passage by pushing		Arm drops automatically in drop arm models
15	⚠ AC potential between turnstile ground and neutral is less than 0.5V. Good continuity (0 Ohm) between chassis and ground.		Unit is properly grounded.

## 7. SERVICE AND MAINTENANCE

### 7.1 Maintenance Instructions

#### 7.1.1 Recommended User Maintenance

- Periodically wipe the turnstile exterior with a clean, damp and soft cloth to keep it free of dust.
- Inspect external mounting screws, panels, arms etc. once every three months or as required to ensure that there are no loose, worn out or damaged items. If there are loose or damaged items contact your authorized dealer or Ozak.
- Check that the turnstile is firmly anchored on the surface.( No loose or damaged anchoring).
- Check that all mechanical movement is smooth and quiet with no unusual noise, rattling etc.
- Inspect electrical cables and connections for any damage, water contamination, loose connections or wear. Contact your authorized dealer or the manufacturer if any problem is detected.
- Ozak uses only the finest quality certificated steel obtained from reputable suppliers for maximum corrosion resistance and strength. During our manufacturing process we take all the required steps to ensure that the finished products have excellent corrosion resistance. Depending on the environmental conditions, there may be staining issues on some turnstile surfaces in outdoor installations if regular cleaning and maintenance is not performed. On 304 and higher grade steel surfaces, these stains are not actual rust, but only accumulation of airborne particles sticking on the surfaces. These type of stains can be cleaned off and prevented by periodic maintenance recommended below.
- Cleaning the turnstile surfaces by wiping with a clean, dust and grit free absorbent cloth is effective in most cases. Harsh abrasives should never be used on polished metal surfaces. Commercially available appropriate metal polishing compounds can be used for removal of tougher stains. The recommended frequency of cleaning depends on the local environment as explained in table below.

Environment	Type 304	Type 316
Seafront	Frequently as required	Monthly
Coastal (Within 5 km of the coast)	Frequently as required	6-12 months
Industrial and urban	3-6 months	6-12 months
Suburban Rural	Annually or as required by experience	
Internal	As required to maintain appearance	



**Do not wash the turnstile with pressurized water.**

**There are no user serviceable items inside the turnstile. Do not attempt to do repair work such as lubrication, part replacement, adjustment inside the unit. All such work must be performed by qualified technical personnel only!**



## 7.1.2 Periodic Maintenance by Technical Service Personnel

400-500-600-700 SERIES TURNSTILES			
<b>General</b>	Cover and anchoring bolts	12 mth.	Check/ Tighten
	Cover, reader and indicator seals	12 mth.	Check
	Rotor head and mounting hardware	12 mth.	Check
<b>Mechanism</b>	Rotor shaft	12 mth.	Check + Lubricate
	Damper arm and bearing	12 mth.	Check
	Locking levers	12 mth.	Check
	Solenoids	12 mth.	Check
	Lock spring	12 mth.	Check
	Hydraulic damper	12 mth.	Check + Adjust
	Mechanical assembly fasteners	12 mth.	Check
	Bearings	12 mth.	Check
<b>Electronics</b>	Control Board	12 mth.	Check + Remove dust
	Directional Photosensor	12 mth.	Check + Remove dust
	Wiring and connectors	12 mth.	Check
	Indicators and buzzer	12 mth.	Check
WIDE ACCESS/ DDA TURNSTILES			
<b>General</b>	Cover and anchoring bolts	12 mth.	Check
	Cover, reader and indicator seals	12 mth.	Check
	Motor	12 mth.	Check
<b>Mechanism</b>	Motor pulley and drive belt	12 mth.	Check
	Rotor shaft	12 mth.	Check + Lubricate
	Solenoids	12 mth.	Check
<b>Electronics</b>	Control board	12 mth.	Check + Remove dust
	Directional photosensor	12 mth.	Check + Remove dust
	Wiring and connectors	12 mth.	Check
	Indicators and buzzer	12 mth.	Check

## 7.2 Trouble Shooting and Repair Guide (⚠️ Refer all repair work to qualified technical service personnel!)

Description of Fault	Possible Cause	Recommended Action
No power. (indicators, buzzer, locks off)	<ol style="list-style-type: none"> <li>1. No AC power supplied to unit</li> <li>2. Loose power cable</li> <li>3. Blown fuse</li> <li>4. Faulty power supply unit</li> </ol>	<ol style="list-style-type: none"> <li>1. Restore AC power</li> <li>2. Connect power cable</li> <li>3. Replace fuse (see 2.2)</li> <li>4. Replace power supply unit</li> </ol>
Rotor freewheels in both directions when power is on while buzzer sound is heard.	<ol style="list-style-type: none"> <li>1. Emergency input jumper or relay contact is open (if indicators are green).</li> <li>2. Loose or faulty photosensor in mechanism (if indicators are red with periodic beep).</li> <li>3. Faulty control board.</li> </ol>	<ol style="list-style-type: none"> <li>1. Connect Emg. jumper or NC alarm relay on Emg-Gnd.</li> <li>2. Tighten, repair sensor connection/ Replace sensor.</li> <li>3. Replace control board.</li> </ol>
Turnstile does not allow passage when input contact is given-buzzer heard	<ol style="list-style-type: none"> <li>1. Restricted lock lever movement (due to foreign object such as cable, gummed lubricant etc)</li> <li>2. Sticky solenoid</li> <li>3. Faulty control board</li> <li>4. Misaligned/bent photosensor in motorized units</li> </ol>	<ol style="list-style-type: none"> <li>1. Repair lever mechanism</li> <li>2. Replace solenoid</li> <li>3. Replace control board</li> <li>4. Adjust photosensor (motorized units)</li> </ol>

Description of Fault	Possible Cause	Recommended Action
Rotor/arms do not return to center (standby) position following a passage	<ol style="list-style-type: none"> <li>1. Loose or broken clamp spring</li> <li>2. Over damped hydraulic damper setting</li> </ol>	<ol style="list-style-type: none"> <li>1. Re-install / replace clamp spring</li> <li>2. Adjust hydraulic damper (see 5.5)</li> </ol>
Rotor bounces back and forth following a rotation, fails to settle in rest position smoothly	<ol style="list-style-type: none"> <li>1. Under damped hydraulic damper setting</li> <li>2. Worn out / faulty hydraulic damper</li> </ol>	<ol style="list-style-type: none"> <li>1. Adjust hydraulic damper (see 5.5)</li> <li>2. Replace and adjust hydraulic damper</li> </ol>
Turnstile fails to lock/ free wheels following passage	<ol style="list-style-type: none"> <li>1. Dislocated, broken lock lever</li> <li>2. Solenoid failure</li> <li>3. Loose or faulty photosensor</li> </ol>	<ol style="list-style-type: none"> <li>1. Repair/replace lock lever</li> <li>2. Replace solenoid</li> <li>3. Re-connect, replace photosensor</li> </ol>
Rotor gets stuck intermittently during rotation	<ol style="list-style-type: none"> <li>1. Loose or broken ratchet spring</li> </ol>	<ol style="list-style-type: none"> <li>1. Re-install/ replace spring</li> </ol>
No response to input/reader device. No access	<ol style="list-style-type: none"> <li>1. Loose/incorrect reader connection</li> <li>2. Reader fault</li> <li>3. Faulty control board</li> </ol>	<ol style="list-style-type: none"> <li>1. Check/repair reader connections</li> <li>2. Replace faulty reader/input device</li> <li>3. Replace control board</li> </ol>
No passage confirmation contact out of control board	<ol style="list-style-type: none"> <li>1. Loose connection at output terminal</li> <li>2. Faulty control board</li> </ol>	<ol style="list-style-type: none"> <li>1. Repair connection</li> <li>1. Replace control board</li> </ol>
Turnstile freewheels in one direction	<ol style="list-style-type: none"> <li>1. Dip switch 3,4 might be set for free passage (see.5.4.2)</li> <li>2. Loose solenoid connector</li> <li>3. Loose lock lever spring</li> <li>4. Stuck/ broken lock lever</li> </ol>	<ol style="list-style-type: none"> <li>1. Set dip switches 'off'</li> <li>2. Re-insert connector</li> <li>3. Repair/ replace lock lever</li> </ol>
Arm fails to drop in emg mode or when power is cut off. (Drop arm equipped models)	<ol style="list-style-type: none"> <li>1. Depleted/ weak 12V battery</li> <li>2. Loose battery connector</li> <li>3. Loose drop arm driver board-motor connection</li> <li>4. Jammed drop arm locking mechanism</li> </ol>	<ol style="list-style-type: none"> <li>1. Recharge/replace battery</li> <li>2. Restore battery connection</li> <li>3. Repair/tighten loose connection</li> <li>4. Repair jammed mechanism</li> </ol>
Arm fails to lock in place/ drops by itself (drop arm equipped models)	<ol style="list-style-type: none"> <li>1. Jammed arm locking mechanism</li> <li>2. Loose/ deformed arm lock spring</li> <li>3. Damaged/worn arm locks</li> </ol>	<ol style="list-style-type: none"> <li>1. Repair jammed mechanism</li> <li>2. Repair/replace spring</li> <li>3. Replace arm locks</li> </ol>
Turnstile unlocks upon input but motor does not work (motorized models)	<ol style="list-style-type: none"> <li>1. Loose motor/motor driver board connection</li> <li>2. Tripped motor driver protection circuit breaker (2xgreen leds lit) or blown fuse</li> <li>3. Faulty motor driver board</li> <li>4. Faulty motor</li> </ol>	<ol style="list-style-type: none"> <li>1. Repair/ tighten connection</li> <li>2. Do a power off reset/ replace blown fuse</li> <li>3. Replace motor driver board</li> <li>4. Replace motor</li> </ol>
Motorized rotor/ panel keeps moving/ fails to stop in middle position.	<ol style="list-style-type: none"> <li>1. Loose photosensor connector</li> <li>2. Misaligned, bent or contaminated photosensor</li> <li>3. Faulty photosensor</li> </ol>	<ol style="list-style-type: none"> <li>1. Repair/tighten photosensor connector</li> <li>2. Adjust/ clean photosensor</li> <li>3. Replace photosensor</li> </ol>
Motorized panel opens slowly and times out on return/ alarm activated	<ol style="list-style-type: none"> <li>1. Too low motor speed setting on motor driver board</li> <li>2. Loose or oil contaminated drive belt</li> </ol>	<ol style="list-style-type: none"> <li>1. Increase motor speed (turn speed control ccw direction) on motor driver board</li> <li>2. Clean/ tighten drive belt</li> </ol>

## 8. LIST OF REPLACEMENT SPARE PARTS

### 8.1 Waist Height Model Turnstiles

Number	Part Code	Description	Standard	Motorized	Drop Arm	Motorized Drop Arm
1	45 00 00 0002	Arm (Stainless Steel)			✓	✓
2	20 03 01 0007	Arm (Stainless Steel)	✓	✓		
3	20 02 02 0323	Arm Cap (Stainless Steel)	✓	✓	✓	✓
4	10 01 38 0001	Battery			✓	✓
5	20 02 07 0007	Clamp Spring	✓		✓	
6	30 01 14 0001	Direction Photosensor (TDS23T+30)	✓	✓	✓	✓
7	30 01 04 0003	Drop Arm Board			✓	✓
8	10 01 34 0005	Drop Arm Motor			✓	✓
9	a) 30 01 01 0025	TRN1203	✓	✓	✓	✓
	b) 30 01 01 0028	TRN1901	✓	✓	✓	✓
	c) 30 01 01 0032/30 01 01 0034	TRN2101S/E	✓	✓	✓	✓
10	10 02 00 0001	Hydraulic Damper	✓		✓	
11	10 00 10 0003	Hydraulic Damper Bearing (698)	✓		✓	
12	*Code Varies with Serial Number	Indicator	✓	✓	✓	✓
13	20 02 07 0028	Lock Lever	✓		✓	
	20 02 03 0062	Lock Lever		✓		✓
14	10 01 23 0001	Microprocessor**	✓	✓	✓	✓
15	30 01 16 0005	Motor (24V DC / 35W)		✓		✓
16	10 04 19 0005	Motor Belt		✓		✓
17	30 01 03 0012	Motor Control Board (MC 24 SM)		✓		✓
18	20 02 03 0006	Polyamide Rotor Head	✓		✓	
19	20 02 03 0007	Rotor Head Cap	✓		✓	
20	45 00 00 0003	Rotor Mounting Set	✓		✓	
21	10 01 35 0017	SMPS (50W / 24V)	✓		✓	
22	10 01 35 0013	SMPS (100W / 24V)		✓		✓
23	30 01 10 0003	Solenoid (5V)	✓	✓	✓	✓
24	30 01 11 0004	Top Indicator (Type 1)	✓	✓	✓	✓
25	30 01 02 0121	Top Indicator (Type 2)	✓	✓	✓	✓
26	30 01 05 0050	Magnetic Encoder**	✓	✓	✓	✓

\*\*Units with magnetic encoder do not include direction photosensor (ref 1)

**⚠ Use only original Ozak replacement parts!**



## 8.2 Wide Access / DDA Models - Turnstiles For Reduced Mobility

Number	Part Code	Description	605	605 D	705 E / 705 E N1	705 E D / 705 E D N1	715 E	715 B
1	30 01 14 0001	Direction Photosensor (TDS23T+30)	✓	✓	✓	✓	✓	✓
2	a) 30 01 01 0025	TRN1203	✓	✓	✓	✓	✓	✓
	b) 30 01 01 0028	TRN1901	✓	✓	✓	✓	✓	✓
	c) 30 01 01 0032/30 01 01 0034	TRN2101S/E	✓	✓	✓	✓	✓	✓
3	*Code Varies with Serial Number	Indicator	✓	✓	✓	✓	✓	✓
4	20 02 07 0027	Lock Lever	✓	✓	✓	✓	✓	✓
5	20 02 00 0080	Main Rotor Shaft	✓	✓	✓	✓	✓	✓
	20 02 12 0508	Main Rotor Shaft						
6	10 01 23 0001	Microprocessor**	✓	✓	✓	✓	✓	✓
7	30 01 16 0003	Motor (for 605)	✓	✓				✓
	30 01 16 0004	Motor (for 705)			✓	✓	✓	
8	10 04 19 0001	Motor Belt	✓	✓	✓	✓	✓	✓
9	30 01 03 0012	Motor Control Board (MC 24-24SM)	✓	✓	✓	✓	✓	✓
10	00 04 00 0006	Panel Holder Clamp	✓	✓	✓	✓	✓	✓
11	10 01 35 0013	SMPS (100W / 24V)	✓	✓	✓	✓	✓	✓
12	30 01 10 0003	Solenoid (5V)	✓	✓	✓	✓	✓	✓
13	30 01 11 0004	Top Indicator ( Type 1)	✓	✓	✓	✓	✓	✓
14	30 01 02 0021	Top Indicator ( Type 2)	✓	✓	✓	✓	✓	✓
15	30 01 05 0050	Magnetic Encoder**	✓	✓	✓	✓	✓	✓

\*\*Units with magnetic encoder do not include direction photosensor (ref 1)

**⚠ Use only original Ozak replacement parts!**



\* Please provide model and serial number of the turnstile when ordering parts.

\*\*Specify firmware code for microprocessor orders !

Parts may vary according to model and manufacturing date !



# Warranty Certificate

**BRAND NAME** : .....

**MODEL** : .....

**DATE OF DELIVERY** : .....

**WARRANTY PERIOD** : .....

**SERIAL NUMBER** : .....



TS EN ISO 9001 : 2015

**MANUFACTURER** : ÖZAK GEÇİŞ TEKNOLOJİLERİ SANAYİ TİC A.Ş.  
**ADDRESS** : Çuhane CD. NO: 130 41080 KÖSEKÖY / KOCAELİ / TURKEY  
**PHONE&FAX** : +90 262 373 48 48 Pbx.  
**E-MAIL** : ozak@ozak-t.com  
**WEB** : www.ozak-t.com



## 9.2 Warranty Terms and Conditions

---

1. Warranty period starts after the date of purchase of the goods and continues for twenty-four (24) months against manufacturing defects. Warranty coverage is in form of supplying replacement parts free of charge.
2. Availability of the spare parts by the manufacturing company is guaranteed for ten (10) years following the manufacturing date of the product.
3. Any tampering, failures resulting from unauthorized modification or repair attempt and shall void the warranty.
4. Expiration time for the warranty of the parts replaced within the warranty period is the same as that of the product.
5. When the product fails within the warranty period, duration of repair is added to the warranty period.
6. Manufacturing company supplies required replacement parts to repair defects and failures during the warranty period in accordance with the terms stated herein. The parts are supplied to the authorized dealer/service center which has sold the product to end user.
7. It is the user's responsibility to check that technical services are carried out in accordance with the terms stated herein.
8. The user must retain the warranty certificates, serial numbers and present to the authorized service personnel when required. Serial number is required when replacement parts are ordered from the manufacturer.
9. Users are expected to sign the failure report/service forms that are filled after service/maintenance work performed under the warranty coverage.
10. In case any dispute or problem related to the warranty is not resolved by the manufacturer, users can apply to the Republic of Turkey Ministry of Industry and Trade, Directorate General of Protecting Consumer Rights and Competition.
11. All replacement parts sold by Ozak are warranted for a period of one year following the date of purchase, excluding failures resulting from physical damage, incorrect installation, misuse, tampering and similar reasons beyond manufacturers control.
12. The specified warranty periods and MCBF's of our products are based on the condition that the product is properly installed, operated and maintained in accordance to the recommended periodic maintenance plan of the manufacturer as outlined in the relevant technical documentation of the product. Such documentation is provided with the product or it can be obtained from the manufacturer.

## 9.3 Cases Excluded from the Coverage of Warranty

---

1. Any tampering or damage on warranty certificate or serial numbers and labels that prevent the identification of the product.
2. Any modifications, addition of accessories and parts, or replacement of parts without approval of manufacturer fall within the scope of tampering with the system, therefore terminates liability of the manufacturing company.
3. Warning signs, stickers, scratches, paint damage, wear and tear, externally caused stains etc.
4. Any damage and failure resulting from any of the conditions listed below are not covered by warranty:
  - a. Misuse, abuse, deliberate act or negligence,
  - b. Any damage, scratches or breakage of glass, acrylic, polycarbonate etc. parts,
  - c. Failures caused by improper installation, wiring, isolation, short circuit, power surge, incorrect wiring and voltage applications, improper grounding, change of phase group, induction current effects,
  - d. Maintenance, repair, additions or replacement of parts and accessories or moving the turnstiles from original place by unauthorized personnel or company, and lack of periodic maintenance of the product,
  - e. Shipping and handling and installation related damages,
  - f. Failures caused by exposure to unsuitable operating/environmental conditions for the stated technical specifications of the product (intended use, temperature range, IP grade etc.),
  - g. Failures caused by leakage of water into the internal parts of the product due to application of pressurized water, unauthorized modification, improper installation,
  - h. Damage and failure caused by lightning, flood, fire, storm, hurricanes, earthquake and similar natural disasters,
  - i. Accidents that occur at the location where the products are installed,
  - j. Damages/failures caused by pests such as rodent damage to wiring,
  - k. Damages that occur as a result of circumstances beyond reasonable control of the manufacturer or the user (armed conflicts, civil unrest, blockade, revolution, insurrection, mobilization, looting etc.),
  - l. THE DAMAGE OR FAILURES OCCURRING DUE TO FEEDING OF EXTERNAL DEVICES (CARD READERS, TERMINALS, INDICATIONS, COMMUNICATION DEVICES, ETC.) FROM THE CONTROL BOARD OR POWER SUPPLY UNIT INSIDE THE TURNSTILE.

## 9.4 CE Declaration of Conformity

### CE UYGUNLUK DEKLARASYONU / CE DECLARATION OF CONFORMITY



**ÜRETİCİ FİRMA/  
MANUFACTURER COMPANY** : ÖZAK GEÇİŞ TEKNOLOJİLERİ SANAYİ TİC. A.Ş.  
**ADRES/ADDRESS** : ÇUHANE CAD. NO: 130 41080 KÖSEKÖY/KOCAELİ/TÜRKİYE

Aşağıda adı geçen ürünlerin üretimi, kontrolü ve son değerlendirmeleri ÖZAK tarafından gerçekleştirilmektedir.  
*Manufacturing, control and final assessment of the below mentioned products are done by ÖZAK.*

#### ÜRÜN LİSTESİ/LIST OF PRODUCTS

**Açıklamalar/Explanations:** TURNİKELER (BEL TİPİ TURNİKELER / BOY TİPİ TURNİKELER / HIZLI GEÇİŞ TURNİKELERİ /  
ENGELLİ GEÇİŞ TURNİKELERİ / YÜKSEK GÜVENLİK TURNİKE VE KAPILARI / YARIM BOY TURNİKELER /  
GEÇİŞ KAPILARI / SPC ÖZEL DİZAYN TURNİKELER / SERBEST GEÇİŞ TURNİKELER )

TURNSTILES ( WAIST HEIGHT TURNSTILES / FULL HEIGHT TURNSTILES /  
SPEED GATES TURNSTILES / REVOLVING WING GATES TURNSTILES /  
SECURITY DOORS AND TURNSTILES / HALF HEIGHT TURNSTILES / PEDESTRIAN GATES /  
SPECIAL DESIGN TURNSTILES / FREE PASSAGE (RETAIL LINE) TURNSTILES )

#### İlgili Direktifler/Relevant Directives:

(2006/42/EC) Makine Emniyet Yönetmeliği / *Machine Safety Directive*,  
(2014/30/EU) Elektromanyetik Uyumluluk Yönetmeliği / *Electromagnetic Compatibility Directive*

HARMONİZE STANDARTLAR'a Göre Uygulanmış Yönetmelikler/  
Regulations applied according to HARMONIZED STANDARDS :EN ISO 12100:2010, EN 60204-1:2018, EN ISO 13857:2008,  
EN ISO 14120:2015, EN 349:1993/A1:2008, EN 61000-6-1:2019,  
EN 61000-6-3:2007/A1:2011/AC:2012

ÖZAK GEÇİŞ TEKNOLOJİLERİ SANAYİ TİC. A.Ş. yukarıda listesi verilen ürünlerin 2006/42/EC Makine Yönetmeliği ile 2014/30/EU Elektromanyetik Uyumluluk Yönetmeliği ve ilgili harmonize standartların gerekliliklerini sağladığını ve uygunluğunu beyan eder.

ÖZAK GEÇİŞ TEKNOLOJİLERİ SANAYİ TİC. A.Ş. hereby declare that the above listed products satisfy and comply with the requirements of Harmonised Standards for 2006/42/EC Machinery Directive and 2014/30/EU Electromagnetic Compatibility Directive.

İsim/Name : ÖZER ÖZALP Ünvan/Title : GENEL MÜDÜR/GENERAL MANAGER  
Yer ve Tarih/Place and Date : KOCAELİ / 10.03.2022 İmza/Signature

# ÖZAK



Google Map



+90 262 373 48 48

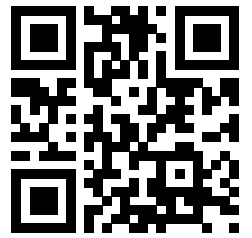

www.ozak-t.com

Çuhane Cd. N: 130 41080  
Köseköy / Kartepe / Kocaeli / TÜRKİYE

**T:** +90 262 373 48 48

**F:** +90 262 373 48 48

**E:** ozak@ozak-t.com

KK-1302-0001 R(11) 29.03.2022