

LSxxxUxx-ES/EG_LCD Video Wall

User's Manual

V1.0.1

Cybersecurity Recommendations

Mandatory actions to be taken towards cybersecurity

1. Change Passwords and Use Strong Passwords:

The number one reason systems get “hacked” is due to having weak or default passwords. It is recommended to change default passwords immediately and choose a strong password whenever possible. A strong password should be made up of at least 8 characters and a combination of special characters, numbers, and upper and lower case letters.

2. Update Firmware

As is standard procedure in the tech-industry, we recommend keeping NVR, DVR, and IP camera firmware up-to-date to ensure the system is current with the latest security patches and fixes.

“Nice to have” recommendations to improve your network security

1. Change Passwords Regularly

Regularly change the credentials to your devices to help ensure that only authorized users are able to access the system.

2. Change Default HTTP and TCP Ports:

- Change default HTTP and TCP ports for systems. These are the two ports used to communicate and to view video feeds remotely.
- These ports can be changed to any set of numbers between 1025-65535. Avoiding the default ports reduces the risk of outsiders being able to guess which ports you are using.

3. Enable HTTPS/SSL:

Set up an SSL Certificate to enable HTTPS. This will encrypt all communication between your devices and recorder.

4. Enable IP Filter:

Enabling your IP filter will prevent everyone, except those with specified IP addresses, from accessing the system.

5. Change ONVIF Password:

On older IP Camera firmware, the ONVIF password does not change when you change the system’s credentials. You will need to either update the camera’s firmware to the latest revision or manually change the ONVIF password.

6. Forward Only Ports You Need:

- Only forward the HTTP and TCP ports that you need to use. Do not forward a huge range of numbers to the device. Do not DMZ the device's IP address.
- You do not need to forward any ports for individual cameras if they are all connected to a recorder on site; just the NVR is needed.

7. Disable Auto-Login on SmartPSS:

Those using SmartPSS to view their system and on a computer that is used by multiple people should disable auto-login. This adds a layer of security to prevent users without the appropriate credentials from accessing the system.

8. Use a Different Username and Password for SmartPSS:

In the event that your social media, bank, email, etc. account is compromised, you would not want someone collecting those passwords and trying them out on your video surveillance system. Using a different username and password for your security system will make it more difficult for someone to guess their way into your system.

9. Limit Features of Guest Accounts:

If your system is set up for multiple users, ensure that each user only has rights to features and functions they need to use to perform their job.

10. UPnP:

- UPnP will automatically try to forward ports in your router or modem. Normally this would be a good thing. However, if your system automatically forwards the ports and you leave the credentials defaulted, you may end up with unwanted visitors.
- If you manually forwarded the HTTP and TCP ports in your router/modem, this feature should be turned off regardless. Disabling UPnP is recommended when the function is not used in real applications.

11. SNMP:

Disable SNMP if you are not using it. If you are using SNMP, you should do so only temporarily, for tracing and testing purposes only.

12. Multicast:

Multicast is used to share video streams between two recorders. Currently there are no known issues involving Multicast, but if you are not using this feature, deactivation can enhance your network security.

13. Check the Log:

If you suspect that someone has gained unauthorized access to your system, you can check the system log. The system log will show you which IP addresses were used to login to your system and what was accessed.

14. Physically Lock Down the Device:

Ideally, you want to prevent any unauthorized physical access to your system. The best way to achieve this is to install the recorder in a lockbox, locking server rack, or in a room that is behind a lock and key.

15. Connect IP Cameras to the PoE Ports on the Back of an NVR:

Cameras connected to the PoE ports on the back of an NVR are isolated from the outside world and cannot be accessed directly.

16. Isolate NVR and IP Camera Network

The network your NVR and IP camera resides on should not be the same network as your public computer network. This will prevent any visitors or unwanted guests from getting access to the same network the security system needs in order to function properly.

Regulatory Information

The regulatory information herein might vary according to the model you purchased. Some information is only applicable for the country or region where the product is sold.

FCC Information



Changes or modifications not expressly approved by the party responsible for compliance could void the user's authority to operate the equipment.

FCC conditions:

This device complies with part 15 of the FCC Rules. Operation is subject to the following two conditions:

- This device may not cause harmful interference.
- This device must accept any interference received, including interference that may cause undesired operation.

FCC compliance:

This equipment has been tested and found to comply with the limits for a digital device, pursuant to part 15 of the FCC Rules. This equipment generate, uses and can radiate radio frequency energy and, if not installed and used in accordance with the guide, may cause harmful interference to radio communication.





- For class A device, these limits are designed to provide reasonable protection against harmful interference in a commercial environment. Operation of this equipment in a residential area is likely to cause harmful interference in which case the user will be required to correct the interference at his own expense.
- For class B device, these limits are designed to provide reasonable protection against harmful interference in a residential installation. However, there is no guarantee that interference will not occur in a particular installation. If this equipment does cause harmful interference to radio or television reception, which can be determined by turning the equipment off and on, the user is encouraged to try to correct the interference by one or more of the following measures:
 - Reorient or relocate the receiving antenna.
 - Increase the separation between the equipment and receiver.
 - Connect the equipment into an outlet on a circuit different from that to which the receiver is connected.
 - Consult the dealer or an experienced radio/TV technician for help.

Overview

This User's Manual (hereinafter referred to as the "Manual") is about the operation and maintenance of the LCD Video Wall (hereinafter referred to as "video wall").

Safety Instructions

The following categorized signal words with defined meaning might appear in the Manual.

Signal Words	Meaning
 DANGER	Indicates a high potential hazard which, if not avoided, will result in death or serious injury.
 WARNING	Indicates a medium or low potential hazard which, if not avoided, could result in slight or moderate injury.
 CAUTION	Indicates a potential risk which, if not avoided, could result in property damage, data loss, lower performance, or unpredictable result.
 TIPS	Provides methods to help you solve a problem or save you time.
 NOTE	Provides additional information as the emphasis and supplement to the text.

Revision History

No.	Version	Revision Content	Release Time
1	V1.0.0	First Release.	August 22, 2018

Privacy Protection Notice

As the device user or data controller, you might collect personal data of other such as face, fingerprints, car plate number, Email address, phone number, GPS and so on. You need to be in compliance with the local privacy protection laws and regulations to protect the legitimate rights and interests of other people by implementing measures include but not limited to: providing clear and visible identification to inform data subject the existence of surveillance area and providing related contact.

About the Manual

- The Manual is for reference only. If there is inconsistency between the Manual and the actual product, the actual product shall prevail.
- We are not liable for any loss caused by the operations that do not comply with the Manual.
- The Manual would be updated according to the latest laws and regulations of related regions. For detailed information, see the paper manual, CD-ROM, QR code or our official website. If there is inconsistency between paper manual and the electronic version, the electronic version shall prevail.
- All the designs and software are subject to change without prior written notice. The product updates might cause some differences between the actual product and the Manual. Please contact the customer service for the latest program and supplementary documentation.
- There still might be deviation in technical data, functions and operations description, or errors in print. If there is any doubt or dispute, please refer to our final explanation.
- Upgrade the reader software or try other mainstream reader software if the Manual (in PDF format) cannot be opened.
- All trademarks, registered trademarks and the company names in the Manual are the properties of their respective owners.
- Please visit our website, contact the supplier or customer service if there is any problem occurred when using the device.
- If there is any uncertainty or controversy, please refer to our final explanation.

Table of Contents

Cybersecurity Recommendations	2
Regulatory Information	4
Foreword	5
1 Maintenance	8
1.1 Environmental Requirement.....	8
1.2 Maintenance Tips.....	8
2 Unpacking the Box	11
3 Introduction	12
3.1 LCD Video Wall.....	12
3.2 Port.....	12
3.3 Remote Control.....	14
4 Interface Configuration	16
4.1 Picture.....	17
4.1.1 Picture Mode.....	17
4.1.2 Contrast.....	17
4.1.3 Brightness.....	18
4.1.4 Saturability.....	18
4.1.5 Sharpness.....	19
4.1.6 Color Temperature.....	19
4.1.7 Aspect Ratio.....	19
4.1.8 Noise Reduction.....	20
4.1.9 Hue.....	20
4.2 Geometry.....	20
4.2.1 DVI/HDMI/CVBS Signal.....	21
4.2.2 VGA Signal.....	21
4.3 Advanced.....	22
4.4 Option.....	22
4.4.1 OSD Language.....	22
4.4.2 OSD Duration.....	23
4.4.3 Blending.....	23
4.4.4 Backlight Mode.....	23
4.4.5 Soft Addr.....	24
4.4.6 Restore Settings.....	24
4.4.7 Version Info.....	24
4.5 Source.....	25
5 FAQ	27

1.1 Environmental Requirement

- The video wall can only be installed indoors. It is recommended that the room where the video wall is installed be equipped with air conditioner. The video wall cannot be operated in environment with high humidity and heavy dust.
- Do not block the vent of the video wall and the airflow around it; otherwise the temperature of the video wall will increase, and fire might occur.

1.2 Maintenance Tips

Comply with the maintenance rule strictly to prolong the life span of the video wall and to implement energy conservation and emission reduction.

Operating Time

Because of high temperature, electronic products will age rapidly if they are operated for a long time. The relation of operating time and performance of the video wall is as follows. See Figure 1-1.

Figure 1-1 Performance

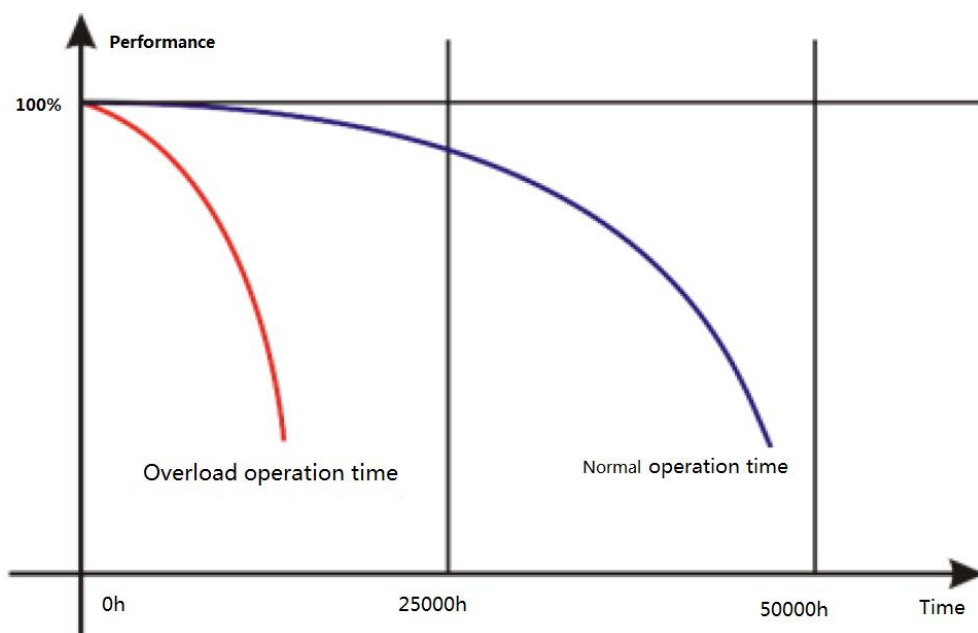

To prolong the life span of the video wall and save maintenance expenses, follow the suggestions bellow.

- If the video wall has worked for ten hours, turn it off and then turn it on after 15–30 minutes.
- If the video wall has worked for 7×24 hours, turn it off and then turn it on after two hours.

Temperature, Humidity and Ventilation

- The appropriate ambient temperature range for the video wall is $22^{\circ}\text{C}\pm 4^{\circ}\text{C}$, and the appropriate relative humidity range is 30%–70%, no condensation. There must be no great temperature and humidity difference.
- If the video wall is used in environment with high temperature and humidity, there will be tiny water drops on the surface and frame of the video wall. The water drops will flow inside the video wall. As a result, the glass structure will be damaged, and the liquid crystal molecule aggregation and outflow will occur. The phenomenon is displayed in Figure 1-2.

Figure 1-2 Liquid crystal leakage



During the operation, pay attention to the bellow points.

- Before turning off the video wall, make sure that the temperatures of the air conditioners in the server room and the room where the video wall is installed are the same.
- If the video wall has been off for a long time, check if there are water drops on the surface. If there are water drops, do not dry the surface with wet cloth. Dry the surface with absorbent paper, do not plug it in, and contact the after-sales personnel.



Free quality assurance service is not applicable to damage (includes but not limited to the damage to the video wall and damage to the user or the third party) results from incorrect using and maintaining the video wall.

Cleaning

- Use degreasing cotton or cloth to clean the screen.
- The ideal detergent is isopropanol or n-hexane. Do not use ketone (like acetone) to clean the screen.
- Before you clean the screen, pull the plug out of the socket.
- Wet cloth is not allowed to clean the video wall because there will be tiny water drops on the surface and frame of the video wall. The water drops will flow inside the video wall. As a result, the glass structure will be damaged, and the liquid crystal molecule aggregation and outflow will occur.
- The panel is fragile. As a result, you must not press or scratch the surface of the screen with great force.

Power Supply

Stable 100V–240V single phase power supply is needed; otherwise the video wall cannot work normally. To get stable voltage and prevent damage result from electrical surge, use the stabilized voltage supply.

Storage Requirement

- If the video wall will not be used for a long time, cover it with the dust-cloth.
- If the video wall has not been used for over six months before you start to use it again, do dust removal first, or contact professional company to do the maintenance.



If the video wall is not in use for a long time, it will gather dust and heat radiation will be influenced.

Dust-Proof Requirement

During debugging and operation, the dust concentration of the working area should not exceed 10mg/m³.

If the video wall must be used in environment with high temperature and high humidity, or the video wall must be in single display mode for a long time, we strongly recommend you to contact engineers of our company to get suggestions. Otherwise the reliability and performance could be greatly influenced.



Places like airports, banks and stock markets are places with great dust and temperature difference and humidity difference.

2

Unpacking the Box

Check against Table 2-1 to see if the components are complete.



The actual appearance, items, or quantity might be different depending on the mode you purchased, and the actual packing list shall prevail.

Table 2-1 Packing list

Component	Quantity
Liquid crystal video wall	1
AC Power cable	1
Network cable	1
Remote control	1
Battery	1pair

3.1 LCD Video Wall

The LCD video wall is displayed in Figure 3-1.

Figure 3-1 LCD video wall

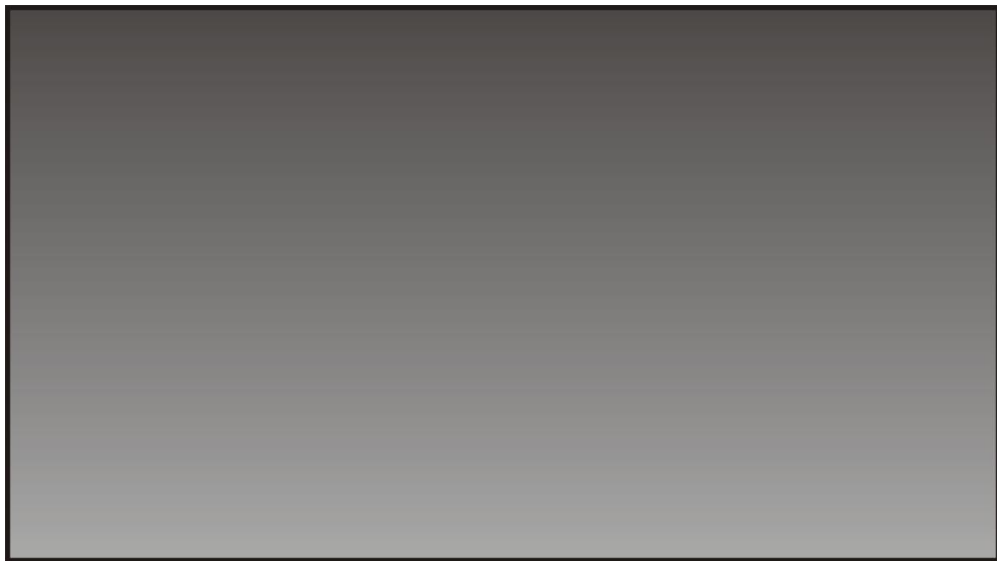

3.2 Port

Ports are displayed in Figure 3-2. For detailed parameters, see Table 3-1.

Figure 3-2 Port

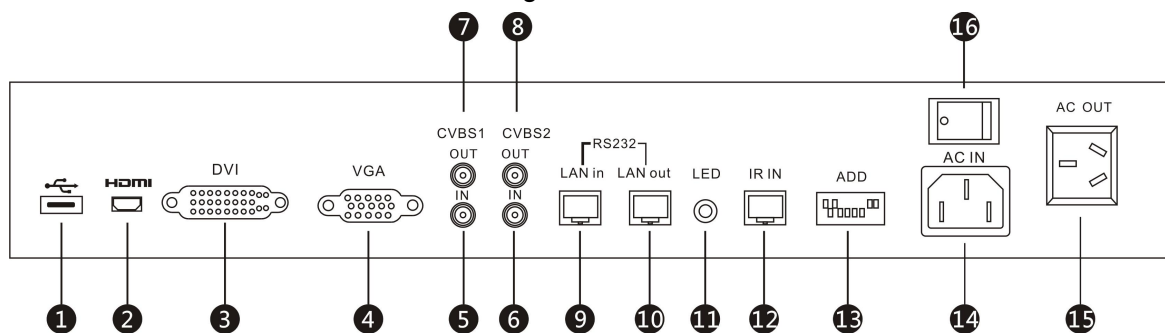

Table 3-1 Port description

No.	Port	Function
1	USB2.0 port	For multimedia playing and upgrade.
2	HDMI in	Inputs HDMI signals. Compatible with 1920×1080/60Hz or lower.
3	DVI in	Inputs DVI signals. Compatible with 1920×1080/60Hz or lower.

No.	Port	Function
4	VGA in	Inputs VGA signals. Compatible with 1920×1080/60Hz or lower.
5	CVBS1 in	Inputs CVBS1 signals. Compatible with 1920×1080/60Hz or lower.
6	CVBS2 in	Inputs CVBS2 signals. Compatible with 1920×1080/60Hz or lower.
7	CVBS1 out	Outputs CVBS1 signals. Compatible with 1920×1080/60Hz or lower.
8	CVBS2 out	Outputs CVBS2 signals. Compatible with 1920×1080/60Hz or lower.
9	LAN in	An RJ-45 port, inputs RS-232 signals. It controls the screen.
10	LAN out	An RJ-45 port, outputs RS-232 signals.
11	LED	LED indication light
12	IR in	Connected to the IR extension cable.
13	ADD	Address dial switch.For expanded use
14	Power input	Inputs AC current.
15	Power output	Outputs AC current.
16	Power switch	Controls the on and off of the AC input port.

3.3 Remote Control

Remote control is a must-have device. For functions of its buttons, see Table 3-2.

Table 3-2 Button functions

Picture	No.	Name	Function
	1	Power	Power on/Standby
	2	Address	Shortcut keyboard for address setting (dedicated to monitors).
	3	Signal source	Shortcut keyboard for signal source selection. <ul style="list-style-type: none"> • TV1: switch signals to CVBS1 signal. • TV2: switch signals to CVBS2 signal. • VGA: switch signals to VGA signal. • HDMI: switch signals to HDMI signal. • DVI: switch signals to DVI signal.
	4	FRZ	Pause button, used to stop playing videos.
	5	Signal format	Shortcut keyboard for displaying the current input signals.
	6	Version info	Shortcut keyboard for displaying version of the system.
	7	Menu	Press Menu to display or exit the menu interface. Press Menu to confirm the operation you have done.
	8	Direction button	Left and right direction button: Use it to select items on the left or right of the current parameter on the screen (if you have selected voice, you can use these buttons to adjust the volume).

Picture	No.	Name	Function
			Up and down direction button: Use it to select items up or below the current item you have selected on the screen.
	9	Picture mode	Shortcut keyboard for Picture mode selection.
	10	Brightness	Shortcut keyboard for brightness mode selection.
	11	Number buttons	Press number buttons to enter numbers.
	12	Enter	Press Enter to confirm and enter the multimedia interface.
	13	Return	Press Return to exit the multimedia interface.

4 Interface Configuration







Use the remote control to configure parameters for the video wall. Press the menu button, the menu of the video wall is displayed in Figure 4-1.

Figure 4-1 Menu



For introductions of icons on the interface, see Table 4-1.

Table 4-1 Icon description

Icon	Description
	Picture icon, used to set display effect for the picture.
	Geometry icon, used to set positions for picture.
	Advance icon, used to do advanced settings to picture.  Advanced options must be set by professional personnel.
	Option icon, used to configure parameters for the system.
	Source icon, used to select signal mode.



- Press **Menu** on the remote control, the menu bar is displayed on the video wall, and then you can adjust relevant parameters.
- Press **down** on the remote control to exit the current menu.

4.1 Picture

Press **Menu** on the remote control, the menu interface is displayed on the video wall. The default menu bar is **Picture** menu bar. See Figure 4-2.

Figure 4-2 Picture

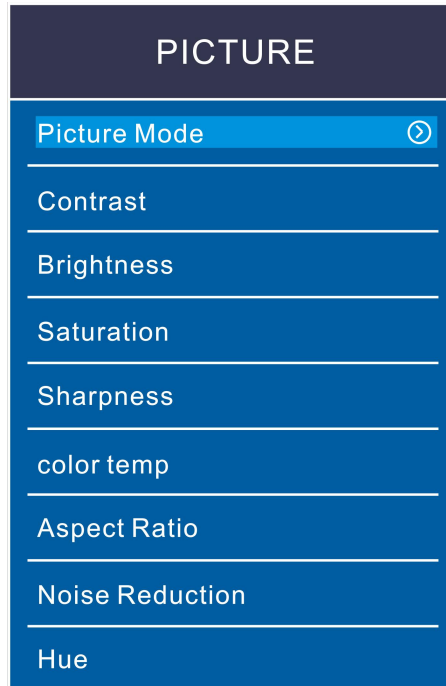

4.1.1 Picture Mode

You can adjust the overall effects of picture through **Picture Mode**.

Step 1 Select **Picture > Contrast**.

The **Picture Mode** interface is displayed. See Figure 4-3.

Figure 4-3 Picture Mode



Step 1 Adjust the picture mode by the up and down buttons on the remote control according to your requirement.



- There are four picture modes: User Mode, Dynamic, Standard, Mild and User.

4.1.2 Contrast

You can adjust the luminance or color of Pictures to make objects in Pictures distinguishable by adjusting **Contrast**.

Step 2 Select **Picture > Contrast**.

The **Contrast** interface is displayed. See Figure 4-4.

Figure 4-4 Contrast

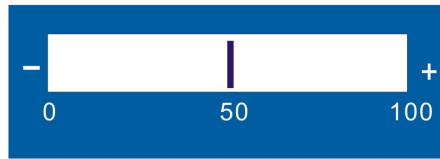

Step 3 Adjust the Contrast by the left and right buttons on the remote control according to your requirement.



The range of contrast is 0–100.

4.1.3 Brightness

You can adjust the brightness of Pictures.

Step 4 Select **Picture > Brightness**.

The **Brightness** interface is displayed. See Figure 4-5.

Figure 4-5 Brightness

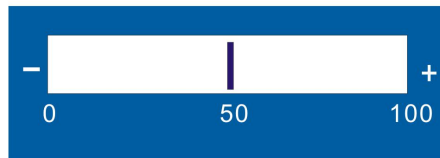

Step 5 Adjust the brightness by the left and right buttons on the remote control according to your requirement.



The range of brightness is 0–100.

4.1.4 Saturability

You can adjust lightness and darkness of pictures by adjusting sautrability.

Step 1 Select **Picture>Saturability**.

The **Saturability** interface is displayed. See Figure 4-6.

Figure 4-6 Saturability

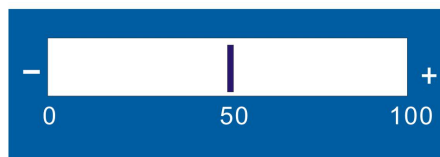

Step 2 Adjust the Saturability by the left and right buttons on the remote control according to your requirement.



The range of saturability is 0–100.

4.1.5 Sharpness

Definition of pictures can be adjusted by adjusting sharpness. The higher the sharpness is, the clearer the pictures are, and picture noise might occur.

Step 1 Select **Picture > Sharpness**.

The **Sharpness** interface is displayed. See Figure 4-7.

Figure 4-7 Sharpness

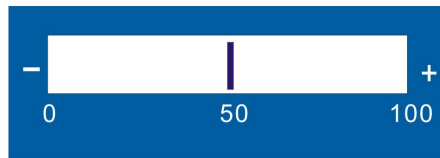

Step 2 Adjust the sharpness by the left and right buttons on the remote control according to your requirement.



The range of sharpness is 0–100.

4.1.6 Color Temperature

You can adjust color temperature of pictures.

Step 1 Select **Picture > Color Temperature**.

The **Color Temperature** interface is displayed. See Figure 4-8.

Figure 4-8 Color temperature

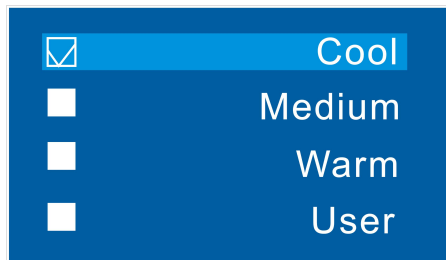

Step 2 Adjust color temperature by the up and down buttons on the remote control according to your requirement.



- Color temperature has four types: cool, medium, warm, and user.

4.1.7 Aspect Ratio

Display scales can be adjusted by adjusting aspect ratio.

Step 1 Select **Picture > Aspect Ratio**.

The **Aspect Ratio** interface is displayed. See Figure 4-9.

Figure 4-9 Aspect ratio

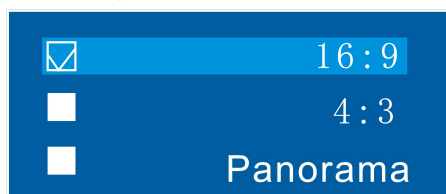

Step 2 Select **Aspect Ratio** by the up and down buttons on the remote control according to your requirement. For parameters of zoom mode, see Table 4-2.

Table 4-2 Parameters of zoom mode

Parameter	Descriptions
4:3	Pictures are displayed on the scale of 4:3.
16:9	Pictures are displayed on the scale of 16:9.
Panorama	Display in full screen.

4.1.8 Noise Reduction

To improve quality of pictures, adjust the noise reduction.



Only in CVBS signal mode can you select picture noise deduction function.

Step 1 Select **Picture > Noise Reduction**.

The **Noise Reduction** interface is displayed. See Figure 4-10.

Figure 4-10 Noise reduction

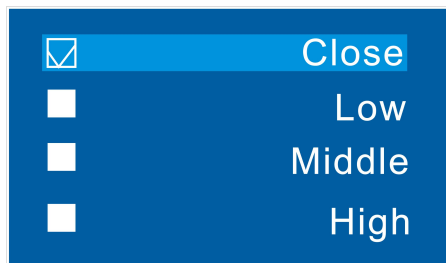

Step 2 Select noise reduction parameters by the up and down buttons on the remote control according to your requirement.

4.1.9 Hue

It is used to adjust the tone of a screen.



Only valid under NTSC standard.

Step 1 Select **Picture > Hue**

The **HUe** interface is displayed. See Figure 4-811

Figure 4-11 Hue

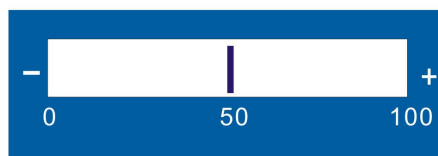

Step 2 Adjust Hue by the left and right on the remote control according to your requirement.

4.2 Geometry

Different signal modes have different geometry parameters.

4.2.1 DVI/HDMI/CVBS Signal

On the main menu, press the left and right direction buttons until the **Geometry** interface is displayed. See Figure 4-13.

Figure 4-12 Geometry (DVI/HDMI/AV)

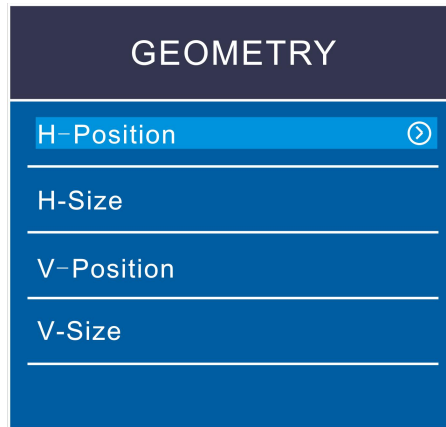

H-Position is used to adjust the horizontal position of the video wall.

H-Size is used to adjust the horizontal size of the video wall.

V-Position is used to adjust the vertical position of the video wall.

V-Size is used to adjust the vertical size of the video wall.

4.2.2 VGA Signal

On the main menu, press the left and right direction buttons until the **Geometry** interface is displayed. See Figure 4-13.

Figure 4-13 Geometry (VGA)

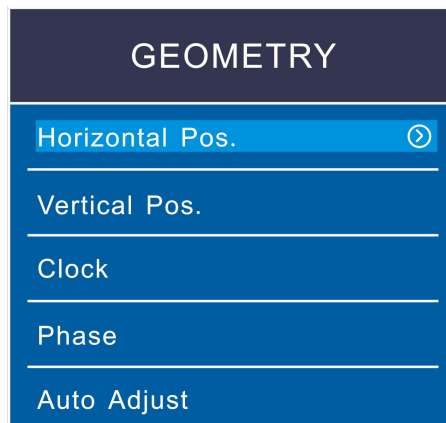

Horizontal Pos. is used to adjust the horizontal position of the video wall.

Vertical Pos. is used to adjust the vertical position of the video wall.

Clock is used to adjust the horizontal picture proportion

Phase is used to adjust the position of a point in time on a waveform cycle.

Auto Adjust: The position of video wall can be automatically adjusted.

4.3 Advanced



If you are not professional personnel, do not change parameters in the Advanced menu.

You can select **Advanced** by the up and down buttons on the remote control.

4.4 Option

On the main menu, press the left and right direction buttons until the **Option** displayed.

Figure 4-14 OPTION

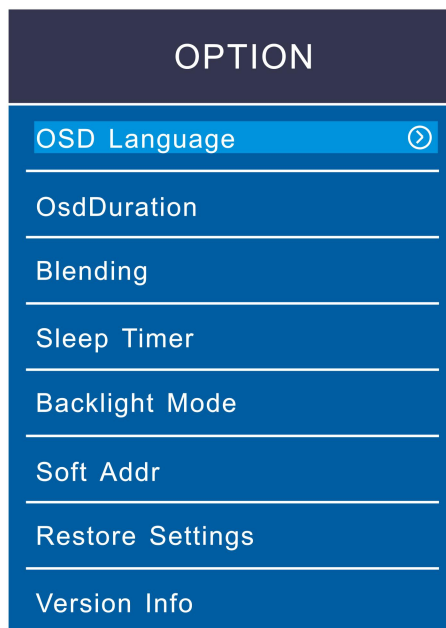

4.4.1 OSD Language

You can set on-screen display language.

Step 1 Select **System>OSD Language**.

The **OSD Language** interface is displayed. See Figure 4-15.

Figure 4-15 OSD language



Step 2 Select the OSD language by the up and down buttons.



OSD language includes English and Chinese.

4.4.2 OSD Duration

OSD duration is the time displayed on the screen.

Step 1 Select **System>OSD Duration**.

The **OSD Duration** interface is displayed. See Figure 4-16.

Figure 4-16 OSD duration



Step 2 Set OSD duration by the up and down buttons on the remote control according to your requirement.



- There are four choices for the OSD duration: OFF, 30s, 60s, and 180s.
- If you select OFF, the menu will not disappear automatically.

4.4.3 Blending

OSD blending is used to set the transparency for the menu.

Step 1 Select **System>Blending**.

The **Blending** interface is displayed. See Figure 4-17.

Figure 4-17 OSD Blending

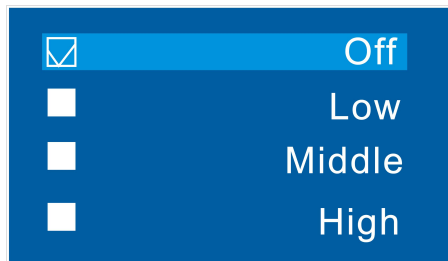

Step 2 Adjust the menu transparency by the up and down buttons on the remote control according to your requirement.

4.4.4 Backlight Mode

Backlight mode is used to set the backlight luminance for screens.

Step 1 Select **System>Backlight Mode**.

The **Backlight Mode** interface is displayed. See Figure 4-18.

Figure 4-18 Backlight mode

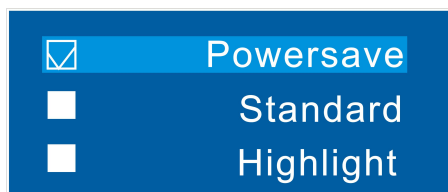

Step 2 Adjust backlight mode by the up and down buttons on the remote control according to your requirement.



There are three backlight modes: Powersave, Standard, Highlight.

4.4.5 Soft Addr

Soft addr switch is used to set soft address switch.

Step 1 Select **System>Soft Addr**.

The **Soft Addr** interface is displayed. See Figure 4-19.

Figure 4-19 Soft address switch

Soft Addr	On
Row Addr	1
Line Addr	1
Row Range	1
Line Range	1
Unit Display	Off

Step 2 Set soft address by the left and right buttons on the remote control according to your requirement. For detailed parameters, see Table 4-3.

Table 4-3 Soft address parameters.

Parameter	Descriptions
Row address	Row address of the screen.
Line address	Line address of the screen.
Row range	Row range of the screen.
Line range	Line range of the screen.
Unit display	There are two options: On and Off.



Here line means column.

4.4.6 Restore Settings

Restore settings is used to restore the system to factory settings.

Step 1 Select **System>Restore Setting**.

Step 2 Press **right** buttons of the remote control to complete the setting.

4.4.7 Version Info

Version is used to display program version

Step 1 Select **System>Version Info**.

Step 2 Press **right** buttons of the remote control to display program version.

4.5 Source

You can select the types of input signal for video walls.

Step 1 On the main menu, press the left and right direction buttons until the **Source** interface is displayed. See Figure 4-20.

Figure 4-20 source



Step 2 Select input signal types by the up and down buttons.

- VGA, HDMI, DVI, AV1 and AV2.
- Press **right** button to select the needed input signal type.



Here AV means CVBS.

- **USB**

1) Press **Menu**, and the multimedia play setting interface is displayed. See Figure 4-21.

Figure 4-21 Multimedia (1)

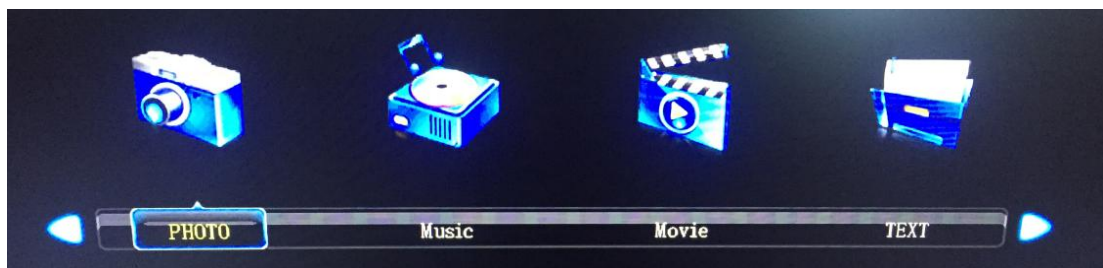

2) Select photo, music, movie, and text by the left and right buttons on the remote control, and then press **Enter**, the interface of items you selected is displayed. See Figure 4-22.

Figure 4-22 Multimedia (2)

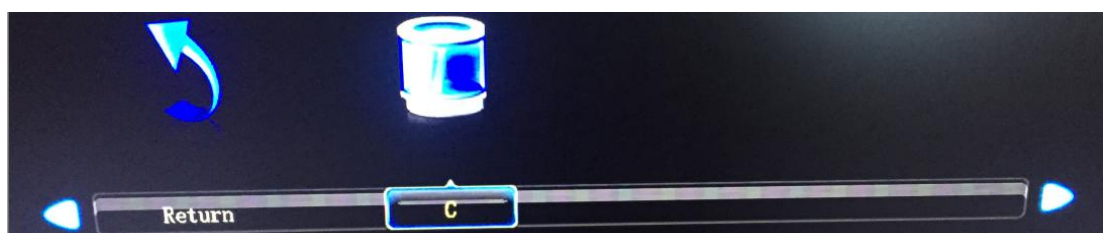

3) You can also change settings for the pictures, music, movies, and files that are to be played. See Figure 4-23.

Figure 4-23 Multimedia (3)

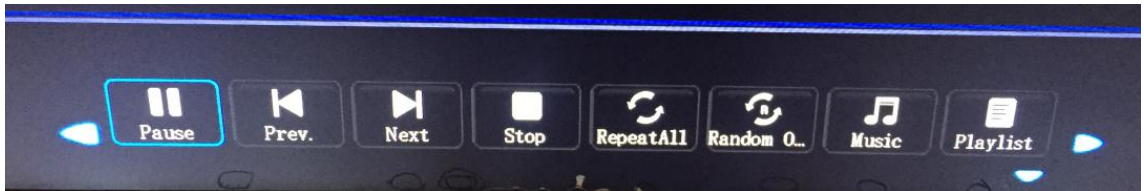

Most problems can be solved by the following solutions. If problems you encountered do not belong to the following descriptions, contact after sales personnel.

Problems	Solutions
When you turn on the LCD video wall, there are no pictures on the screen (blank screen).	<ul style="list-style-type: none"> ● Check whether the power source (220V AC) is connected to alternating current. ● Check whether the power cable is broken. ● Check whether the power switch is on. ● Check whether the power switch is broken. ● Check whether the indicator light is on.
Blank screen (no signal displayed)	<ul style="list-style-type: none"> ● Check whether the signal wires are in bad contact. ● Check whether there is signal source output. ● Check whether the signal wires are broken. ● Check whether the input signal type does not belong to the types allowed by the video wall.
Color missing	<ul style="list-style-type: none"> ● Check whether the signal wires are in bad contact. ● Check whether the signal wires are broken.
Remote control cannot control the screen.	<ul style="list-style-type: none"> ● Check whether buttons on the remote control is broken or stuck. ● Check whether batteries of the remote control are installed correctly.
Temperature of the video wall is too high.	Check whether the ventilation around the video wall is good.