



AI Digital Video Recorder

User's Manual







Foreword

General

This user's manual (hereinafter referred to be "the Manual") introduces the functions and operations of the DVR devices (hereinafter referred to as "the Device"). Read carefully before using the device, and keep the manual safe for future reference.

Safety Instructions

The following signal words might appear in the manual.

Signal Words	Meaning
 DANGER	Indicates a high potential hazard which, if not avoided, will result in death or serious injury.
 WARNING	Indicates a medium or low potential hazard which, if not avoided, could result in slight or moderate injury.
 CAUTION	Indicates a potential risk which, if not avoided, could result in property damage, data loss, lower performance, or unpredictable result.
 TIPS	Provides methods to help you solve a problem or save you time.
 NOTE	Provides additional information as the emphasis and supplement to the text.

Revision History

Version	Revision Content	Release Time
V2.0.0	<ul style="list-style-type: none"> ● Added DH-XVR42xxAN-I(V2.0). ● Added smart illumination as alarm linkage. ● Added schedule mode for AI functions. ● Added IVS mode switch. ● Added disabling event notifications in disarming. ● Added sensitivity for IVS settings. ● Updated disk quota. ● Supports safety baseline 2.0. 	April 2022
V1.2.1	<ul style="list-style-type: none"> ● Updated AI mode switch. ● Added intelligent diagnosis. ● Updated alarm-in port settings. ● Updated password resetting. 	December 2021

Version	Revision Content	Release Time
V1.2.0	Added some models.	October 2021
V1.1.0	Added DH-XVR4232AN-I.	July 2021
V1.0.11	Added DH-XVR5816S-4KL-I2-LP and DH-XVR7816S-4KL-X-LP-V2.	May 2021
V1.0.10	Deleted the video quality analytics function.	April 2021
V1.0.9	Added some models.	February 2021
V1.0.8	Added some models.	November 2020
V1.0.7	Added some models.	September 2020
V1.0.6	Added some models.	May 2020
V1.0.5	Updated to 4.0 UI version.	February 2020
V1.0.4	Added disarm function, HDD database function, and SMD preview function. Optimizes Smart Search function, available to filtering human and vehicle.	September 2019
V1.0.0	First release.	October 2018

Privacy Protection Notice

As the device user or data controller, you might collect the personal data of others such as their face, fingerprints, and license plate number. You need to be in compliance with your local privacy protection laws and regulations to protect the legitimate rights and interests of other people by implementing measures which include but are not limited: Providing clear and visible identification to inform people of the existence of the surveillance area and provide required contact information.

About the Manual

- The manual is for reference only. Slight differences might be found between the manual and the product.
- We are not liable for losses incurred due to operating the product in ways that are not in compliance with the manual.
- The manual will be updated according to the latest laws and regulations of related jurisdictions. For detailed information, see the paper user's manual, use our CD-ROM, scan the QR code or visit our official website. The manual is for reference only. Slight differences might be found between the electronic version and the paper version.
- All designs and software are subject to change without prior written notice. Product updates might result in some differences appearing between the actual product and the manual. Please contact customer service for the latest program and supplementary documentation.

- There might be errors in the print or deviations in the description of the functions, operations and technical data. If there is any doubt or dispute, we reserve the right of final explanation.
- Upgrade the reader software or try other mainstream reader software if the manual (in PDF format) cannot be opened.
- All trademarks, registered trademarks and company names in the manual are properties of their respective owners.
- Please visit our website, contact the supplier or customer service if any problems occur while using the device.
- If there is any uncertainty or controversy, we reserve the right of final explanation.

Important Safeguards and Warnings

This chapter describes the contents covering proper handling of the Device, hazard prevention, and prevention of property damage. Read carefully before using the device, and comply with the guidelines when using it.

Operation Requirements

- Do not place or install the Device in a place exposed to sunlight or near the heat source.
- Keep the Device away from dampness, dust or soot.
- Keep the Device installed horizontally on the stable place to prevent it from falling.
- Wall-mounting is not supported.
- Do not drop or splash liquid onto the Device, and make sure there is no object filled with liquid on the Device to prevent liquid from flowing into the Device.
- Install the Device in a well-ventilated place, and do not block the ventilation of the Device.
- Operate the device within the rated range of power input and output.
- Do not disassemble the Device.
- Transport, use and store the Device under the allowed humidity and temperature conditions.

Electrical Safety

- Use the battery of specified manufacturer; otherwise there might result in explosion. When replacing battery, make sure the same type is used. Improper battery use might result in fire, explosion, or inflammation.
- Follow the instructions to dispose of the used battery.
- Use the recommended power cables in the region and conform to the rated power specification.
- Use the power adapter provided with the Device, or adapter meets the LPS standard; otherwise, it might result in people injury and device damage.
- The power supply must conform to the requirements of ES1 in IEC 62368-1 standard and be no higher than PS2. Note that the power supply requirements are subject to the device label.
- Connect the device (I-type structure) to the power socket with protective earthing.
- The appliance coupler is a disconnection device. When using the coupler, keep the angle for easy operation.

Table of Contents

Foreword.....	II
Important Safeguards and Warnings.....	V
1 Introduction.....	1
1.1 Overview	1
1.2 Functions.....	1
2 Getting Started	3
2.1 Checking the Components	3
2.2 Installing HDD	3
2.2.1 DH-XVR42xxAN-I/DH-XVR42xxAN-I(V2.0)/DH-XVR52xxA-I2/DH-XVR52xxA-I3/DH-XVR52xxA-4KL-I2/DH-XVR52xxA-4KL-I3/DH-XVR52xxAN-I2/DH-XVR52xxAN-I3/DH-XVR52xxAN-4KL-I2/DH-XVR52xxAN-4KL-I3/DH-XVR72xxA-4K-I2/DH-XVR72xxA-4KL-I/DH-XVR7216AN-4K-I2/DH-XVR82xxA-4K-I/DH-XVR82xxA-4KL-I.....	4
2.2.2 DH-XVR58xxS-I2/DH-XVR58xxS-4KL-I2/DH-XVR58xxS-4KL-I2-LP/DH-XVR78xxS-4K-I2/DH-XVR78xxS-4KL-X-LP-V2/DH-XVR88xxS-4KL-I/.....	6
2.2.3 DH-XVR54xxL-I2/DH-XVR54xxL-4KL-I2/DH-XVR74xxL-4K-I2.....	8
2.2.4 DH-XVR1Bxx-I/DH-XVR1BxxH-I/DH-XVR41xxC-I/DH-XVR41xxHS-I/DH-XVR51xxH-I/DH-XVR51xxH-I2/DH-XVR51xxH-I3/DH-XVR51xxH-4KL-I2/DH-XVR51xxH-4KL-I3/DH-XVR51xxHE-I2/DH-XVR51xxHE-I3/DH-XVR51xxHE-4KL-I2/DH-XVR51xxHE-4KL-I3/DH-XVR51xxHS-I2/DH-XVR51xxHS-I3/DH-XVR51xxHS-4KL-I2/DH-XVR51xxHS-4KL-I3/DH-XVR71xxH-4K-I2/DH-XVR71xxHE-4KL-I/DH-XVR71xxHE-4K-I2	10
2.2.5 DH-XVR51xxC-I3/DH-XVR51xxC-4KL-I3	12
3 The Grand Tour	15
3.1 Front Panel.....	15
3.1.1 DH-XVR51xxH-I.....	15
3.1.2 DH-XVR71xxH-4K-I2/DH-XVR71xxHE-4K-I2/DH-XVR71xxHE-4KL-I.....	15
3.1.3 DH-XVR72xxA-4KL-I/DH-XVR72xxAN-4K-I2.....	16
3.1.4 DH-XVR82xxA-4K-I/DH-XVR82xxA-4KL-I	16
3.1.5 DH-XVR41xxC-I/DH-XVR41xxHS-I/DH-XVR42xxAN-I/DH-XVR42xxAN-I(V2.0)/DH-XVR51xxH-I2/DH-XVR51xxH-I3/DH-XVR51xxH-4KL-I2/DH-XVR51xxH-4KL-I3/DH-XVR51xxHE-I2/DH-XVR51xxHE-I3/DH-XVR51xxHE-4KL-I2/DH-XVR51xxHE-4KL-I3/DH-XVR51xxHS-I2/DH-XVR51xxHS-I3/DH-XVR51xxHS-4KL-I2/DH-XVR51xxHS-4KL-I3/DH-XVR52xxA-I2/DH-XVR52xxA-I3/DH-XVR52xxA-4KL-I2/DH-XVR52xxA-4KL-I3/DH-XVR52xxAN-I2/DH-XVR52xxAN-I3/DH-XVR52xxAN-4KL-I2/DH-XVR52xxAN-4KL-I3	17
3.1.6 DH-XVR78xxS-4K-I2/DH-XVR78xxS-4KL-X-LP-V2/DH-XVR88xxS-4KL-I.....	18
3.1.7 DH-XVR74xxL-4K-I2	18
3.1.8 DH-XVR54xxL-I2/DH-XVR54xxL-4KL-I2.....	19
3.1.9 DH-XVR58xxS-I2/DH-XVR58xxS-4KL-I2/DH-XVR58xxS-4KL-I2-LP	19
3.1.10 DH-XVR1Bxx-I/DH-XVR1BxxH-I.....	19
3.1.11 DH-XVR51xxC-I3/DH-XVR51xxC-4KL-I3.....	20
3.2 Rear Panel	21

3.2.1	DH-XVR51xxH-I/DH-XVR51xxH-I2/DH-XVR51xxH-I3/DH-XVR51xxH-4KL-I2/DH-XVR51xxH-4KL-I3/DH-XVR51xxHE-I2/DH-XVR51xxHE-I3/DH-XVR51xxHE-4KL-I2/DH-XVR51xxHE-4KL-I3/DH-XVR71xxH-4K-I2/DH-XVR71xxHE-4K-I2/DH-XVR71xxHE-4KL-I.....	21
3.2.2	DH-XVR41xxC-I/DH-XVR41xxHS-I/DH-XVR51xxHS-I2/DH-XVR51xxHS-I3/DH-XVR51xxHS-4KL-I2/DH-XVR51xxHS-4KL-I3.....	22
3.2.3	DH-XVR52xxA-I2/DH-XVR52xxA-I3/DH-XVR52xxA-4KL-I2/DH-XVR52xxA-4KL-I3/DH-XVR42xxAN-I/DH-XVR42xxAN-I(V2.0)/DH-XVR52xxAN-I2/DH-XVR52xxAN-I3/DH-XVR52xxAN-4KL-I2/DH-XVR52xxAN-4KL-I3/DH-XVR72xxA-4K-I2/DH-XVR72xxA-4KL-I/DH-XVR72xxAN-4K-I2.....	23
3.2.4	DH-XVR82xxA-4K-I/DH-XVR82xxA-4KL-I.....	24
3.2.5	DH-XVR58xxS-I2/DH-XVR58xxS-4KL-I2/DH-XVR78xxS-4K-I2/DH-XVR88xxS-4KL-I.....	26
3.2.6	DH-XVR58xxS-4KL-I2-LP/DH-XVR78xxS-4KL-X-LP-V2.....	28
3.2.7	DH-XVR54xxL-I2/DH-XVR54xxL-4KL-I2/DH-XVR74xxL-4K-I2.....	29
3.2.8	DH-XVR1Bxx-I/DH-XVR1BxxH-I.....	31
3.2.9	DH-XVR51xxC-I3/DH-XVR51xxC-4KL-I3.....	32
3.3	Remote Control Operations.....	32
3.4	Mouse Operations.....	34
4	Connection.....	36
4.1	Typical Connection Diagram.....	36
4.2	Connecting to Video and Audio Input and Output.....	36
4.2.1	Video Input.....	36
4.2.2	Video Output.....	37
4.2.3	Audio Input.....	37
4.2.4	Audio Output.....	37
4.3	Connecting to Alarm Input and Output.....	38
4.3.1	Introducing Alarm Port.....	38
4.3.2	Alarm Input.....	39
4.3.3	Alarm Output.....	39
4.3.4	Alarm Output Relay Parameters.....	39
5	Local Configurations.....	41
5.1	Initial Settings.....	41
5.1.1	Booting up.....	41
5.1.2	Initializing the Device.....	41
5.1.3	Resetting Password.....	45
5.1.4	Setting Up with the Startup Wizard.....	52
5.2	Live View.....	69
5.2.1	Live View Screen.....	69
5.2.2	Live View Control bar.....	70
5.2.3	Navigation Bar.....	74
5.2.4	Shortcut Menu.....	75
5.2.5	AI Preview Mode.....	76
5.2.6	Channel Sequence.....	78
5.2.7	Color Setting.....	80
5.2.8	Live View Display.....	82
5.2.9	Configuring Tour Settings.....	85
5.2.10	Quick Operation Bar.....	88

5.3 Entering Main Menu	90
5.4 Controlling PTZ Cameras.....	92
5.4.1 Configuring PTZ Connection Settings	92
5.4.2 Working with PTZ Control Panel	93
5.4.3 Configuring PTZ Functions	95
5.4.4 Calling PTZ Functions.....	98
5.4.5 Calling OSD Menu.....	99
5.5 Configuring Camera Settings	100
5.5.1 Configuring Image Settings.....	100
5.5.2 Configuring Encode Settings	103
5.5.3 Configuring Snapshot Settings	105
5.5.4 Configuring Encode Enhancement.....	107
5.5.5 Configuring Overlay Settings.....	107
5.5.6 Configuring Covered Area Settings	108
5.5.7 Configuring Channel Type.....	109
5.5.8 Upgrading Coaxial Camera	110
5.6 Configuring Remote Devices.....	111
5.6.1 Adding Remote Devices.....	111
5.6.2 Managing Remote Devices	123
5.7 Configuring Record Settings.....	125
5.7.1 Enabling Record Control	126
5.7.2 Configuring Recorded Video Storage Schedule.....	127
5.8 Configuring Snapshot Settings.....	127
5.8.1 Configuring Snapshot Trigger.....	127
5.8.2 Configuring Snapshot Storage Schedule	129
5.8.3 Backing up Snapshots to FTP	129
5.9 Playing Back Video.....	130
5.9.1 Enabling Record Control	130
5.9.2 Instant Playback	131
5.9.3 Video Playback.....	131
5.9.4 Smart Search.....	138
5.9.5 Showing AI Rule during Playback.....	138
5.9.6 Marking and Playing Back Video.....	139
5.9.7 Playing Back Snapshots.....	142
5.9.8 Playing Back Splices	142
5.9.9 Using the File List.....	143
5.10 Alarm Events Settings.....	144
5.10.1 Alarm Information.....	144
5.10.2 Alarm Input Settings	145
5.10.3 Alarm Output Settings	151
5.10.4 Video Detection	155
5.10.5 System Events.....	162
5.10.6 Configuring Disarming.....	165
5.11 AI Function.....	166
5.11.1 Configuring AI Mode.....	166

5.11.2 For Pro AI Series	166
5.11.3 For Lite AI Series.....	204
5.11.4 Configuring IVS Mode	240
5.11.5 Configuring Smart Schedule.....	241
5.12 IoT Function.....	242
5.12.1 Configuring Sensor Settings	242
5.12.2 Configuring Temperature and Humidity Camera.....	249
5.12.3 Configuring Wireless Siren.....	260
5.13 Configuring POS Settings.....	260
5.13.1 Searching the Transaction Records	261
5.13.2 Configuring POS Settings.....	261
5.14 Configuring Backup Settings	263
5.14.1 Finding USB Device	263
5.14.2 Backing up Files	264
5.15 Network Management	265
5.15.1 Configuring Network Settings.....	265
5.15.2 Configuring Network Testing Settings	282
5.16 Configuring Account Settings	285
5.16.1 Configuring User Account.....	286
5.16.2 Configuring Group Account.....	291
5.16.3 Configuring ONVIF Users.....	295
5.17 Audio Management.....	296
5.17.1 Configuring Audio Files.....	296
5.17.2 Configuring Playing Schedule for Audio Files	297
5.18 Storage Management.....	298
5.18.1 Configuring Basic Settings.....	298
5.18.2 Configuring the Recording and Snapshot Schedule	299
5.18.3 Configuring Disk Manager	299
5.18.4 Configuring Record	301
5.18.5 Configuring Advance Settings	301
5.18.6 Configuring Disk Quota	303
5.18.7 Configuring HDD Detecting Settings	306
5.18.8 Configuring Record Estimate	308
5.18.9 Configuring FTP Storage Settings.....	310
5.19 Security Center	312
5.19.1 Security Status.....	312
5.19.2 System Service.....	313
5.19.3 Attack Defense	317
5.19.4 CA Certificate	321
5.19.5 Audio/Video Encryption	324
5.19.6 Security Warning	326
5.20 Configuring System Settings.....	329
5.20.1 Configuring General System Settings.....	329
5.20.2 Configuring RS-232 Settings.....	330
5.20.3 Configuring System Maintenance Settings.....	331

5.20.4 Exporting and Importing System Settings	332
5.20.5 Restoring Default Settings.....	334
5.20.6 Updating the Device	335
5.20.7 Exporting Intelligent Diagnosis Data.....	338
5.21 Viewing Information.....	338
5.21.1 Viewing Version Details.....	338
5.21.2 Viewing Log Information.....	338
5.21.3 Viewing Event Information	340
5.21.4 Viewing Network Information	341
5.21.5 Viewing HDD Information.....	343
5.21.6 Viewing Channel Information.....	344
5.21.7 Viewing Data Stream Information.....	345
5.22 Logging out of the Device.....	346
6 Web Operations	347
6.1 Connecting to Network.....	347
6.2 Logging in to the Web.....	347
6.3 Introducing Web Main Menu.....	348
6.4 Viewing Open-source Software Notice.....	349
7 FAQ	351
Appendix 1 Glossary	357
Appendix 2 HDD Capacity Calculation.....	359
Appendix 3 Compatible Backup Devices.....	361
Appendix 3.1 Compatible USB List.....	361
Appendix 3.2 Compatible SD Card List.....	362
Appendix 3.3 Compatible Portable HDD List	362
Appendix 3.4 Compatible USB DVD List.....	362
Appendix 3.5 Compatible SATA DVD List.....	363
Appendix 3.6 Compatible SATA HDD List	363
Appendix 4 Compatible CD/DVD Burner List.....	368
Appendix 5 Compatible Displayer List.....	369
Appendix 6 Compatible Switcher.....	370
Appendix 7 Earthing	371
Appendix 7.1 What is the Surge.....	371
Appendix 7.2 The Earthing Modes	372
Appendix 7.3 Thunder Proof Ground Method in the Monitor System.....	373
Appendix 7.4 The Shortcut Way to Check the Electric System by Digital Multimeter.....	374
Appendix 8 RJ45-RS232 Connection Cable Definition.....	377
Appendix 9 Cybersecurity Recommendations	379

1 Introduction

1.1 Overview

The Device is an excellent digital monitor product for security industry. The embedded LINUX OS assures the stable operation. The H.265 and G.711 technologies assure the high quality image and low bit stream. The frame-by-frame play function displays more details for analysis, and provides the functions such as record, playback, and monitor and assures the synchronization for audio and video. The Device also adopts the advanced control technology and great network data transmission capability.

The Device adopts embedded design to achieve high security and reliability. It can work in the local end and, with strong networking capability it can get connected to the professional surveillance software (Smart PSS) to form a security network to show its powerful remote monitoring function.

The Device is applicable to the areas such as bank, telecom, electricity, traffic, intelligent residential district, factory, warehouse, resources, and water conservancy facilities.

1.2 Functions



The functions might be different depending on the software and hardware versions of the model you purchased.

AI Function

- Support face detection that analyzes the attributes such as age, gender, glasses, beard, mask, and then make structured of these data to store for quick search.
- Support face recognition that compares the captured face snapshot with the face database and link the configured alarms (face detection should be enabled).
- Support searching by picture that is convenient for finding the target picture from database.
- Support 16 channel IVS function that includes tripwire and intrusion detection. The IVS function can avoid wrong alarms by filtering the factors such as rains, light, and animals.
- Calculate the quantity of detected humans within 24 hours.
- Detect the vehicles passing by within 24 hours.

Real-time Surveillance

- Support VGA port and HDMI port to realize the surveillance through monitors.
- Support HDMI, VGA, and TV output at the same time.

IoT Management

Provide specific management module for IoT features including humidity and temperature data reports and alarms linkage.

Sensor Integration

Integrate coaxial cameras with diverse array of sensors such as temperature, humidity and wireless alarm devices.

Storage Management

- Special data format to guarantee data security and avoid the risk of modifying data viciously.
- Support digital watermark.

Compression Format

Support multiple-channel audio and video signal. An independent hardware decodes the audio and video signal from each channel to maintain video and audio synchronization.

Backup Function

- Support backup operation through USB port (such as USB storage disk, portable HDD, and burner).
- Client-end user can download the file from local HDD through network to backup.

Record & Playback

- Support each channel real-time record independently, and simultaneously support the functions such as search, backward play, network monitor, record search, and download.
- Support various playback modes: slow play, fast play, backward play and frame by frame play.
- Support time title overlay so that you can view event accurate occurred time.
- Support zooming in the selected area in the live view.

Network Operation

Support network remote real-time monitor, remote record search and remote PTZ control.

Alarm Activation

- Several relay alarm outputs to realize alarm activation and on-site light control.
- The alarm input port and output port have the protection circuit to guarantee the Device safety.

Communication Port

- RS-485 port can realize alarm input and PTZ control.
- RS-232 port can connect to keyboard, COM port of PC or the matrix control.
- Standard Ethernet port can realize network remote access function.
- The dual-network port has the multi-address, fault tolerance, load balance setup mode.

PTZ Control

Support PTZ decoder through RS-485 port.

Intelligent Operation

- Support mouse operation function.
- Support "copy and paste" function for the same settings.

UPnP (Universal Plug and Play)

Establish mapping connection between LAN and WAN through UPnP protocol.

Camera Self-adaptive

Auto-recognize and work with the PAL or NTSC camera and HD camera.

2 Getting Started

2.1 Checking the Components



The actual appearance, component, or quantity might be different depending on the model you purchased.

When you receive the Device, check against the following checking list. If any of the items are missing or damaged, contact the local retailer or after-sales engineer immediately.

Table 2-1 Checking list

No.	Checking Items		Requirements
1	Package	Appearance	No obvious damage.
		Packing materials	No broken or distorted positions that could be caused by hit.
2	Labels	Labels on the device	Not torn up.  Do not tear up or throw away the labels; otherwise the warranty services are not ensured. You need to provide the serial number of the product when you call the after-sales service.
3	Device	Appearance	No obvious damage.
		Data cables, power cables, fan cables, mainboard	No connection loose.

2.2 Installing HDD

Check whether the HDD is already installed in the Device when you first time using the Device. We recommend you to use the HDD recommended officially. Do not use the PC HDD.



Shut down the device and then unplug the power cable before you open the case to replace the HDD.

2.2.1 DH-XVR42xxAN-I/DH-XVR42xxAN-I(V2.0)/DH-XVR52xxA-I2/DH-XVR52xxA-I3/DH-XVR52xxA-4KL-I2/DH-XVR52xxA-4KL-I3/DH-XVR52xxAN-I2/DH-XVR52xxAN-I3/DH-XVR52xxAN-4KL-I2/DH-XVR52xxAN-4KL-I3/DH-XVR72xxA-4K-I2/DH-XVR72xxA-4KL-I/DH-XVR7216AN-4K-I2/DH-XVR82xxA-4K-I/DH-XVR82xxA-4KL-I

Step 1 Remove the screws to take off the cover.

Figure 2-1 Remove screws

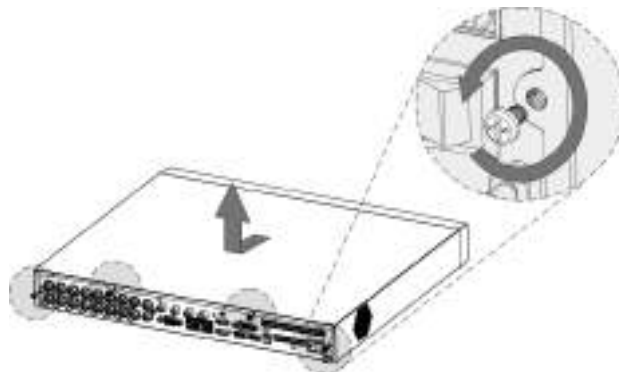

Step 2 Put two screws on the HDD and twist one turn.

Figure 2-2 Put screws

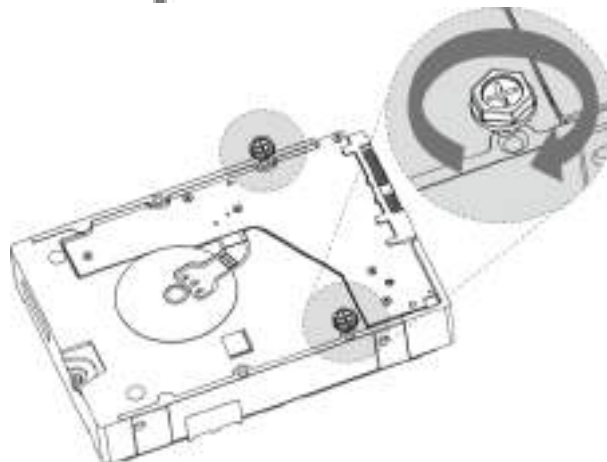

Step 3 Align the two screws with the holes on the device.

Figure 2-3 Align screws

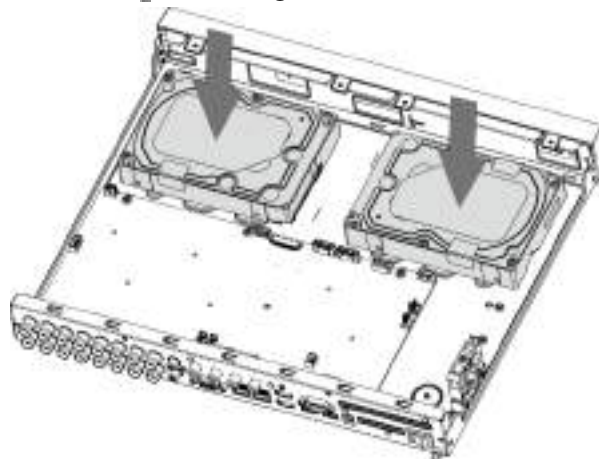

- Step 4** Turn the device and put in the other two screws, and then fasten all screws to fix the HDD to the device.

Figure 2-4 Fasten screws

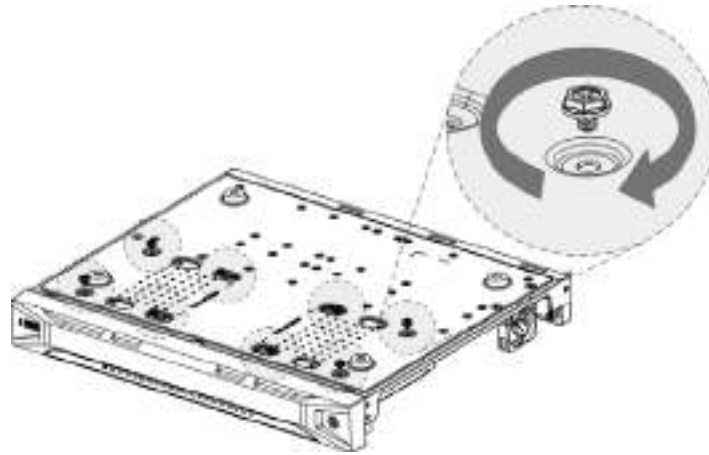

- Step 5** Use power cable and data cable to connect the device and HDD.

Figure 2-5 Connect cables

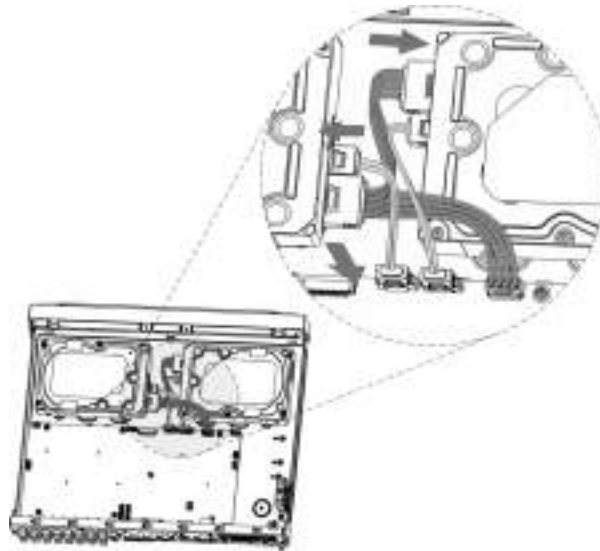

- Step 6** Put back the cover and fasten the screws.

Figure 2-6 Put back cover

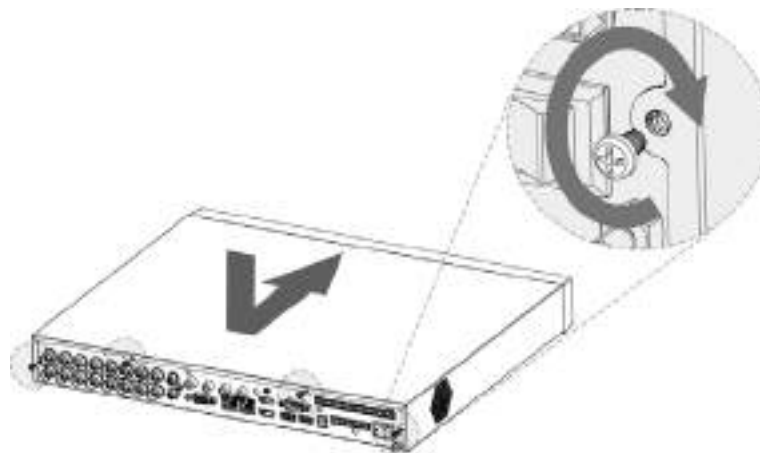

2.2.2 DH-XVR58xxS-I2/DH-XVR58xxS-4KL-I2/DH-XVR58xxS-4KL-I2-LP/DH-XVR78xxS-4K-I2/DH-XVR78xxS-4KL-X-LP-V2/DH-XVR88xxS-4KL-I/

Step 1 Remove the screws from the chassis.

Figure 2-7 Remove screws

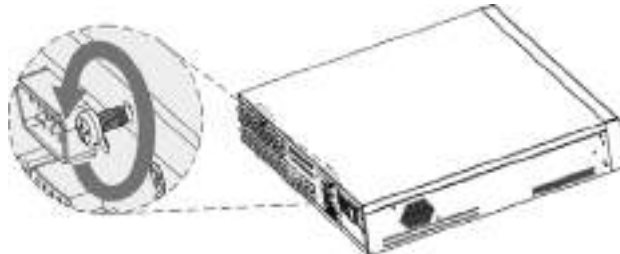

Step 2 Take off the cover of the chassis.

Figure 2-8 Take off cover

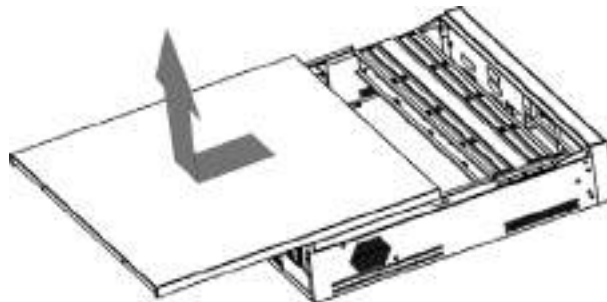

Step 3 Remove the screws from the drive bracket to take it off.

Figure 2-9 Take off drive bracket

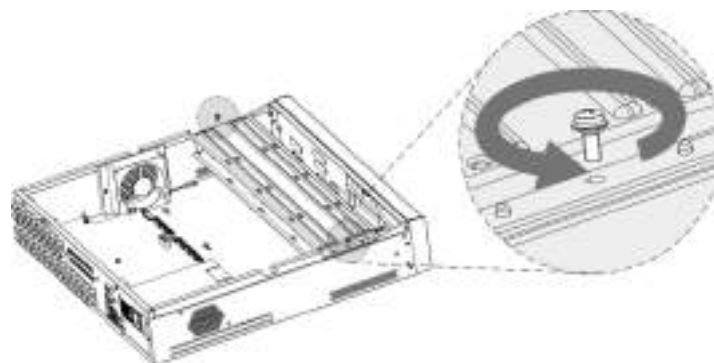

Step 4 Align the four screw holes on the disk to those on the drive bracket and fix the disk on the bracket.

Figure 2-10 Fix disk

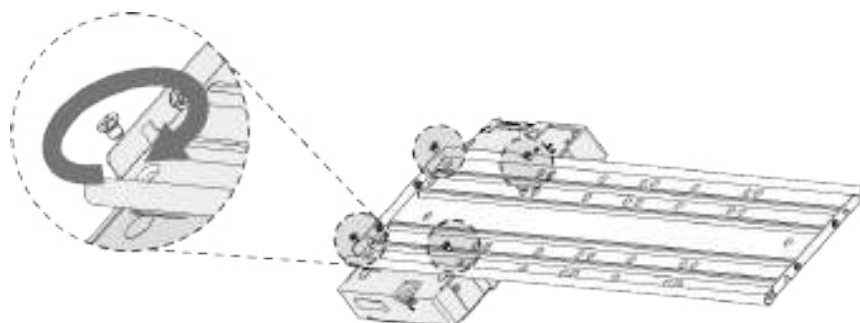

Step 5 Fix other disks on the bracket as needed.

Figure 2-11 Fix other disks

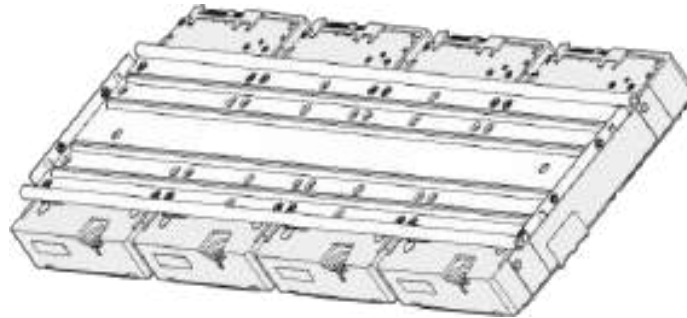

Step 6 Fix the two drive brackets.



This is only needed on models with 8 bays.

Figure 2-12 Fix drive brackets

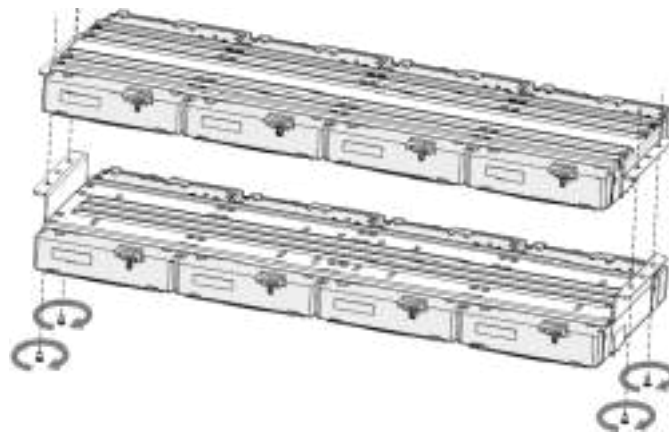

Step 7 Put the drive brackets back and fix them in the DVR.

Figure 2-13 Put back drive bracket

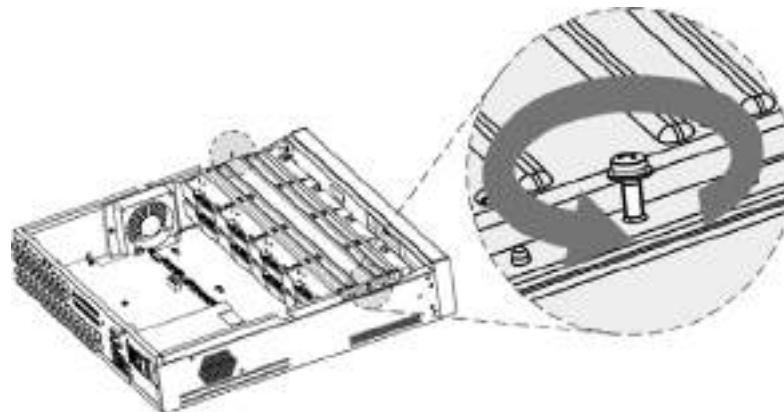

Step 8 Connect the disks and the DVR with power cable and data cable.



The following figure shows the connection of 4-bay model for example.

Figure 2-14 Connect cables

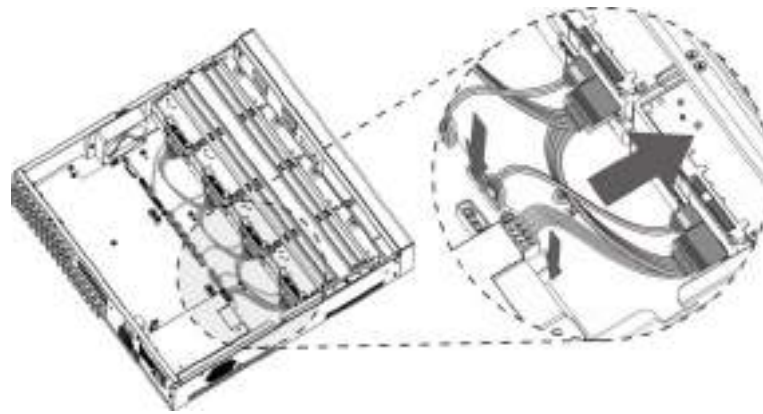

Step 9 Put the cover back and fasten the screws.

Figure 2-15 Put back cover

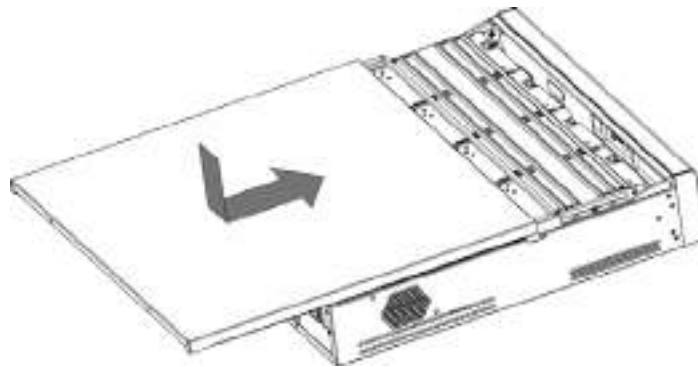

2.2.3 DH-XVR54xxL-I2/DH-XVR54xxL-4KL-I2/DH-XVR74xxL-4K-I2

Step 1 Remove the fixing screws from the rear panel.

Figure 2-16 Remove screws

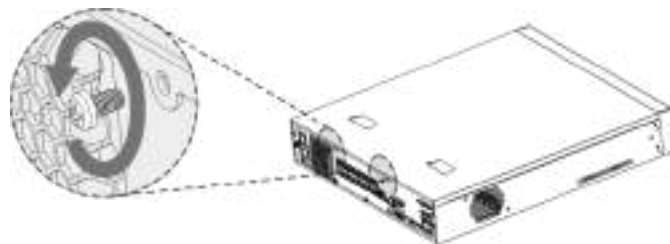

Step 2 Remove the cover along the direction shown in the following arrow.

Figure 2-17 Remove cover

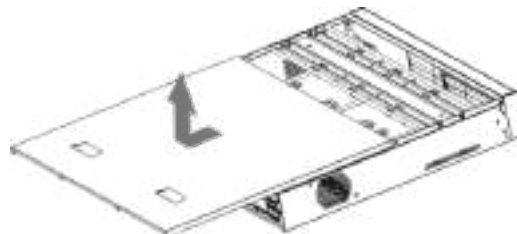

Step 3 Remove the screws on the sides of HDD bracket to take out the bracket.
For the way to remove the bracket, see the following figure.

Figure 2-18 Remove bracket

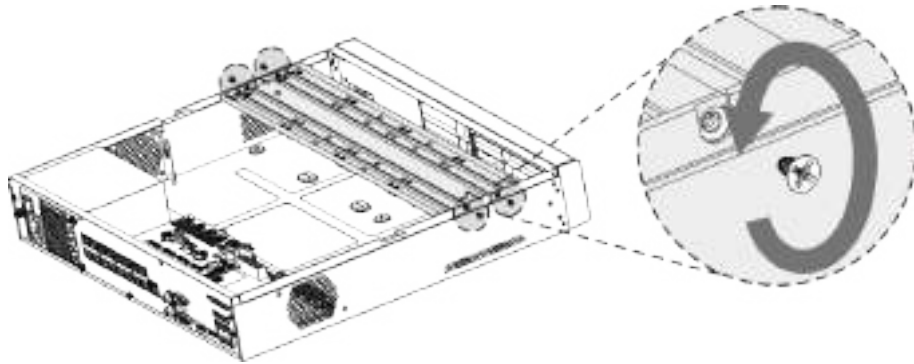

Step 4 Match the four screw holes on the HDD with the four holes on the bracket and then fasten the screws. The HDD is fixed to the bracket.

Figure 2-19 Fix HDD

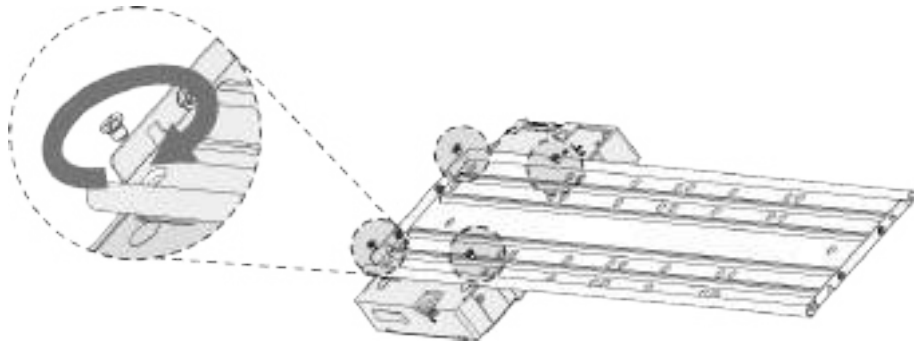

Step 5 Install the other HDDs.

Figure 2-20 Install other HDDs

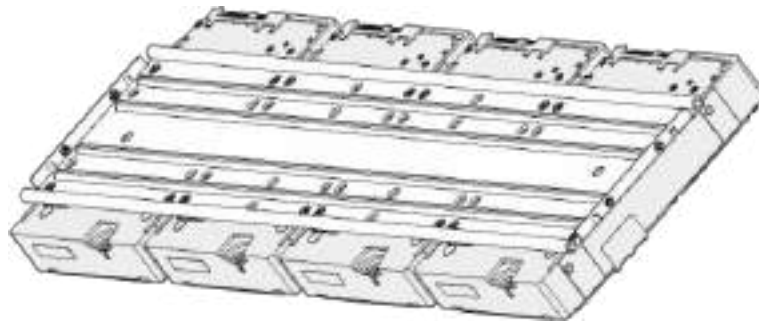

Step 6 Place the bracket to the device and then fasten the screws on the sides of the bracket.

Figure 2-21 Fasten screws

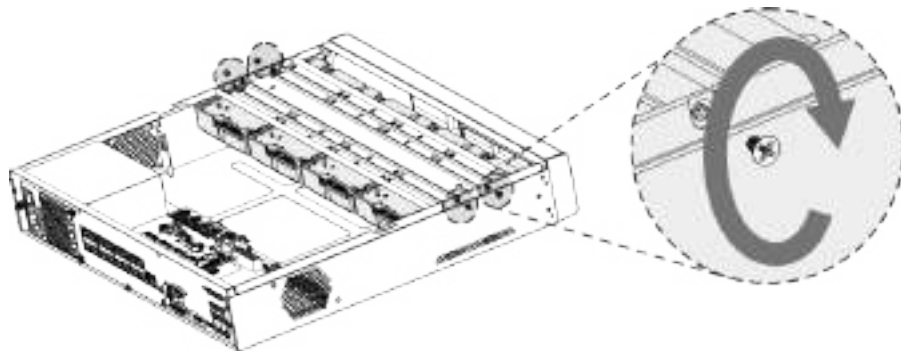

Step 7 Connect the HDD data cable and power cable to the device.

Figure 2-22 Connect cables

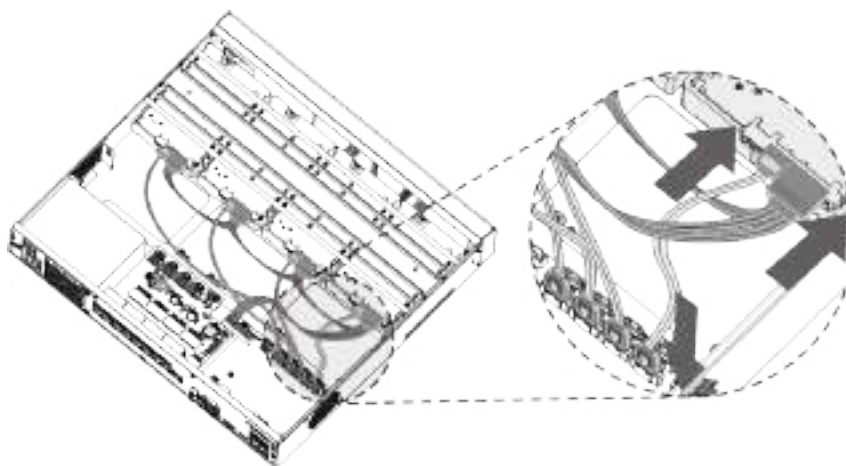

Step 8 Put back the cover and fasten the screws on the rear panel to complete the installation.

Figure 2-23 Put back cover

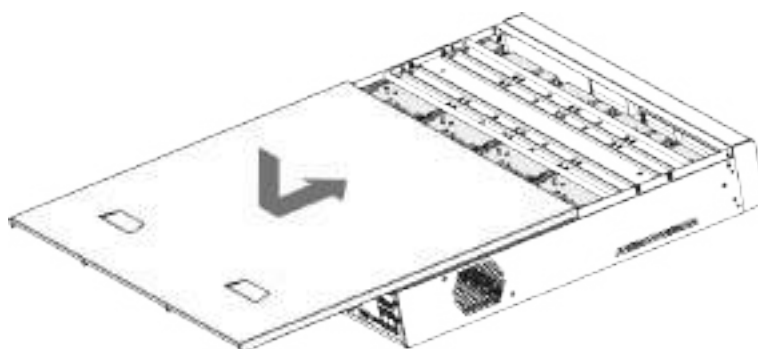

2.2.4 DH-XVR1Bxx-I/DH-XVR1BxxH-I/DH-XVR41xxC-I/DH-XVR41xxHS-I/DH-XVR51xxH-I/DH-XVR51xxH-I2/DH-XVR51xxH-I3/DH-XVR51xxH-4KL-I2/DH-XVR51xxH-4KL-I3/DH-XVR51xxHE-I2/DH-XVR51xxHE-I3/DH-XVR51xxHE-4KL-I2/DH-XVR51xxHE-4KL-I3/DH-XVR51xxHS-I2/DH-XVR51xxHS-I3/DH-XVR51xxHS-4KL-I2/DH-XVR51xxHS-4KL-I3/DH-XVR71xxH-4K-I2/DH-XVR71xxHE-4KL-I/DH-XVR71xxHE-4K-I2

Step 1 Remove the screws on the cover.

Figure 2-24 Remove screws



Step 2 Remove the cover.

Figure 2-25 Remove cover

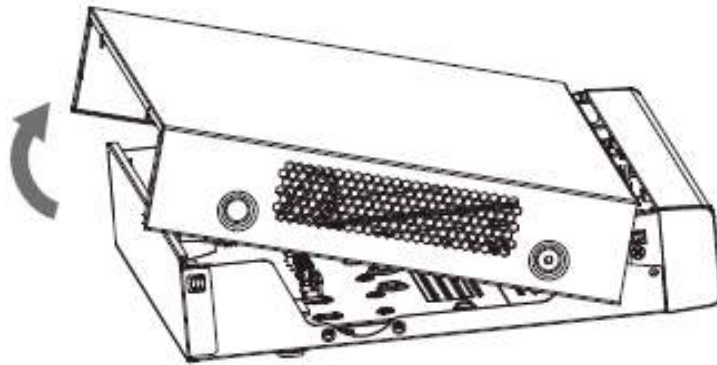

Step 3 Align the screws of the HDD with the holes on the back of the device and fasten them.

Figure 2-26 Fasten screws

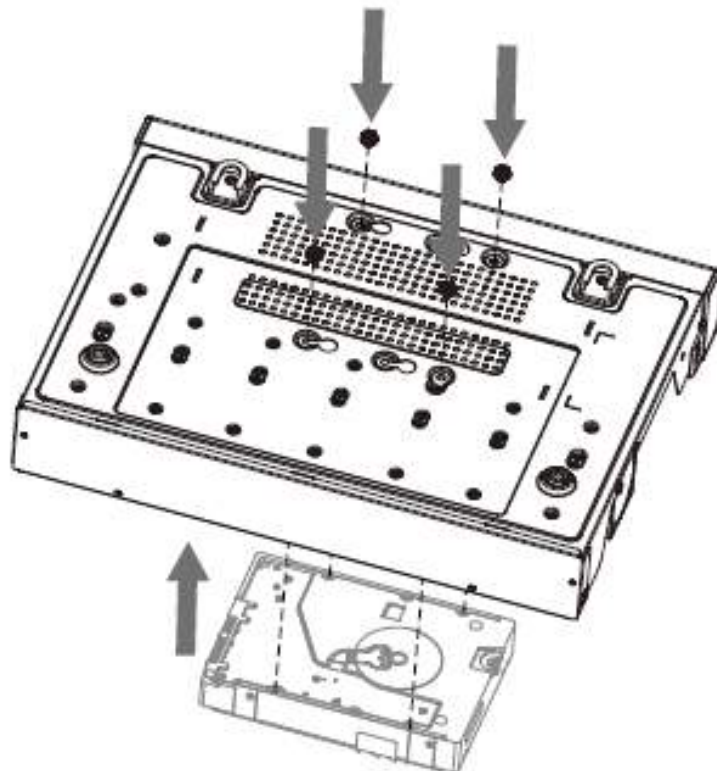

Step 4 Connect the HDD cable and the power cable to the mainboard.

Figure 2-27 Connect cables

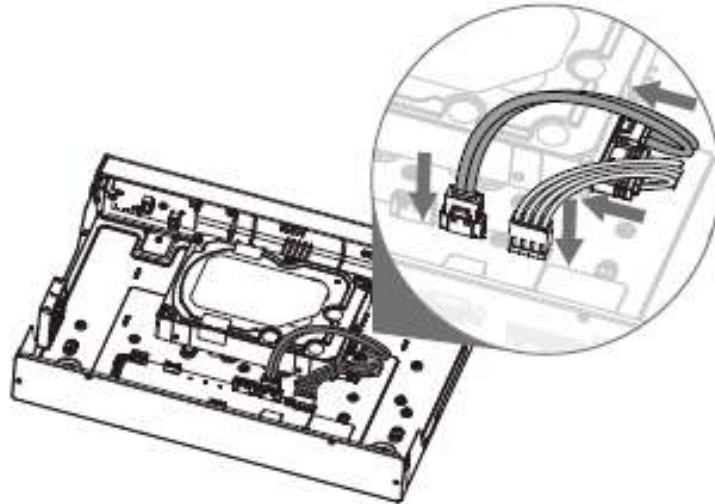

Step 5 Put back the cover.

Figure 2-28 Put back cover

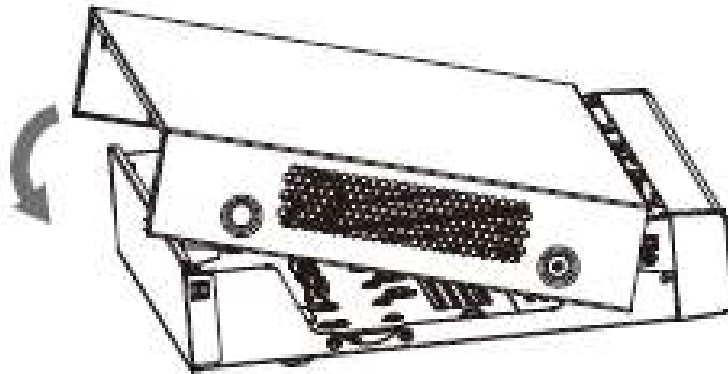

Step 6 Fasten the screws.

Figure 2-29 Fasten screws

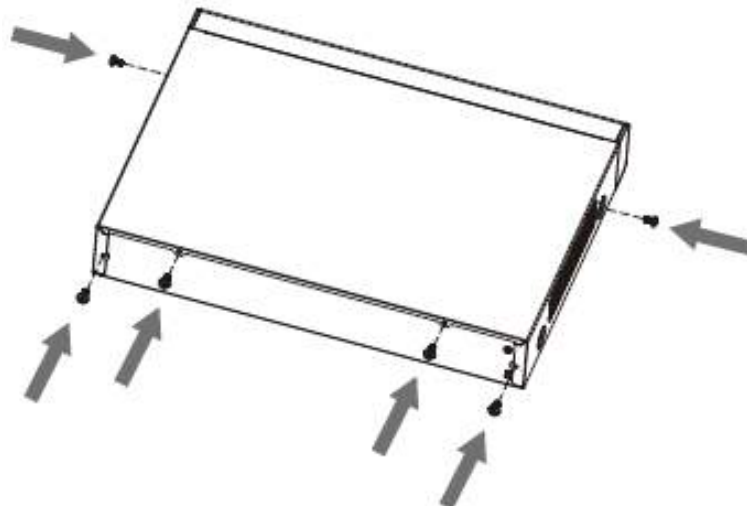

2.2.5 DH-XVR51xxC-I3/DH-XVR51xxC-4KL-I3

Step 1 Remove the screws.

Figure 2-30 Remove screws

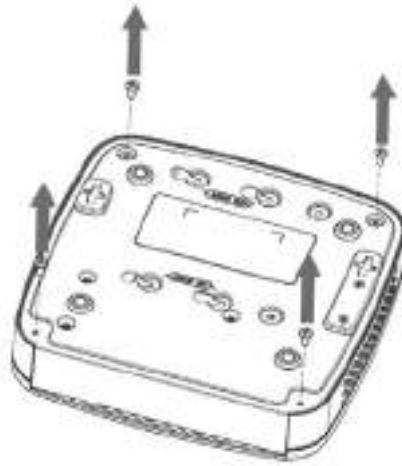

Step 2 Take off the cover.

Figure 2-31 Take off cover



Step 3 Align the screws with the holes on the DVR and fasten them.

Figure 2-32 Install HDD



Step 4 Use the HDD cable and power cable to connect HDD and mainboard.

Figure 2-33 Connect cables

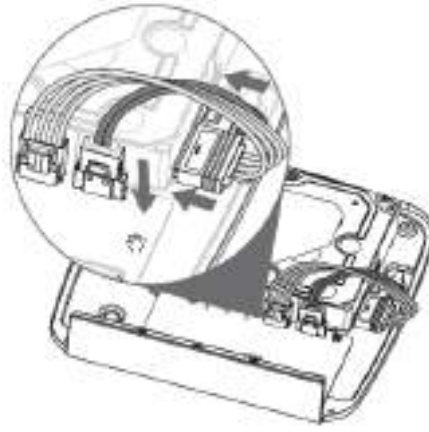

Step 5 Put back the cover.

Figure 2-34 Put back cover



Step 6 Fasten the screws.

Figure 2-35 Fasten screws

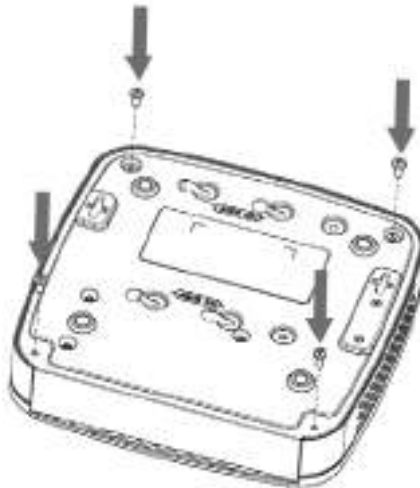

3 The Grand Tour

This chapter introduces various components of the Device, remote control and mouse operations.

3.1 Front Panel

3.1.1 DH-XVR51xxH-I

Figure 3-1 Front panel

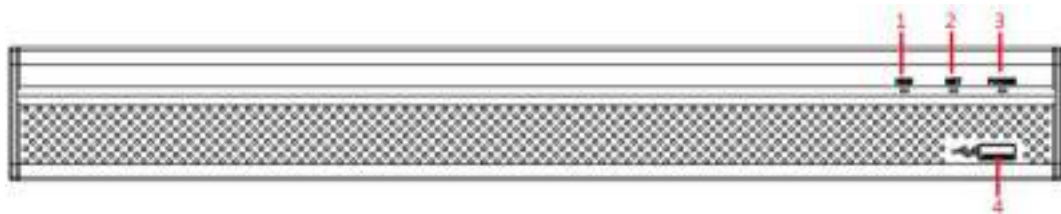

Table 3-1 Front panel description

No.	Port Name	Function
1	HDD	Glowes blue when HDD status is abnormal.
2	NET	Glowes blue when network status is abnormal.
3	POWER	Glowes blue when the power is connected properly.
4	USB port	Connects to peripheral devices such as USB storage device, keyboard, and mouse.

3.1.2 DH-XVR71xxH-4K-I2/DH-XVR71xxHE-4K-I2/DH-XVR71xxHE-4KL-

I

Figure 3-2 Front panel



Table 3-2 Front panel description

No.	Port Name	Function
1	USB port	Connects to peripheral devices such as USB storage device, keyboard and mouse.

3.1.3 DH-XVR72xxA-4KL-I/DH-XVR72xxAN-4K-I2

Figure 3-3 Front panel



Table 3-3 Front panel description

No.	Port Name	Function
1	IR receiver	Receives infrared signal from remote control.
2	USB port	Connects to the external devices such as keyboard, mouse, and USB storage device.

3.1.4 DH-XVR82xxA-4K-I/DH-XVR82xxA-4KL-I

Figure 3-4 Front panel



Table 3-4 Front panel description

No.	Indicator/Port	Function
1	USB port	Connects to peripheral devices such as USB storage device, keyboard, and mouse.
2	IR receiver	Receives infrared signal from remote control.

3.1.5 DH-XVR41xxC-I/DH-XVR41xxHS-I/DH-XVR42xxAN-I/DH-XVR42xxAN-I(V2.0)/DH-XVR51xxH-I2/DH-XVR51xxH-I3/DH-XVR51xxH-4KL-I2/DH-XVR51xxH-4KL-I3/DH-XVR51xxHE-I2/DH-XVR51xxHE-I3/DH-XVR51xxHE-4KL-I2/DH-XVR51xxHE-4KL-I3/DH-XVR51xxHS-I2/DH-XVR51xxHS-I3/DH-XVR51xxHS-4KL-I2/DH-XVR51xxHS-4KL-I3/DH-XVR52xxA-I2/DH-XVR52xxA-I3/DH-XVR52xxA-4KL-I2/DH-XVR52xxA-4KL-I3/DH-XVR52xxAN-I2/DH-XVR52xxAN-I3/DH-XVR52xxAN-4KL-I2/DH-XVR52xxAN-4KL-I3

Figure 3-5 Front panel

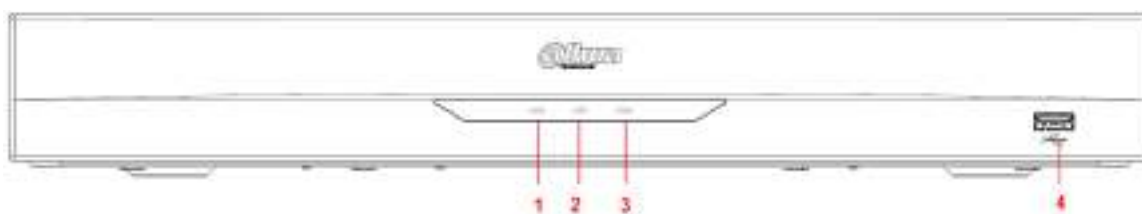

Table 3-5 Front panel description

No.	Port Name	Function
1	HDD	Glowes when HDD status is abnormal.
2	NET	Glowes when network status is abnormal.
3	POWER	Glowes when the power is connected properly.
4	USB port	Connects to peripheral devices such as USB storage device, keyboard, and mouse.

3.1.6 DH-XVR78xxS-4K-I2/DH-XVR78xxS-4KL-X-LP-V2/DH-XVR88xxS-4KL-I

Figure 3-6 Front panel



Table 3-6 Front panel description

No.	Port Name	Function
1	IR receiver	Receives infrared signal from remote control.
2	USB port	Connects to peripheral devices such as USB storage device, keyboard, and mouse.

3.1.7 DH-XVR74xxL-4K-I2

Figure 3-7 Front panel



Table 3-7 Front panel description

No.	Port Name	Function
1	IR receiver	Receives infrared signal from remote control.
2	USB port	Connects to peripheral devices such as USB storage device, keyboard, and mouse.

3.1.8 DH-XVR54xxL-I2/DH-XVR54xxL-4KL-I2

Figure 3-8 Front panel

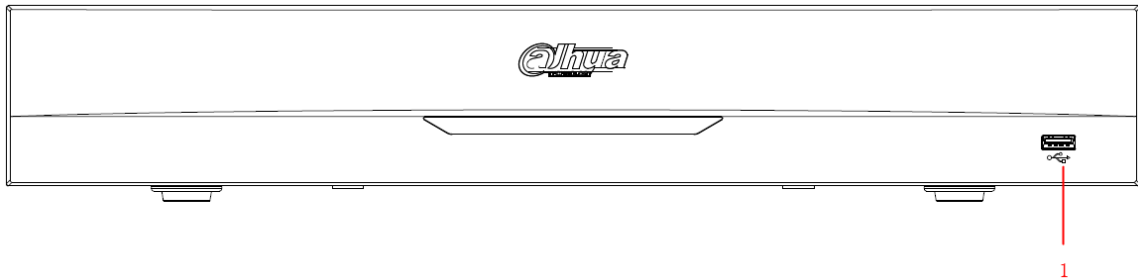

Table 3-8 Front panel description

No.	Port Name	Function
1	USB port	Connects to peripheral devices such as USB storage device, keyboard, and mouse.

3.1.9 DH-XVR58xxS-I2/DH-XVR58xxS-4KL-I2/DH-XVR58xxS-4KL-I2-LP

Figure 3-9 Front panel

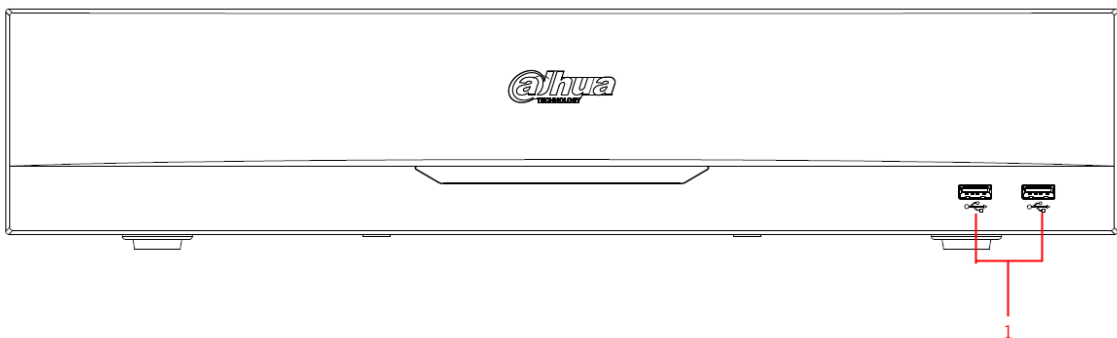

Table 3-9 Front panel description

No.	Port Name	Function
1	USB ports	Connect to peripheral devices such as USB storage device, keyboard, and mouse.

3.1.10 DH-XVR1Bxx-I/DH-XVR1BxxH-I

Figure 3-10 Front panel





3.1.11 DH-XVR51xxC-I3/DH-XVR51xxC-4KL-I3

Figure 3-11 Front panel



Table 3-10 Front panel description

Icon	Name	Function
	HDD status indicator	<ul style="list-style-type: none"> The indicator is off when the HDD is running normally. The indicator glows blue when the HDD is in malfunction.
	Power status indicator	<ul style="list-style-type: none"> The indicator is off when the power is connected abnormally. The indicator glows blue when the power is connected normally.
	Network status indicator	<ul style="list-style-type: none"> The indicator is off when the network connection is correct. The indicator glows blue when the network connection is abnormal.

3.2 Rear Panel

3.2.1 DH-XVR51xxH-I/DH-XVR51xxH-I2/DH-XVR51xxH-I3/DH-XVR51xxH-4KL-I2/DH-XVR51xxH-4KL-I3/DH-XVR51xxHE-I2/DH-XVR51xxHE-I3/DH-XVR51xxHE-4KL-I2/DH-XVR51xxHE-4KL-I3/DH-XVR71xxH-4K-I2/DH-XVR71xxHE-4K-I2/DH-XVR71xxHE-4KL-I

Figure 3-12 Rear panel

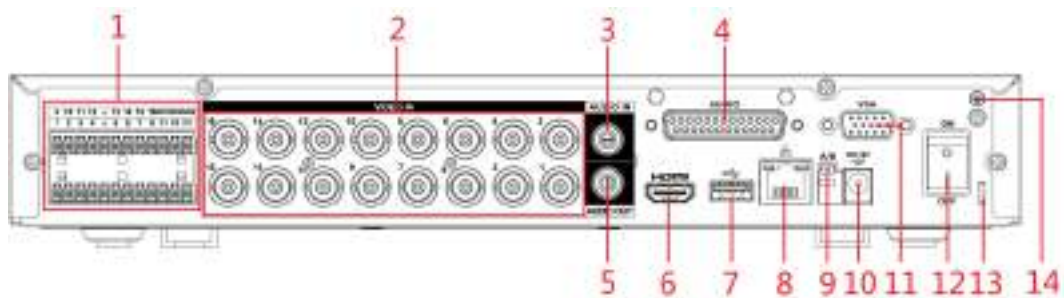



Table 3-11 Rear panel description

No.	Port Name	Function
1	Alarm input port 1-16	Four groups of alarm input ports (Group 1: port 1 to port 4; Group 2: port 5 to port 8; Group 3: port 9 to port 12; Group 4: port 13 to port 16). These ports receive the signal from the external alarm source. There are two types: NO (Normally Open) and NC (Normally Closed).  When your alarm input device is using external power, make sure the alarm input device and the Device have the same ground.
	Alarm output port 1-3 (NO1-NO3; C1-C3)	<ul style="list-style-type: none"> Three groups of alarm output ports (Group 1: port NO1-C1, Group 2: port NO2-C2, Group 3: port NO3-C3). These ports output alarm signal to the alarm device. Make sure power supply to the external alarm device. NO: Normally open alarm output port. C: Alarm output public end.
		Ground.
2	Video input port	Connects to analog camera to input video signal.
3	Audio input port	Receives audio signal output from the devices such as microphone. It corresponds to video input port 1.
4	DB25 port	Connects to the audio splitter taken from the package to convert to audio input port which receives the audio signal from devices such as microphone. It corresponds to video input ports 2-16.

No.	Port Name	Function
5	Audio output port	Outputs audio signal to the devices such as the sound box.
6	HDMI port	High definition audio and video signal output port. The port outputs the uncompressed high definition video and multi-channel audio data to the connected display with HDMI port.
7	USB port	Connects to external devices such as USB storage device, keyboard and mouse.
8	Network port	Connects to Ethernet port.
9	RS-485 communication port	Connects to the control devices such as speed dome PTZ. RS-485_A port is connected by the cable A and RS-485_B is connected to the cable B.
10	Power input port	Inputs 12 VDC power.
11	VGA port	Outputs analog video data to the connected display with VGA port.
12	Power button	Turns on/off the DVR.
13	Power cable fastener	Use a cable tie to secure the power cable on the DVR to prevent loss.
14		Ground terminal.

3.2.2 DH-XVR41xxC-I/DH-XVR41xxHS-I/DH-XVR51xxHS-I2/DH-XVR51xxHS-I3/DH-XVR51xxHS-4KL-I2/DH-XVR51xxHS-4KL-I3

Figure 3-13 Rear panel

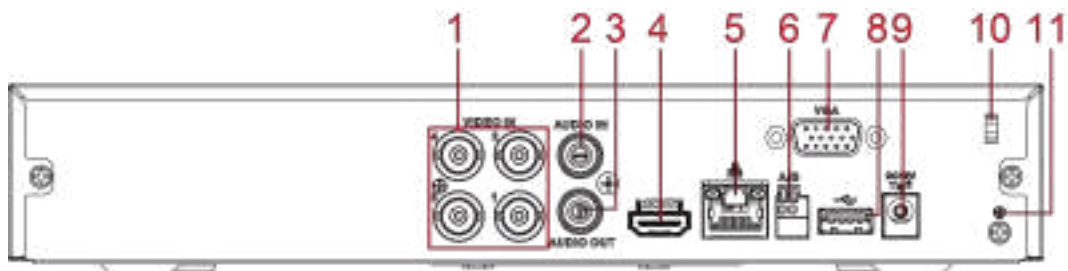

Table 3-12 Rear panel description

No.	Port Name	Function
1	Video input port	Connects to analog camera to input video signal.
2	Audio input port	Receives audio signal output from the devices such as microphone.
3	Audio output port	Outputs audio signal to the devices such as the sound box.
4	HDMI port	High definition audio and video signal output port. The port outputs the uncompressed high definition video and multi-channel audio data to the connected display with HDMI port.
5	Network port	Connects to Ethernet port.

No.	Port Name	Function
6	RS-485 communication port	Connects to the control devices such as speed dome PTZ. RS-485_A port is connected by the cable A and RS-485_B is connected to the cable B.
7	VGA port	Outputs analog video data to the connected display with VGA port.
8	USB port	Connects to external devices such as USB storage device, keyboard and mouse.
9	Power input port	Inputs 12 VDC power.
10	Power cable fastener	Use clamp to secure the power cable on the DVR in case there is any loss.
11		Ground terminal.

3.2.3 DH-XVR52xxA-I2/DH-XVR52xxA-I3/DH-XVR52xxA-4KL-I2/DH-XVR52xxA-4KL-I3/DHXVR42xxAN-I/DH-XVR42xxAN-I(V2.0)/DH-XVR52xxAN-I2/DH-XVR52xxAN-I3/DH-XVR52xxAN-4KL-I2/DH-XVR52xxAN-4KL-I3/DH-XVR72xxA-4K-I2/DH-XVR72xxA-4KL-I/DH-XVR72xxAN-4K-I2

Figure 3-14 Rear panel

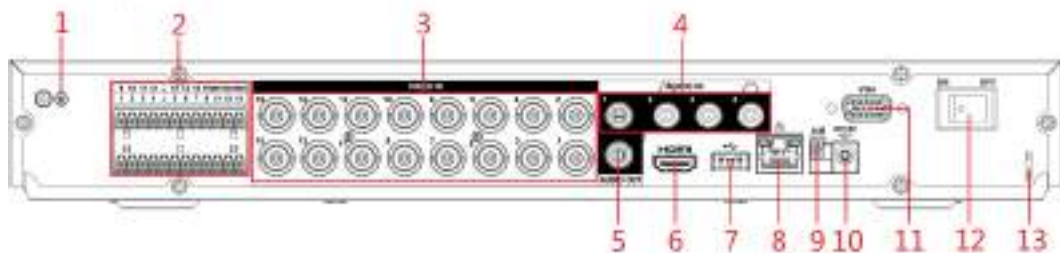

Table 3-13 Rear panel description

No.	Port Name	Function
1		Ground terminal.
2	Alarm input port 1-16	<p>Four groups of alarm input ports (Group 1: port 1 to port 4; Group 2: port 5 to port 8; Group 3: port 9 to port 12; Group 4: port 13 to port 16). These ports receive the signal from the external alarm source. There are two types: NO (Normally Open) and NC (Normally Closed).</p> <p>When your alarm input device is using external power, make sure the alarm input device and the DVR connect to the same ground.</p>

No.	Port Name	Function
	Alarm output port 1-3 (NO1-NO3; C1-C3)	<ul style="list-style-type: none"> Three groups of alarm output ports. (Group 1: port NO1-C1, Group 2: port NO2-C2, Group 3: port NO3-C3). These ports output alarm signal to the alarm device. Make sure power supply to the external alarm device. NO: Normally open alarm output port. C: Alarm output public end.
		Ground.
3	Video input port	Connects to analog camera to input video signal.
4	Audio input port	Receives audio signal output from the devices such as microphone.
5	Audio output port	Outputs audio signal to the devices such as the sound box.
6	HDMI port	High definition audio and video signal output port. The port outputs the uncompressed high definition video and multi-channel audio data to the connected display with HDMI port.
7	USB port	Connects to the external devices such as keyboard, mouse, and USB storage device.
8	Network port	Connects to Ethernet port.
9	RS-485 communication port	Connects to the control devices such as speed dome PTZ. RS-485_A port is connected by the cable A and RS-485_B is connected to the cable B.
10	Power input port	Inputs 12 VDC power.
11	VGA port	Outputs analog video data to the connected display with VGA port.
12	Power button	Turns on/off the DVR.
13	Power cable fastener	Use clamp to secure the power cable on the DVR in case there is any loss.

3.2.4 DH-XVR82xxA-4K-I/DH-XVR82xxA-4KL-I

Figure 3-15 Rear panel

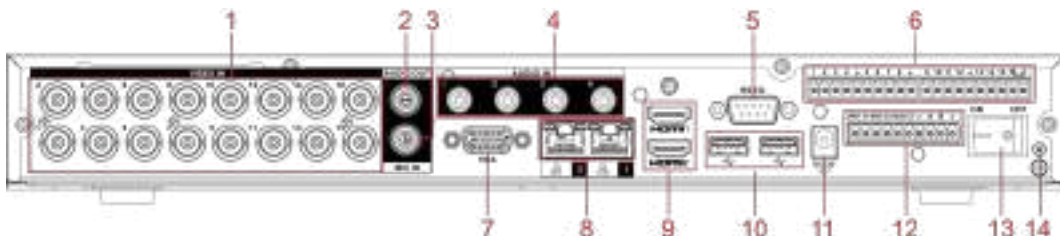





Table 3-14 Rear panel description

No.	Port Name	Function
1	Video input port	Connects to analog camera to input video signal.
2	Audio output port	Outputs audio signal to the devices such as the sound box.

No.	Port Name	Function
3	MIC IN	Two-way talk input port which receives analog audio signal output from the devices such as microphone and pickup.
4	Audio input port	Receives audio signal output from the devices such as microphone.
5	RS-232 debug COM	The port is used for general COM debug to configure IP address or transfer transparent COM data.
6	Alarm input port 1-16	<p>4 groups of alarm input ports (Group 1: port 1 to port 4; Group 2: port 5 to port 8; Group 3: port 9 to port 12; Group 4: port 13 to port 16). These ports receive the signal from the external alarm source. There are two types: NO (normal open) and NC (normal close).</p>  <p>When your alarm input device is using external power, make sure the input device and the DVR connect to the same ground.</p>
		Ground terminal.
7	VGA port	Outputs analog video data to the connected display with VGA port.
8	Network port	Connects to Ethernet port.
9	HDMI port	High definition audio and video signal output port. The port outputs the uncompressed high definition video and multi-channel audio data to the connected display with HDMI port.
10	USB port	Connects to the external devices such as keyboard, mouse, and USB storage device.
11	Power input port	Inputs power.
12	Alarm output port 1-5 (NO1-NO5; C1-C5; NC5)	<ul style="list-style-type: none"> ● 5 groups of alarm output ports (Group 1: port NO1-C1, Group 2: port NO2-C2, Group 3: port NO3-C3, Group 4: port NO4-C4, Group 5: port NO5, C5, NC5). These ports output alarm signal to the alarm device. Make sure power supply to the external alarm device. ● NO: Normal open alarm output port. ● C: Alarm output public end. ● NC: Normal close alarm output port.
13	Power button	Turns on/off the DVR.
14		Ground.

3.2.5 DH-XVR58xxS-I2/DH-XVR58xxS-4KL-I2/DH-XVR78xxS-4K-I2/DH-XVR88xxS-4KL-I

Figure 3-16 Rear panel

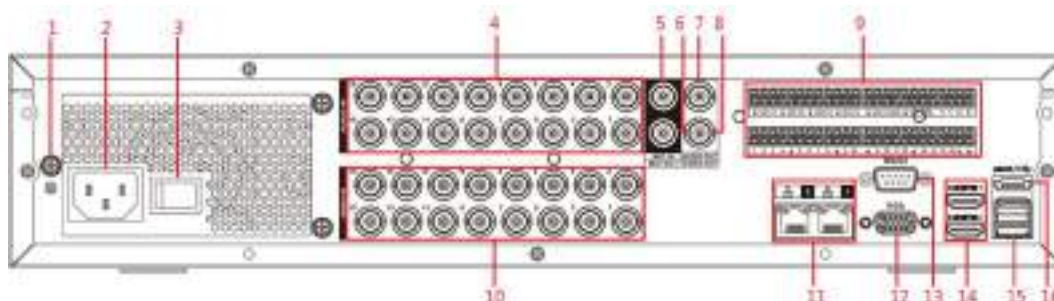



Table 3-15 Rear panel description

No.	Port Name	Function
1	GND	Ground.
2	Power input port	Inputs power.
3	Power button	Turns on/off the Device.
4	Audio input port	Receives the analog audio signal output from the devices such as microphone.
5	Audio input port (MIC IN)	Two-way talk input port which receives the analog audio signal output from the devices such as microphone, pickup.
6	Audio output port (MIC OUT)	Two-way talk output port which outputs the analog audio signal to the devices such as the sound box.
7	Audio output port	Outputs the analog audio signal to the devices such as the sound box.
8	Video output port	Connect to video output devices such as TV.
9	Alarm input port 1-16	<ul style="list-style-type: none"> Four groups of alarm output ports (Group 1: port 1 to port 4; Group 2: port 5 to port 8; Group 3: port 9 to port 12; Group 4: port 13 to port 16). These ports receive the signal from the external alarm source. There are two types; NO (Normally Open) and NC (Normally Closed). When your alarm input device is using external power, make sure the device and the NVR have the same ground.

No.	Port Name	Function
	Alarm output port 1-5 (NO1-NO5; C1-C5; NC5)	<ul style="list-style-type: none"> Five groups of alarm output ports. (Group 1: port NO1-C1, Group 2: port NO2-C2, Group 3: port NO3-C3, Group 4: port NO4-C4, Group 5: port NO5, C5, NC5). These ports output alarm signal to the alarm device. Make sure power supply to the external alarm device. NO: Normally open alarm output port. C: Alarm output public end. NC: Normally closed alarm output port.
	RS-485 communication port	You can connect to the control devices such as speed dome PTZ. RS-485_A port is connected by the cable A and RS-485_B is connected to the cable B.
	Four-wire full-duplex RS-485 port (T+, T-, R+, R-)	Four-wire full-duplex 485 port. T+ and T- is the output wire; R+ and R- is the input wire.
	Control power output (CTRL 12V)	Controls 12 VDC power output. It is to control the on-off alarm relay output.
	12V power output port	Provides power to external devices such as camera and alarm device. Note the supplying power shall be below 1A.
		Ground.
10	Video input port	Connect to analog camera to input video signal.
11	Network port	Connects to Ethernet port.
12	VGA video output	Outputs analog video signal. It can connect to the monitor to view analog video.
13	RS-232 debug COM.	It is for general COM debug to configure IP address or transfer transparent COM data.
14	HDMI port	High definition audio and video signal output port. It outputs the same video source as VGA. It supports 4K resolution output and supports mouse operation and control. Note when the HDMI output resolution is 4K, the VGA output stops.
15	USB port	Connects to the external devices such as keyboard, mouse, and USB storage device.
16	eSATA port	External SATA port which connects to the device with SATA port. Perform the jumper configuration when connecting HDD.

3.2.6 DH-XVR58xxS-4KL-I2-LP/DH-XVR78xxS-4KL-X-LP-V2

Figure 3-17 Rear panel

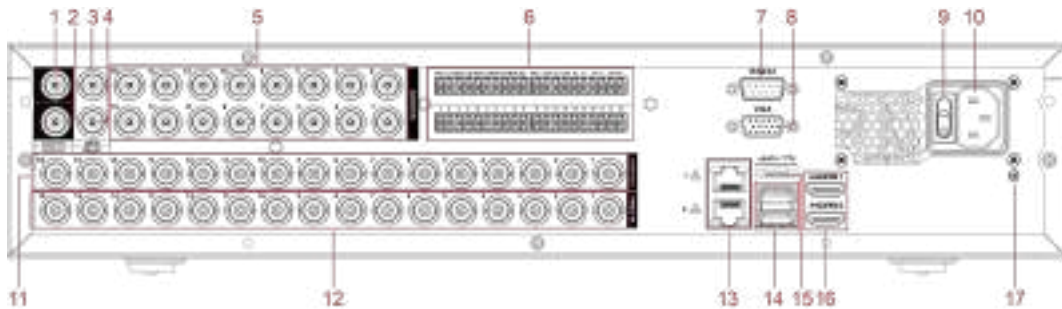

Table 3-16 Rear panel description

No.	Port Name	Function
1	Audio output port	Outputs the analog audio signal to the devices such as the sound box.
2	Video output port	Connect to video output devices such as TV.
3	Audio input port (MIC IN)	Two-way talk input port which receives the analog audio signal output from the devices such as microphone, pickup.
4	Audio output port (MIC OUT)	Two-way talk output port which outputs the analog audio signal to the devices such as the sound box.
5	Audio input port	Receives the analog audio signal output from the devices such as microphone.
6	Alarm input port 1-16	<ul style="list-style-type: none"> Four groups of alarm input ports (Group 1: port 1 to port 4; Group 2: port 5 to port 8; Group 3: port 9 to port 12; Group 4: port 13 to port 16). These ports receive the signal from the external alarm source. There are two types; NO (Normally Open) and NC (Normally Closed). When your alarm input device is using external power, make sure that the device and the NVR have the same ground.
	Alarm output port 1-5 (NO1-NO5; C1-C5; NC5)	<ul style="list-style-type: none"> Five groups of alarm output ports. (Group 1: port NO1-C1, Group 2: port NO2-C2, Group 3: port NO3-C3, Group 4: port NO4-C4, Group 5: port NO5, C5, NC5). These ports output alarm signal to the alarm device. Make sure that power supply to the external alarm device. NO: Normally open alarm output port. C: Alarm output public end. NC: Normally closed alarm output port.
	RS-485 communication port	You can connect to the control devices such as speed dome PTZ. RS-485_A port is connected by the cable A and RS-485_B is connected to the cable B.

No.	Port Name	Function
	Four-wire full-duplex RS-485 port (T+, T-, R+, R-)	Four-wire full-duplex 485 port. T+ and T- is the output wire; R+ and R- is the input wire.
	Control power output (CTRL 12V)	Controls the 6 th channel power output for alarm. <ul style="list-style-type: none"> • Turns off power output when there is alarm output. • Turns on power output when the alarm is cleared.
	12V power output port	Provides power to external devices such as camera and alarm device. Note the supplying power shall be below 1A.
	G	Ground.
7	RS-232 debug COM.	It is for general COM debug to configure IP address or transfer transparent COM data.
8	VGA video output	Outputs analog video signal. It can connect to the monitor to view analog video.
9	Power button	Turns on/off the Device.
10	Power input port	Inputs power.
11	Loop out	Outputs the video signal of the corresponding video input port.
12	Video input port	Connect to analog camera to input video signal.
13	Network port	Connects to Ethernet port.
14	USB port	Connects to the external devices such as keyboard, mouse, and USB storage device.
15	eSATA port	External SATA port which connects to the device with SATA port. Perform the jumper configuration when connecting HDD.
16	HDMI port	High definition audio and video signal output port. It outputs the same video source as VGA. It supports 4K resolution output and supports mouse operation and control. Note when the HDMI output resolution is 4K, the VGA output stops.
17	GND	Ground.

3.2.7 DH-XVR54xxL-I2/DH-XVR54xxL-4KL-I2/DH-XVR74xxL-4K-I2

Figure 3-18 Rear panel

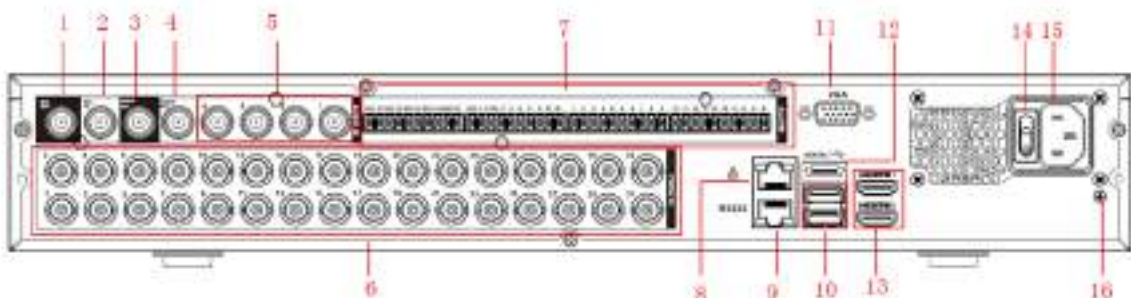



Table 3-17 Rear panel description

No.	Port Name	Function
1	Audio output port (MIC OUT)	Two-way talk output port which outputs the analog audio signal to the devices such as the sound box.
2	Audio input port (MIC IN)	Two-way talk input port which receives the analog audio signal output from the devices such as microphone, pickup.
3	Video output port	Connect to video output devices such as TV.
4	Audio output port	Outputs the analog audio signal to the devices such as the sound box.
5	Audio input port	Receives the analog audio signal output from the devices such as microphone.
6	Video input port	Connect to analog camera to input video signal.
7	Alarm input port 1-16	<ul style="list-style-type: none"> Four groups of alarm output ports (Group 1: port 1 to port 4; Group 2: port 5 to port 8; Group 3: port 9 to port 12; Group 4: port 13 to port 16). These ports receive the signal from the external alarm source. There are two types; NO (Normally Open) and NC (Normally Closed). When your alarm input device is using external power, make sure the device and the NVR have the same ground.
	Alarm output port 1-5 (NO1-NO5; C1-C5; NC5)	<ul style="list-style-type: none"> Five groups of alarm output ports. (Group 1: port NO1-C1, Group 2: port NO2-C2, Group 3: port NO3-C3, Group 4: port NO4-C4, Group 5: port NO5, C5, NC5). These ports output alarm signal to the alarm device. Make sure power supply to the external alarm device. NO: Normally open alarm output port. C: Alarm output public end. NC: Normally closed alarm output port.
	RS-485 communication port	You can connect to the control devices such as speed dome PTZ. RS-485_A port is connected by the cable A and RS-485_B is connected to the cable B.
	Four-wire full-duplex RS-485 port (T+, T-, R+, R-)	Four-wire full-duplex 485 port. T+ and T- is the output wire; R+ and R- is the input wire.
	Control power output (CTRL 12V)	Controls 12 VDC power output. It is to control the on-off alarm relay output.
	12V power output port	Provides power to external devices such as camera and alarm device. Note the supplying power shall be below 1A.
		Ground.
8	Network port	Connects to Ethernet port.
9	RS-232 debug COM.	It is for general COM debug to configure IP address or transfer transparent COM data.

No.	Port Name	Function
10	USB port	Connects to the external devices such as keyboard, mouse, and USB storage device.
11	VGA video output	Outputs analog video signal. It can connect to the monitor to view analog video.
10	Video input port	Connect to analog camera to input video signal.
11	Network port	Connects to Ethernet port.
12	eSATA port	External SATA port which connects to the device with SATA port. Perform the jumper configuration when connecting HDD.
13	HDMI port	High definition audio and video signal output port. It outputs the same video source as VGA. It supports 4K resolution output and supports mouse operation and control. Note when the HDMI output resolution is 4K, the VGA output stops.
14	Power button	Turns on/off the Device.
15	Power input port	Inputs power.
16	GND	Ground.

3.2.8 DH-XVR1Bxx-I/DH-XVR1BxxH-I

Figure 3-19 Rear panel

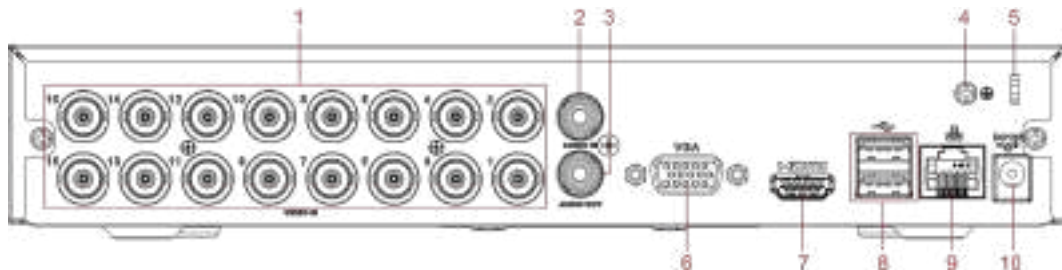

Table 3-18 Rear panel description

No.	Port Name	Function
1	Video input port	Connect to analog camera to input video signal.
2	Audio input port	Receives the analog audio signal output from the devices such as microphone.
3	Audio output port	Outputs the analog audio signal to the devices such as the sound box.
4	GND	Ground.
5	Power cable fastener	Use clamp to secure the power cable on the DVR in case there is any loss.
6	VGA video output	Outputs analog video signal. It can connect to the monitor to view analog video.

No.	Port Name	Function
7	HDMI port	High definition audio and video signal output port. It outputs the same video source as VGA. It supports 4K resolution output and supports mouse operation and control. Note when the HDMI output resolution is 4K, the VGA output stops.
8	USB port	Connects to the external devices such as keyboard, mouse, and USB storage device.
9	Network port	Connects to Ethernet port.
10	Power input port	Inputs power.

3.2.9 DH-XVR51xxC-I3/DH-XVR51xxC-4KL-I3

Figure 3-20 Rear panel

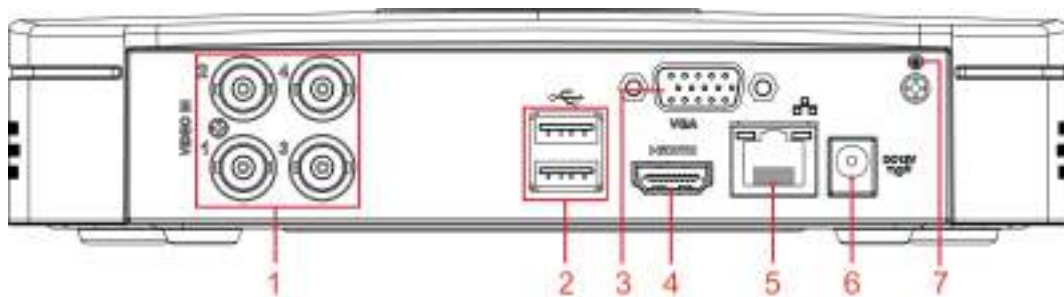

Table 3-19 Rear panel description

No.	Port Name	Function
1	Video input port	Connects to analog camera to input video signal.
2	USB port	Connects to external devices such as USB storage device, keyboard and mouse.
3	VGA port	Outputs analog video data to the connected display with VGA port.
4	HDMI port	High definition audio and video signal output port. The port outputs the uncompressed high definition video and multi-channel audio data to the connected display with HDMI port.
5	Network port	Connects to Ethernet port.
6	Power input port	Inputs 12 VDC power.
7	⊕	Ground terminal.

3.3 Remote Control Operations



Note the remote control is not our standard accessory and might not be included in the accessory bag. It is supplied dependent on the model you purchased.

Figure 3-21 Remote control

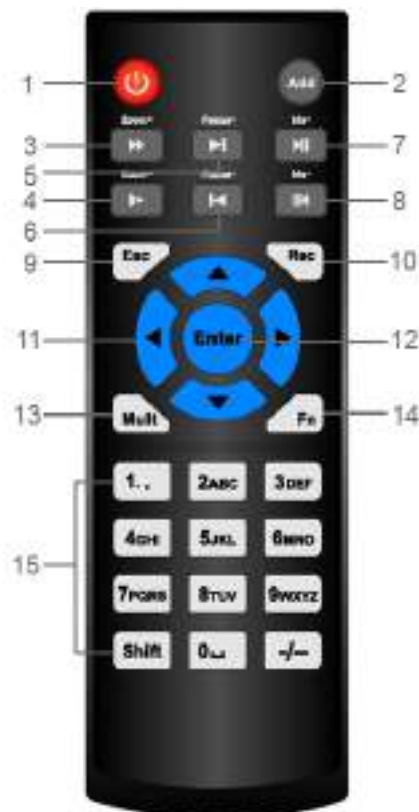

Table 3-20 Remote control description

No.	Name	Function
1	Power button	Press this button to boot up or shut down the device.
2	Address	Press this button to input device serial number, so that you can control the Device.
3	Forward	Multi-step forward speed and normal speed playback.
4	Slow motion	Multi-step slow motion speed or normal playback.
5	Next record	In playback state, press this button to play back the next video.
6	Previous record	In playback state, press this button to play back the previous video.
7	Play/Pause	<ul style="list-style-type: none"> ● In normal playback state, press this button to pause playback. ● In pause state, press this button to resume to normal playback. ● In live view window page, press this button to enter video search menu.
8	Reverse/pause	In the reverse playback state, press this button to pause reverse playback. In the reverse playback pause state, press this button to resume to playback reversing state.
9	Esc.	Go back to previous menu or cancel current operation (close front page or control).

No.	Name	Function
10	Record	<ul style="list-style-type: none"> Start or stop record manually. In record page, use the direction buttons to select the channel that you want to record. Press this button for at least 1.5 seconds, and the manual record page will be displayed.
11	Direction keys	Switch between current activated controls by going left or right. In playback state, the keys control the playback progress bar. Aux function (such as operating the PTZ menu).
12	Enter/menu key	<ul style="list-style-type: none"> Confirms an operation. Go to the OK button. Go to the menu.
13	Multiple-window switch	Switch between multiple-window and one-window.
14	Fn	<ul style="list-style-type: none"> In single-channel monitoring mode, press this button to display the PTZ control and color setting functions. Switch the PTZ control menu in PTZ control page. In motion detection page, press this button with direction keys to complete setup. In text mode, press and hold this button to delete the last character. To use the clearing function: Long press this button for 1.5 seconds. In HDD menu, switch HDD recording time and other information as indicated in the pop-up message.
15	Alphanumeric keys	<ul style="list-style-type: none"> Input password, numbers. Switch channel. Press Shift to switch the input method.







3.4 Mouse Operations



The operations are based on the considerations for right-handed users.

Table 3-21 Mouse operations

Operation	Function
Click left mouse button	Password input dialogue box pops up if you have not logged in yet. In live view window page, you can go to the main menu.
	When you have selected one menu item, click it to view menu content.
	Implement the control operation.
	Modify checkbox or motion detection status.
	Click combo box to pop up drop-down list.
	In text box, click the corresponding button on the panel to enter a numeral or English character (small/capitalized).

Operation	Function
	<ul style="list-style-type: none"> <li data-bbox="533 264 1444 353">● In English input mode: Click  to enter a backspace and click  to delete the previous character.  <ul style="list-style-type: none"> <li data-bbox="533 555 1444 645">● In numeral input mode: Click  to clear and click  to delete the previous character. 
Double-click left mouse button	Implement special control operations such as double-click one item in the file list to play back the video. In multiple-window mode, double-click one channel to view in full-window. Double-click current video again to go back to previous multiple-window mode.
Right-click	Right-click in live view window page, the shortcut menu is displayed. For different series product, the shortcut menu may vary. Exit current menu without saving the modification.
Click scroll wheel button	In numeral input box: Increase or decrease numeral value. Switch the items in the combo box. Page up or page down.
Point to select and move	Select current control and move it.
Dragging a selection box with left mouse button	Select motion detection zone. Select privacy mask zone.

4 Connection

This chapter introduces the typical connection diagrams and ports connections.

4.1 Typical Connection Diagram



The following figure is for reference only and might differ from the actual product.

Figure 4-1 Connection diagram

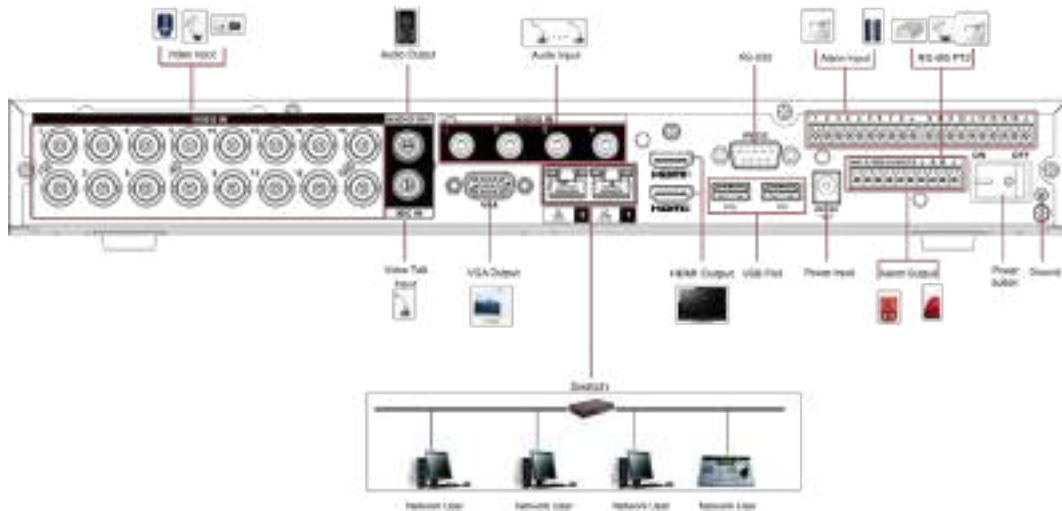

4.2 Connecting to Video and Audio Input and Output

4.2.1 Video Input

The video input port is BNC. The input video format includes: PAL/NTSC BNC (1.0 V_{P-P}, 75 Ω).

The video signal should comply with your national standards.

The input video signal shall have high SNR, low distortion; low interference, natural color, and suitable lightness.

Guarantee the stability and reliability of the camera signal

The camera shall be installed in a cool, dry place away from the conditions such as direct sunlight, inflammable, and explosive substances.

The camera and the DVR should have the same grounding to ensure the normal operation of the camera.

Guarantee stability and reliability of the transmission line

Use high quality, sound shielded BNC. Select suitable BNC model according to the transmission distance.

If the distance is too long, you should use twisted pair cable, and you can add video compensation devices or use optical fiber to ensure video quality.

You should keep the video signal away from the strong electromagnetic interference, especially the high tension current.

Keep connection lugs in well contact

The signal line and shielded wire should be fixed firmly and in well connection. Avoid dry joint, lap welding, and oxidation.

4.2.2 Video Output

Video output includes a BNC (PAL/NTSC 1.0 V_{p-p}, 75 Ω) output, a VGA output, and HDMI output. System supports BNC, VGA and HDMI output at the same time.

When you are using pc-type monitor to replace the monitor, pay attention to the following points:

- To defer aging, do not allow the pc monitor to run for a long time.
- Regular demagnetization will keep device maintain proper status.
- Keep it away from strong electromagnetic interference devices.

Using TV as video output device is not a reliable substitution method. You also need to reduce the working hour and control the interference from power supply and other devices. The low quality TV may result in device damage.

4.2.3 Audio Input

This series of products audio input port adopt BNC port.

Due to high impedance of audio input, use active sound pick-up.

Audio transmission is similar to video transmission. Try to avoid interference, dry joint, loose contact and it shall be away from high tension current.

4.2.4 Audio Output

The audio output signal parameter is usually over 200 mv 1 KΩ (BNC or RCA). It can directly connect to low impedance earphone, active sound box or amplifier-drive audio output device.

If the sound box and the pick-up cannot be separated spatially, it is easy to arouse squeaking. In this case you can adopt the following measures:

- Use better sound pick-up with better directing property.
- Reduce the volume of the sound box.
- Using more sound-absorbing materials in decoration can reduce voice echo and improve acoustics environment.
- Adjust the layout of speaker and pickup to reduce squeaking.

4.3 Connecting to Alarm Input and Output

Read the followings before connecting.

Alarm input

- Make sure alarm input mode is grounding alarm input.
- Grounding signal is needed for alarm input.
- Alarm input needs the low level voltage signal.
- Alarm input mode can be either NC (Normally Closed) or NO (Normally Open).
- When you are connecting two DVRs or you are connecting one DVR and one other device, use a relay to separate them.

Alarm output

The alarm output port should not be connected to high power load directly (It shall be less than 1A) to avoid high current which might result in relay damage. Use the contactor to realize the connection between the alarm output port and the load. The next device connected to the port must meet the fire enclosure requirements.

How to connect PTZ decoder

- Ensure the decoder has the same grounding with DVR; otherwise the PTZ might not be controlled. Shielded twisted wire is recommended and the shielded layer is used to connect to the grounding.
- Avoid high voltage. Ensure proper wiring and some thunder protection measures.
- For too long signal wires, 120 Ω should be parallel connected between A, B lines on the far end to reduce reflection and guarantee the signal quality.
- "485 A, B" of DVR cannot parallel connect with "485 port" of other device.
- The voltage between of A, B lines of the decoder should be less than 5 V.

Make sure the front-end device has soundly earthed

Improper grounding might result in chip damage.

4.3.1 Introducing Alarm Port



The alarm input ports are dependent on the model you purchased.

Figure 4-2 Alarm ports

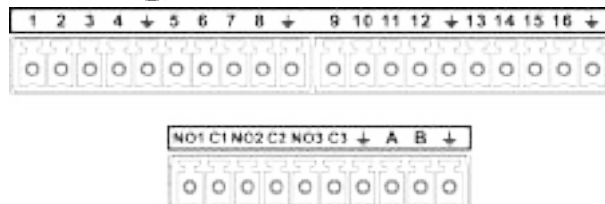

Table 4-1 Alarm port description

Icon	Description
1, 2, 3, 4, 5, 6, 7, 8, 9, 10, 11, 12, 13, 14, 15, 16	ALARM 1 to ALARM 16. The alarm becomes active in low voltage.

Icon	Description
NO1 C1, NO2 C2, NO3 C3	There are four groups of normally open activation output (on/off button).
	Ground cable.
485 A/B	485 communication port. They are used to control devices such as decoder. 120 Ω should be parallel connected between A, B lines if there are too many PTZ decoders.

4.3.2 Alarm Input

Refer to the following figure for more information.

- Grounding alarm inputs which includes NO (Normally Open) and NC (Normally Closed) type.
- Parallel connect COM end and GND end of the alarm detector (Provide external power to the alarm detector).
- Parallel connect the Ground of the DVR and the ground of the alarm detector.
- Connect the NC port of the alarm sensor to the DVR alarm input (ALARM).
- Use the same ground with that of DVR if you use external power to the alarm device.

Figure 4-3 Alarm input

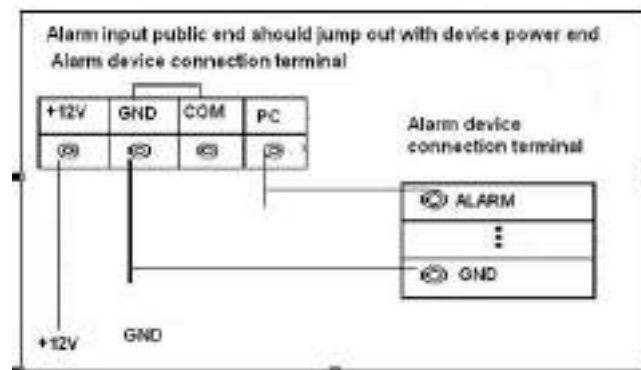

4.3.3 Alarm Output

- Provide external power to external alarm device.
- To avoid overloading, read the following relay parameters table carefully.
- RS-485 A/B cable is for the A/B cable of the PTZ decoder.

4.3.4 Alarm Output Relay Parameters



Refer to the actual product for relay model information.

Table 4-2 Alarm output relay parameters

Model		HFD23/005-1ZS	HRB1-S-DC5V
Material of the touch		AgNi+ gold-plating	AuAg10/AgNi10/CuNi30
Rating (Resistance Load)	30 VDC 1 A/125 VAC 0.5 A	24 VDC 1 A/125 VAC 2 A	24 VDC 1 A/125 VAC 2 A
	62.5 VA/30 W	250 VA/48 W	250 VA/48W
	125 VAC/60 VDC	125 VAC/60 VDC	125 VAC/60 VDC
	2 A	2 A	2 A
Insulation	400 VAC 1 minute	500 VAC 1 minute	500 VAC 1 minute
	1000 VAC 1 minute	1000 VAC 1 minute	1000 VAC 1 minute
Turn-on Time		5 ms max	5 ms max
Turn-off Time		5 ms max	5 ms max
Longevity	1 × 10 ⁷ times (300 times/MIN)	5 × 10 ⁶ times (300 times/MIN)	5 × 10 ⁶ times (300 times/MIN)
	1 × 10 ⁵ times (30 times/MIN)	2.5 × 10 ⁴ times (30 times/MIN)	2.5 × 10 ⁴ times (30 times/MIN)
Working Temperature		-30 °C to +70 °C	-40 °C to +70 °C

5 Local Configurations

Read the following notes prior to using the Device.



- The figures in the Manual are used for introducing the operations and only for reference. The actual interface might be different dependent on the model you purchased.
- The Manual is a general document for introducing the product, so there might be some functions described for the Device in the Manual not apply to the model you purchased.
- Conventions for mouse operations on a menu.
 - ◇ Click: On the menu, click the mouse once on an option to enter the option setting.
 - ◇ Right-click: On any page, right-click the mouse once to return to the previous level. For details about mouse operations, see "3.4 Mouse Operations".

5.1 Initial Settings

5.1.1 Booting up



- Ensure the input voltage corresponds to the power requirement of the Device. Power on the Device after the power cable is properly connected.
- To protect the Device, connect the Device with the power cable first, and then connect to the power source.
- To ensure the stable work of the Device and the external devices connected to the Device and to prolong the HDD life, it is recommended to refer to the national related standard to use the power source that provides stable voltage with less interference from ripples. UPS power source is recommended.

Step 1 Connect the Device to the monitor.

Step 2 Plug in the power cable to the Device.

Step 3 Press the power button to turn on the Device. The power indicator light is on.

On the connected monitor, the live view screen is displayed by default. If you turn on the Device during the time period that is configured for recording, the system starts recording after it is turned on, and you will see the icon indicating recording status is working in the specific channels.

5.1.2 Initializing the Device

When booting up for the first time, you need to configure the password information for **admin** (by default).



To secure the Device, we strongly recommend you properly keep the password for admin and modify it regularly.

Step 1 Turn on the Device.

Figure 5-1 Location, language and video standard

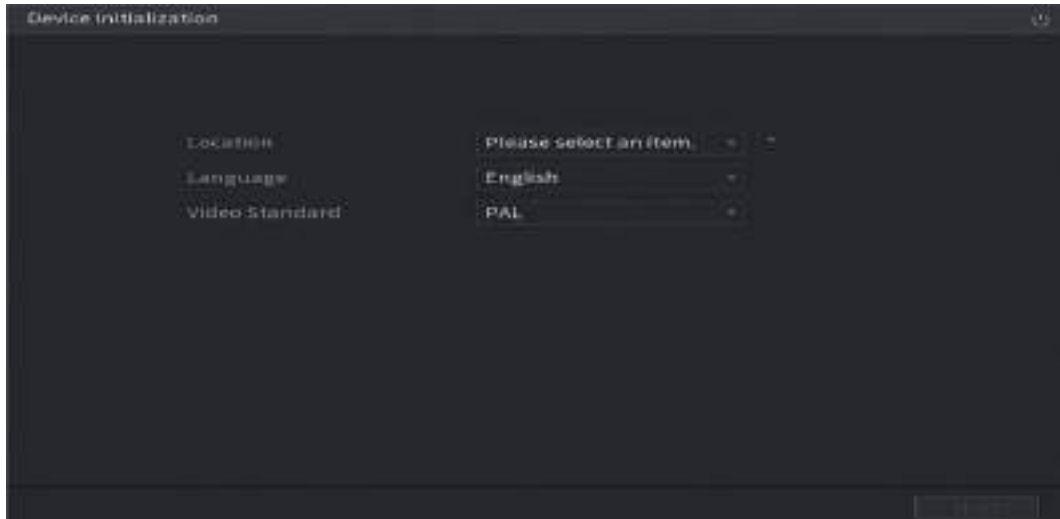

Step 2 Select your location from the drop-down list, then language and video standard will match your location automatically. You can change the language and video standard manually.

Step 3 Click **Next**.

Figure 5-2 License agreement

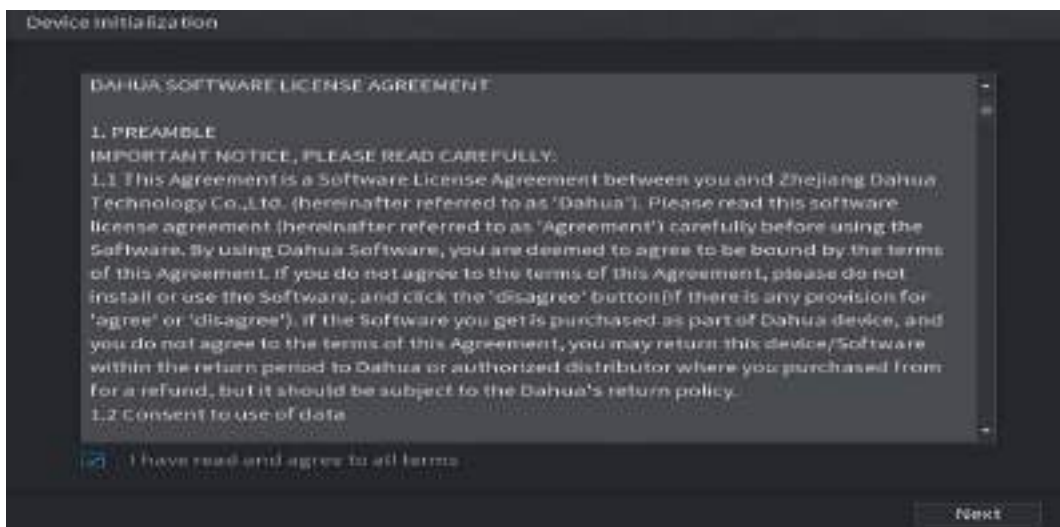

Step 4 Select the checkbox that **I have read and agree to all terms**, and then click **Next**.

Figure 5-3 Time

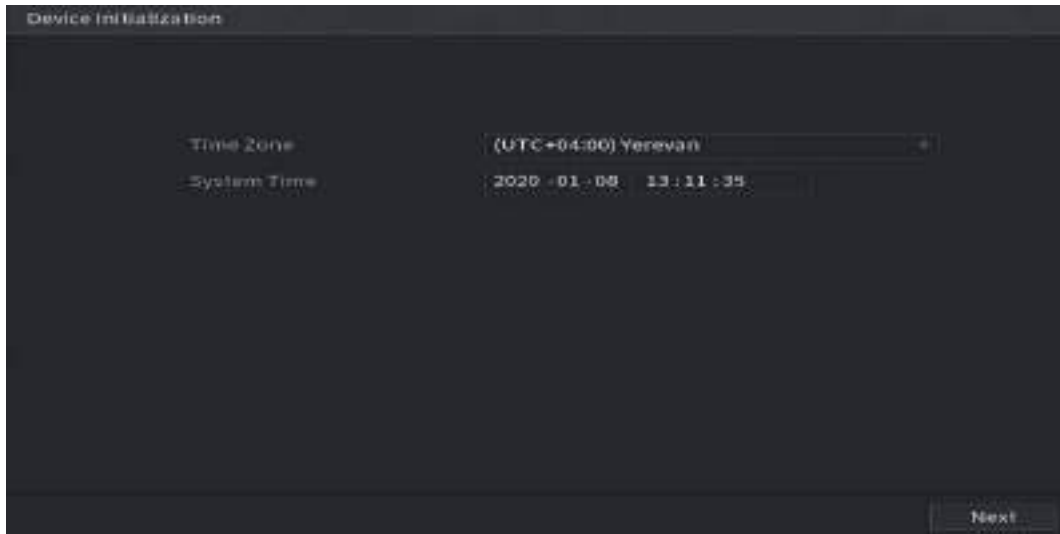

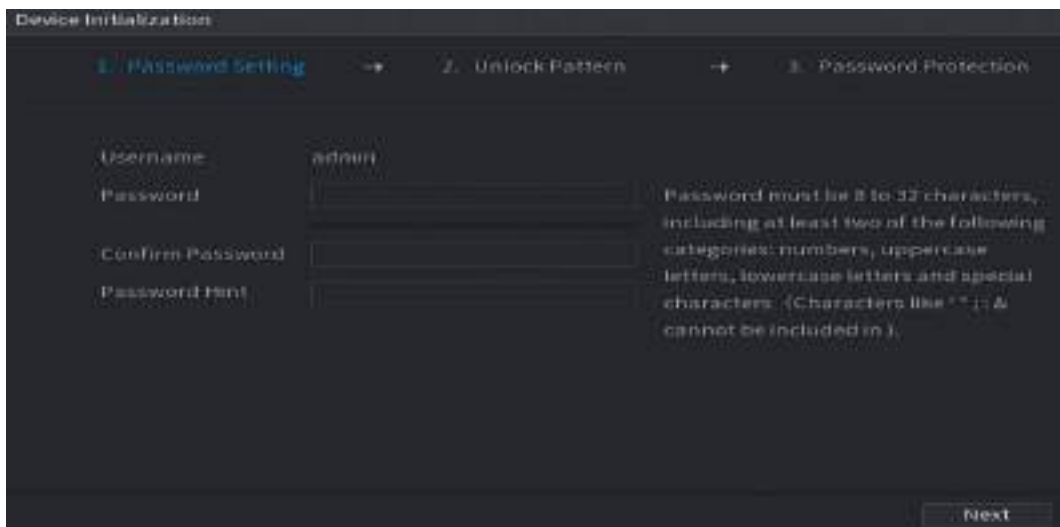

Step 5 Select system zone, configure system time, and then click **Next**.

Figure 5-4 Enter password



Step 6 Configure the password information for admin.

Table 5-1 Password information

Parameter	Description
User	By default, the user is admin .
Password	In the Password box, enter the password for admin.
Confirm Password	The new password can be set from 8 characters through 32 characters and contains at least two types from number, letter and special characters (excluding "", "", ";", ":" and "&").
Prompt Hint	<p>In the Prompt Hint box, enter the information that can remind you of the password.</p> <p></p> <p>On the login page, click , the prompt will display to help you find back the password.</p>

Step 7 Click **Next**.

Figure 5-5 Unlock pattern

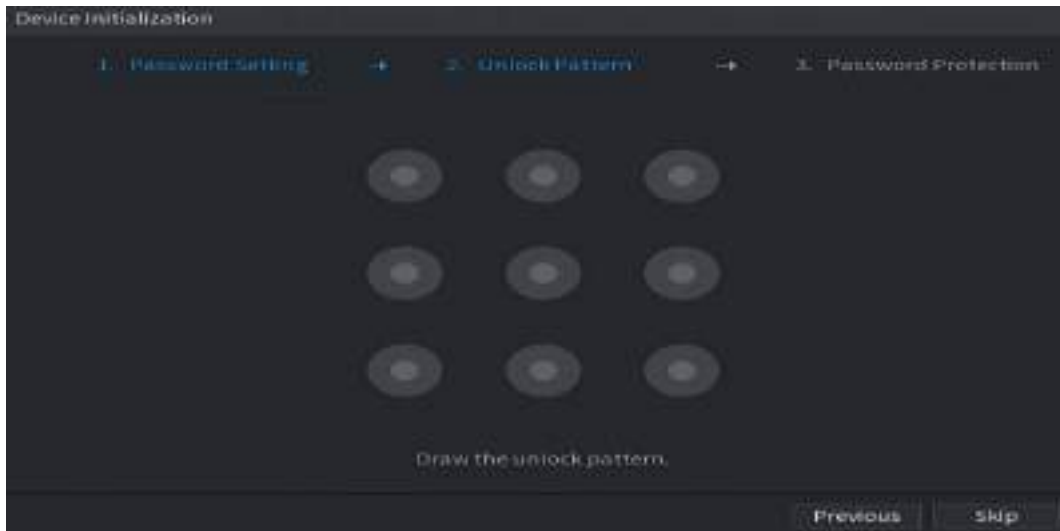

Step 8 Draw an unlock pattern.



- The pattern that you want to set must cross at least four points.
- If you do not want to configure the unlock pattern, click **Skip**.
- Once you have configured the unlock pattern, the system will require the unlock pattern as the default login method. If you skip this setting, enter the password for login.

Figure 5-6 Password protection

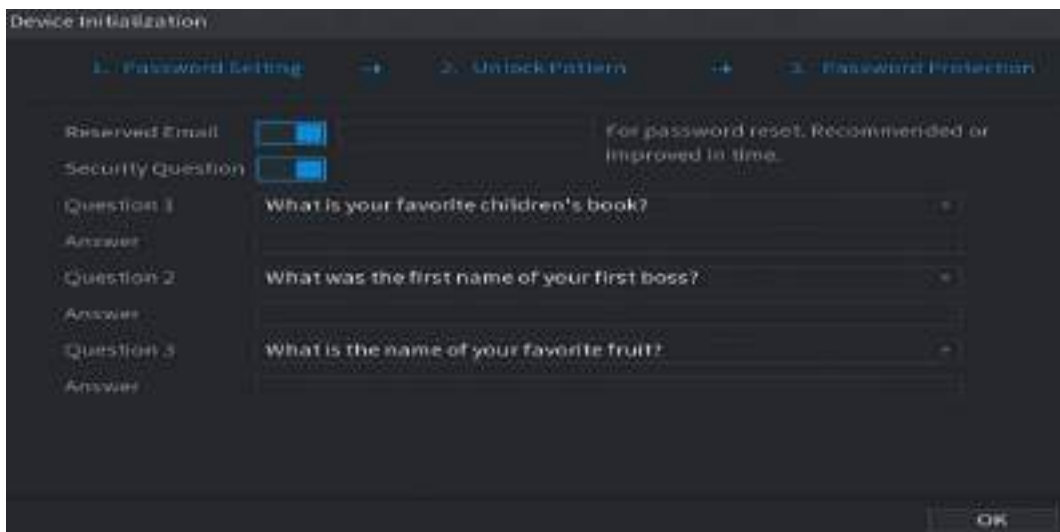

Step 9 Configure the protection parameters for password.

After configuration, if you forget the password for admin user, you can reset the password through the reserved email address or security questions. For details about resetting the password, see "5.1.3 Resetting Password".

If you do not want to configure the settings, disable the email address and security questions functions on the page.

Table 5-2 Password protection parameters

Password Protection Mode	Description
Reserved Email	Enter the reserved email address. In the Reserved Email box, enter an email address for password reset. If you forget the password, enter the security code that you will get from this reserved email address to reset the password of admin.
Security Questions	Configure the security questions and answers. If you forget the password, enter the answers to the questions can make you reset the password.
 <p>If you want to configure the email or security questions function later or you want to change the configurations, select Main Menu > ACCOUNT > Password Reset.</p>	

Step 10 Click **OK** to complete the settings.

Step 11 Select **I have read and agree to all terms** checkbox.

Step 12 Click **Next**.

The **Startup Wizard** page is displayed. For details about quick settings during startup, see "5.1.4 Setting Up with the Startup Wizard".

5.1.3 Resetting Password

You can reset the password by the following methods when you forget the password for admin account.

- If the password reset function is enabled, you can use mobile phone to scan the QR code to reset the password. For details, see "5.1.3.2 Resetting Password on Local Interface".
- If the password reset function is disabled, there are two situations:
 - ◇ If you configured security questions, you can find back the password by the security questions.
 - ◇ If you did not configure the security questions, you can only use the reset button on the mainboard to restore the Device to factory default. For details, see "5.1.3.3 Using Reset Button on the Mainboard".



Not all models are provided with reset button.

5.1.3.1 Enabling Password Reset Function

Step 1 Select **Main Menu > Account > Password Reset**.

Figure 5-7 Password reset



Step 2 Enable the Password Reset function.



This function is enabled by default.

Step 3 Click **Apply** to save the settings.

When Password reset function is disabled, you can retrieve password through following ways:

- You can retrieve password through resetting password on local interface or using Reset button on the mainboard when the device supports Reset button.
- You can only retrieve password through resetting password on local interface (make sure that security questions are preset) when the device does not support Reset button.

5.1.3.2 Resetting Password on Local Interface

Step 1 Enter the login page.

- If you have configured unlock pattern, the unlock pattern login page is displayed. Click **Forgot Pattern**, the password login page is displayed.
- If you did not configure unlock pattern, the password login page is displayed. Click  to display the password with plaintext.



To log in from other user account, on the unlock pattern login page, click **Switch User**; or on the password login page, in the **User Name** list, select other users to login.

Figure 5-8 Login (1)

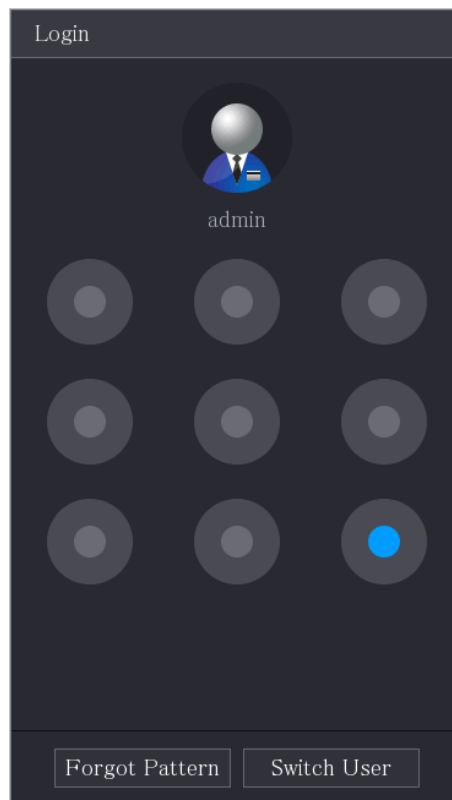
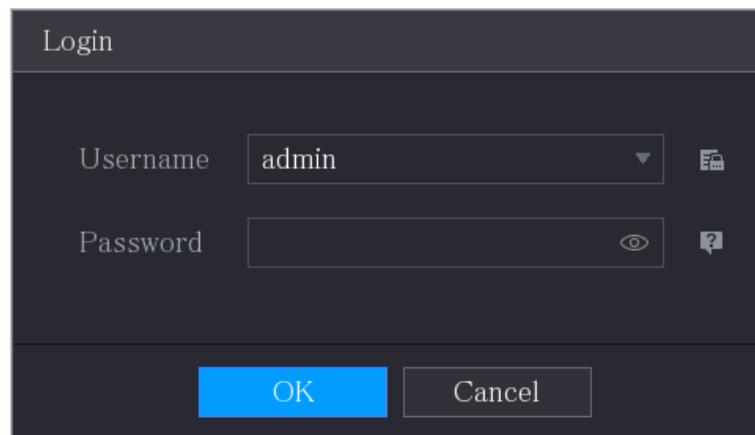

Figure 5-9 Login (2)



Step 2

Click

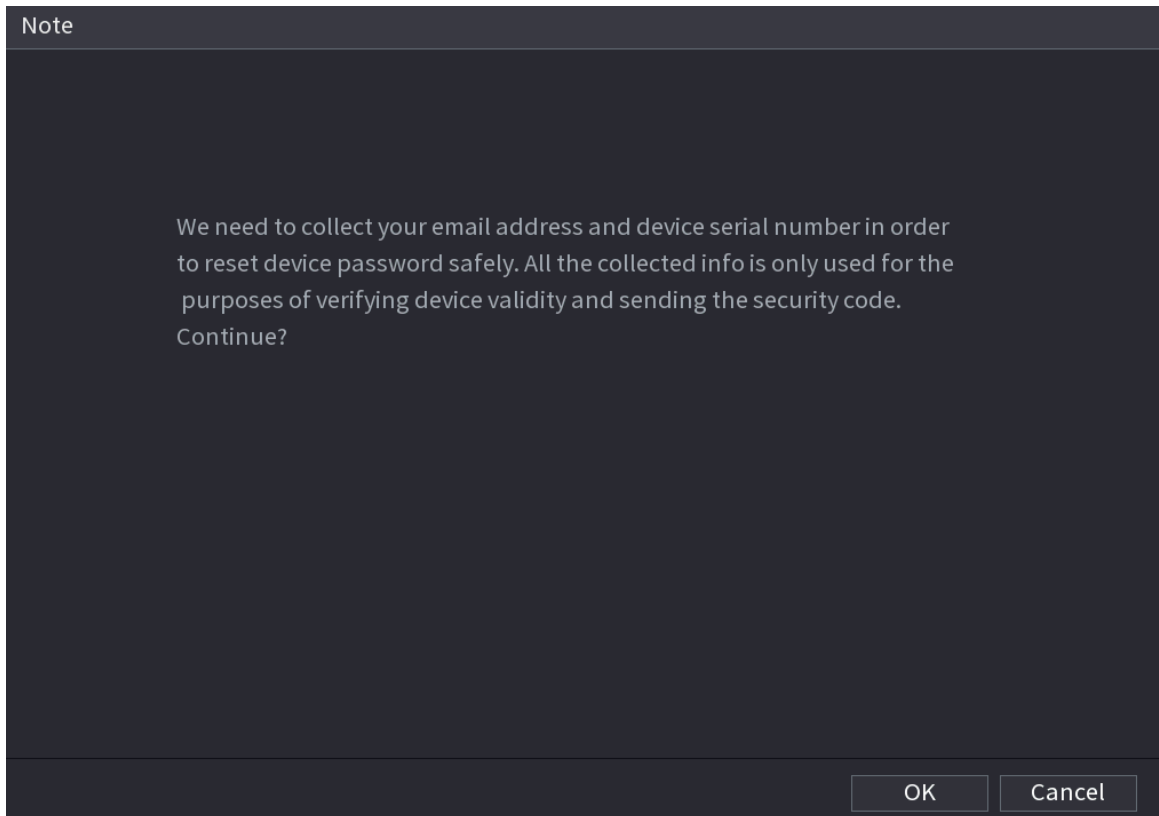

- If you have set the reserved email address, the **Prompt** message page is displayed.
- If you did not set the reserved email address, the email entering page is displayed. See Step 3. Enter the email address, and then click **Next**, the **Prompt** message page is displayed.

Figure 5-10 Note



Step 3 Click OK.



After clicking OK, the system will collect your information for password reset, and the information includes but not limited to email address, and device serial number. Read the prompt carefully before clicking OK.

Figure 5-11 Reset mode (email)

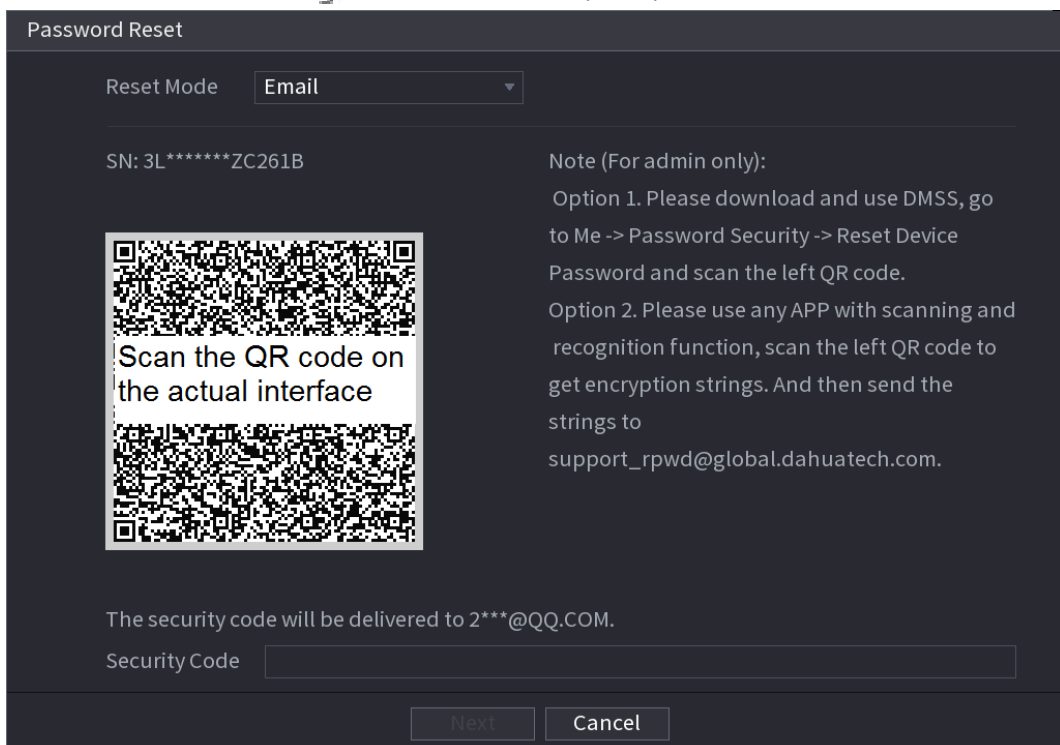
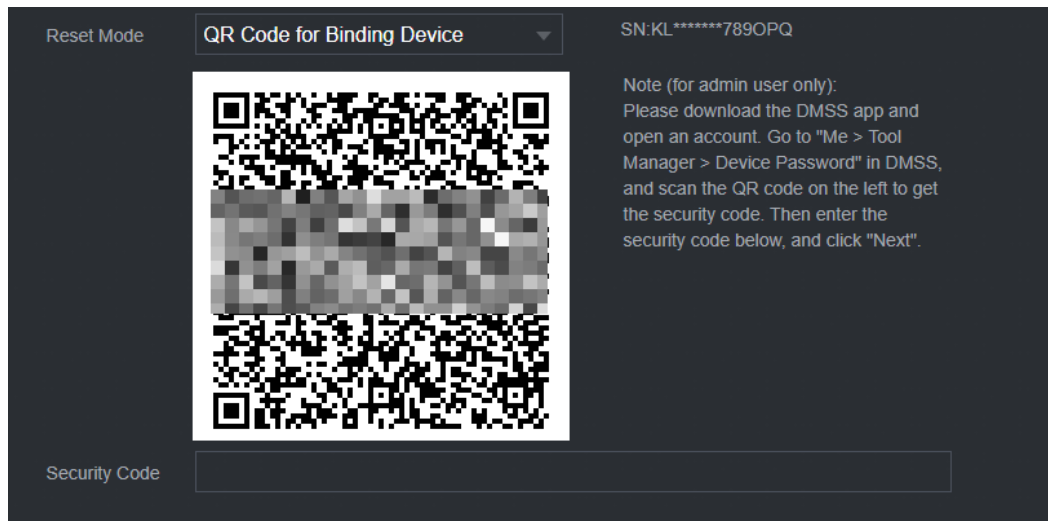

Figure 5-12 Reset mode (app)



Step 4 Reset the password.

- QR code
Follow the on-screen instructions to get the security code in your reserved email address. In the **Security Code** box, enter the security code.



- You can get the security code twice by scanning the same QR code. If you need to get the security code once again, refresh the page.
- Use the security code received in your email box to reset the password within 24 hours; otherwise the security code becomes invalid.
- App
Select **QR Code for Binding Device** as **Reset Mode**, and then follow the on-screen instructions to get the security code on your DMSS app. In the **Security Code** box, enter the security code.
- Security questions
 - 1) For **Reset Mode**, select **Security Questions**.



If you did not configure the security questions before, in the **Reset Type** list, there will be no **Security Questions**.

- 2) In the **Answer** box, enter the correct answers.

Figure 5-13 Security questions

Password Reset

Reset Mode: Security Question

Question 1: What is your favorite children's book?
Answer: [Text Box]

Question 2: What was the first name of your first boss?
Answer: [Text Box]

Question 3: What is the name of your favorite fruit?
Answer: [Text Box]

Next Cancel

Step 5 Click **Next**.

Figure 5-14 New password

Password Reset

Reset the password of (admin)

New Password: [Text Box]

Confirm Password: [Text Box]

Password must be 8 to 32 characters, including at least two of the following categories: numbers, uppercase letters, lowercase letters and special characters (Characters like ' " ; & cannot be included in).

OK Cancel

Step 6 In the **New Password** box, enter the new password and enter it again in the **Confirm Password** box.

Step 7 Click **Save**. The password resetting is started.

After resetting is completed, a pop-up message is displayed.

Step 8 Click **OK**.

A pop-up message is displayed asking if you want to sync the password with the remote devices.

- Click **Cancel**, the resetting is finished.
- Click **OK**, the Sync Info page is displayed.

Figure 5-15 Sync password

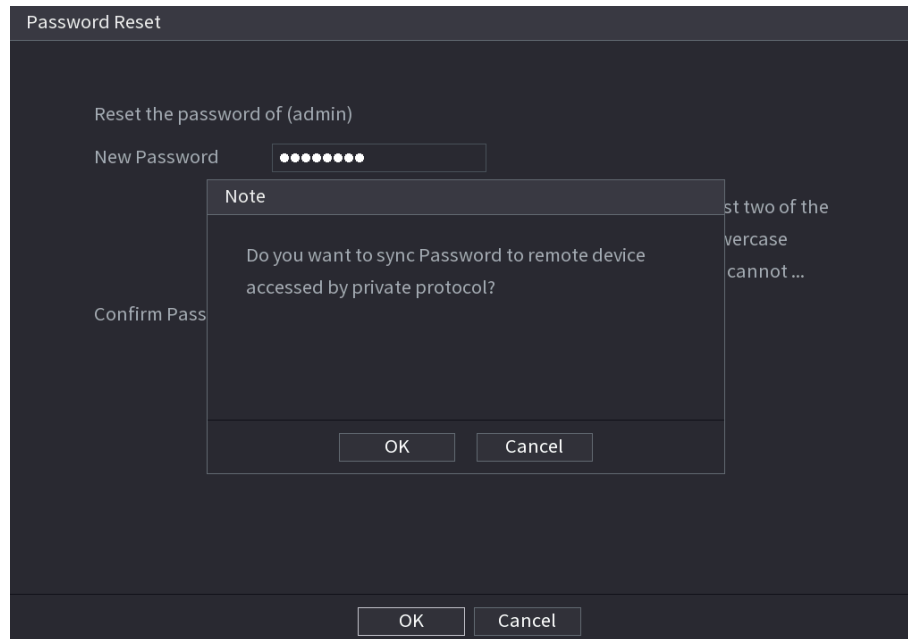

This message appears only when there are digital channels instead of only analog channels.

Figure 5-16 Sync info

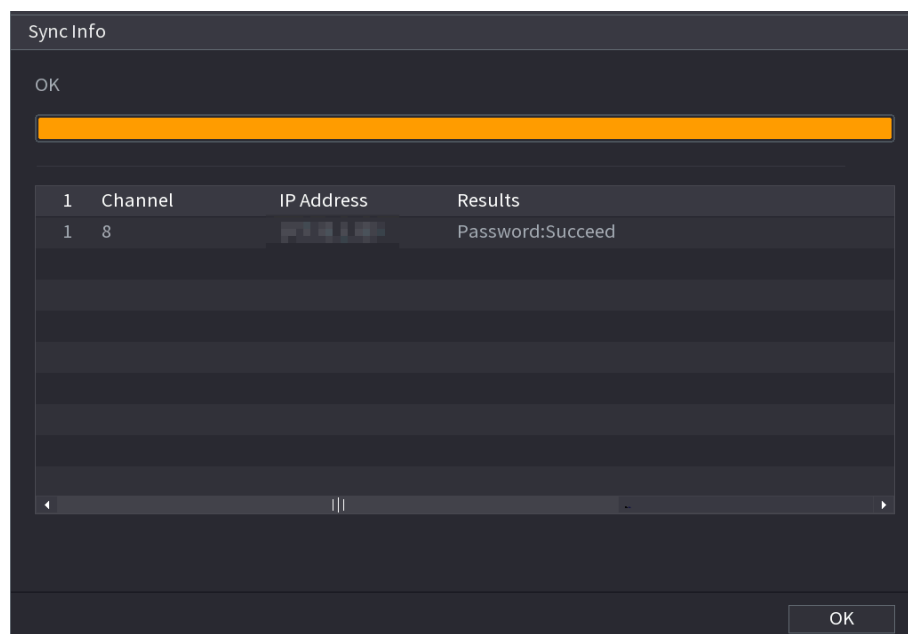

5.1.3.3 Using Reset Button on the Mainboard

You can always use the reset button on the mainboard to reset the Device to the factory default.



Not all models are provided with reset button.

Step 1 Disconnect the Device from power source, and then remove the cover panel. For details about removing the cover panel, see "2.2 Installing HDD".

Step 2 Find the reset button on the mainboard, and then press and hold the reset button for 5 seconds to 10 seconds.

Figure 5-17 Reset button



Step 3 Reboot the Device.

After the Device is rebooted, the settings have been restored to the factory default. You can start resetting the password.

5.1.4 Setting Up with the Startup Wizard

5.1.4.1 Entering Startup Wizard

The Startup Wizard helps you configure the basic settings to set up the Device.

After you have initialized the Device, the **Startup Wizard** page is displayed.

Figure 5-18 Startup wizard

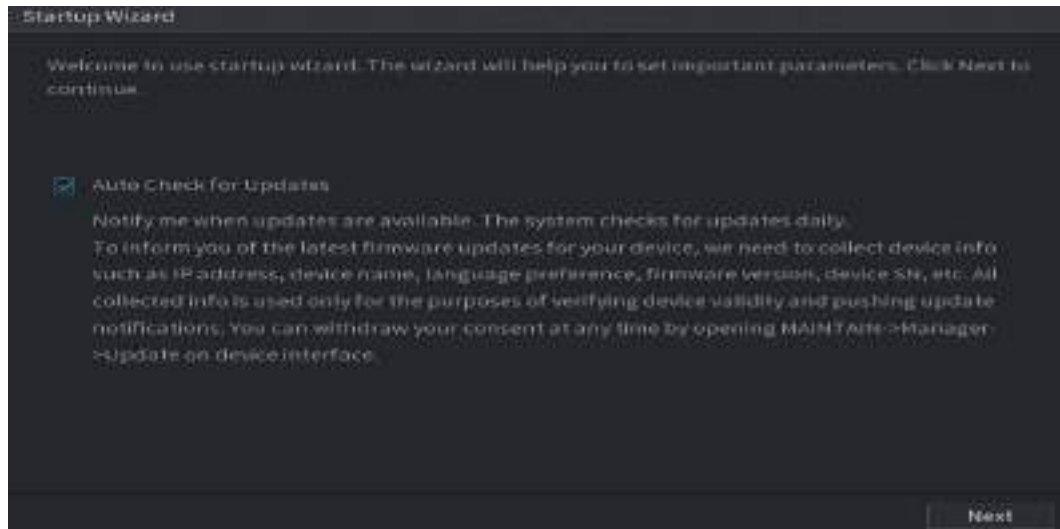

- If you select the **Auto-check for updates** checkbox, the system will notify you automatically when updates are available.
- After the auto-check function is enabled, to notify you to update timely, the system will collect the information such as IP address, device name, firmware version, and device serial number. The collected information is only used to verify the legality of the Device and push upgrade notices.
- If you clear the **Auto-check for updates** checkbox, the system will not perform automatic checks.

5.1.4.2 Configuring General Settings

You can configure the general settings for the Device such as Device name, language, and settings for instant playback.

You can also configure general settings by selecting **Main Menu > SYSTEM > General > Basic**.

Step 1 On the **Startup Wizard** page, click **Next**.

Figure 5-19 Basic

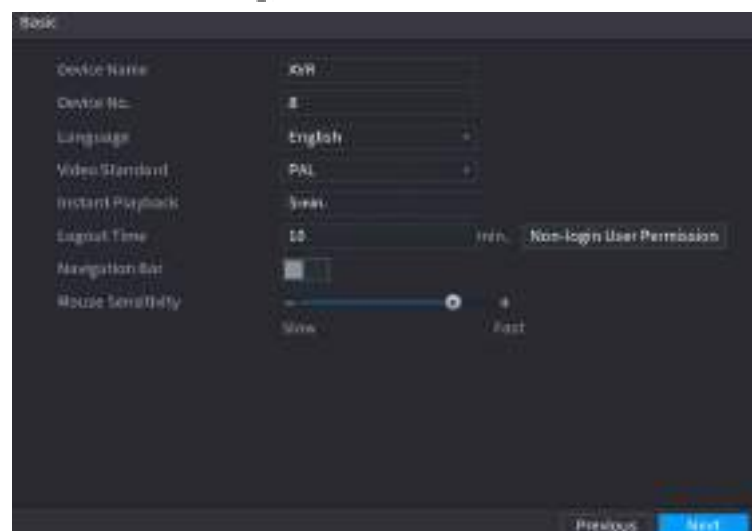

Step 2 Configure the basic settings parameters.

Table 5-3 Basic settings

Parameter	Description
Device Name	In the Device Name box, enter the Device name.
Device No.	In the Device No. box, enter a number for the Device.
Language	In the Language list, select a language for the Device system.
Video Standard	In the Video Standard list, select PAL or NTSC according to your actual situation.
Instant Playback	In the Instant Playback box, enter the time length for playing back the recorded video. On the live view control bar, click the instant playback button to play back the recorded video within the configured time.
Logout Time	In the Logout Time box, enter the standby time for the Device. The Device automatically logs out when it is not working for the configured time period. You need to log in to the Device again. The value ranges from 0 to 60. 0 indicates there is not standby time for the Device. Click Monitor Channel(s) when logout . You can select the channels that you want to continue monitoring when you logged out.
Navigation Bar	Enable the navigation bar. When you click on the live view screen, the navigation bar is displayed.
Mouse Pointer Speed	Adjust the speed of double-click by moving the slider. The bigger the value is, the faster the double-clicking speed must be.

5.1.4.3 Configuring Date and Time Settings

You can configure the system time, choose the time zone, set the daylight saving time, and enable the NTP server.



You can also configure date and time settings by selecting **Main Menu > SYSTEM > General > Date & Time**.

Step 1 After you have configured the general settings, on the **General** page, click **Next**.

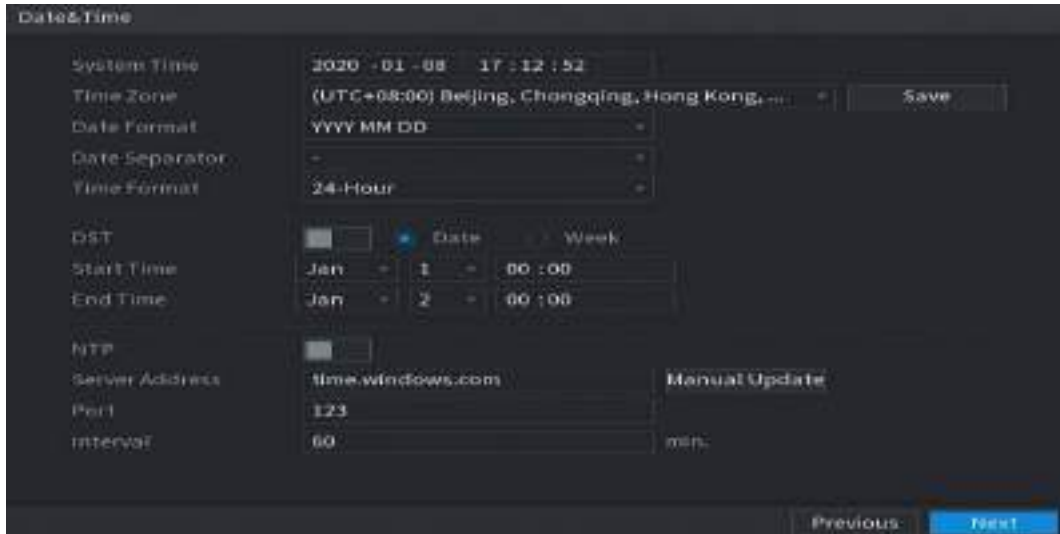
Figure 5-20 Date&Time



Step 2 Configure the settings for date and time parameters.

Parameter	Description
System Time	<p>In the System Time box, enter time for the system. Click the time zone list, you can select a time zone for the system, and the time in adjust automatically.</p>  <p>Do not change the system time randomly; otherwise the recorded video cannot be searched. It is recommended to avoid the recoding period or stop recording first before you change the system time.</p>
Time Zone	In the Time Zone list, select a time zone for the system.
Date Format	In the Date Format list, select a date format for the system.
Date Separator	In the Date Separator list, select a separator style for the date.
Time Format	In the Time Format list, select 12-HOUR or 24-HOUR for the time display style.
DST	Enable the Daylight Saving Time function. Click Week or click Date .
Start Time	Configure the start time and end time for the DST.
End Time	
NTP	<p>Enable the NTP function to sync the Device time with the NTP server.</p>  <p>If NTP is enabled, device time will be automatically synchronized with server.</p>
Server Address	<p>In the Server Address box, enter the IP address or domain name of the corresponding NTP server. Click Manual Update, the Device starts syncing with the server immediately.</p>
Port	The system supports TCP protocol only and the default setting is 123.

Parameter	Description
Interval	In the Interval box, enter the amount of time that you want the Device to sync time with the NTP server. The value ranges from 0 to 65535.

5.1.4.4 Configuring Network Settings

You can configure the basic network settings such as net mode, IP version, and IP address of the Device.

You can also configure network settings by selecting **Main Menu > NETWORK > TCP/IP**.

Step 1 After you have configured the date and time settings, on the **Date & Time** page, click **Next**.

Figure 5-21 TCP/IP

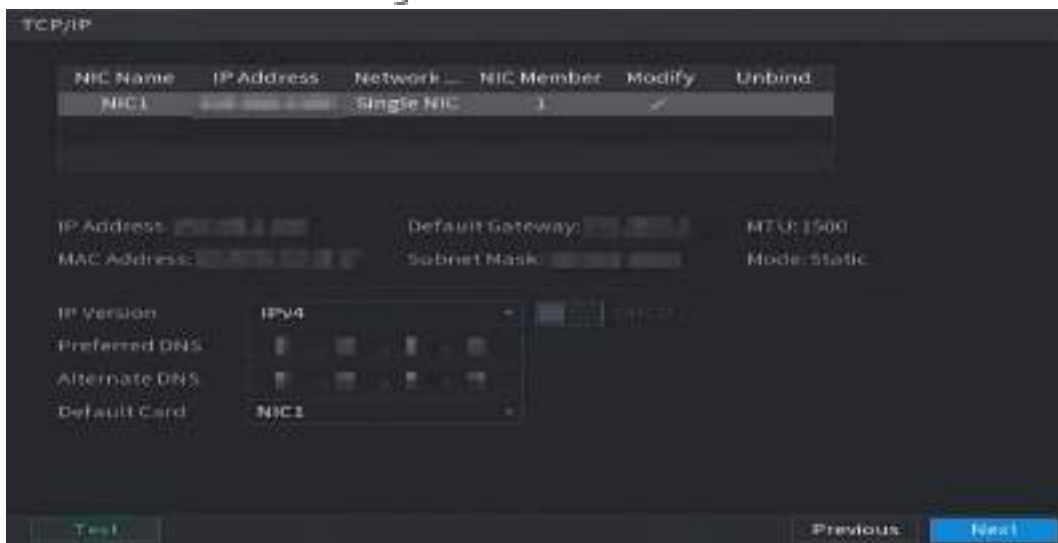

Step 2 Configure the settings for network parameters.

Table 5-4 Network parameters

Parameter	Description
IP Version	In the IP Version list, you can select IPv4 or IPv6 . Both versions are supported for access.
MAC Address	Displays the MAC address of the Device.
DHCP	<p>Enable the DHCP function. The IP address, subnet mask and default gateway are not available for configuration once DHCP is enabled.</p> <ul style="list-style-type: none"> ● If DHCP is effective, the obtained information will display in the IP Address box, Subnet Mask box and Default Gateway box. If not, all values show 0.0.0.0. ● If you want manually configure the IP information, disable the DHCP function first. ● If PPPoE connection is successful, the IP address, subnet mask, default gateway, and DHCP are not available for configuration.
IP Address	Enter the IP address and configure the corresponding subnet mask and default gateway.
Subnet Mask	
Default Gateway	
	IP address and default gateway must be in the same network segment.

Parameter	Description
DNS DHCP	Enable the DHCP function to get the DNS address from router.
Preferred DNS	In the Preferred DNS box, enter the IP address of DNS.
Alternate DNS	In the Alternate DNS box, enter the IP address of alternate DNS.
MTU	<p>In the MTU box, enter a value for network card. The value ranges from 1280 byte through 1500 byte. The default is 1500.</p> <p>The suggested MTU values are as below.</p> <ul style="list-style-type: none"> ● 1500: The biggest value of Ethernet information package. This value is typically selected if there is no PPPoE or VPN connection, and it is also the default value of some routers, network adapters and switches. ● 1492: Optimized value for PPPoE. ● 1468: Optimized value for DHCP. ● 1450: Optimized value for VPN.
Test	Click Test to test if the entered IP address and gateway are interworking.

5.1.4.5 Configuring P2P Settings

You can add the Device into your cell phone client or the platform to manage.

You can also configure P2P function by selecting **Main Menu > Network > P2P**.



Make sure the DVR is connected into the Internet, and if yes, in the **Status** box of the P2P page, it shows **Online**.

Step 1 After you have configured the network settings, on the **Network** page, click **Next**.

Figure 5-22 P2P



Step 2 Enable the P2P function.



After the P2P function is enabled and connected to the Internet, the system will collect your information for remote access, and the information includes but not limited to email address, MAC address, and device serial number.

You can start adding the device.

- Cell Phone Client: Use your mobile phone to scan the QR code to add the device into the Cell Phone Client, and then you can start accessing the Device.
- Platform: Obtain the Device SN by scanning the QR code. Go to the P2P management platform and add the Device SN into the platform. Then you can access and manage the device in the WAN. For details, refer to the P2P operation manual.



- You can also enter the QR code of Cell Phone Client and Device SN by clicking  on the upper-right corner of the pages after you have entered the Main Menu.
- If selection of this function is canceled, the **Note** page is displayed. Choose to enable it or not according to your actual need.

Figure 5-23 Note



To use this function, take adding device into Cell Phone Client as an example.

Adding Device into Cell Phone Client

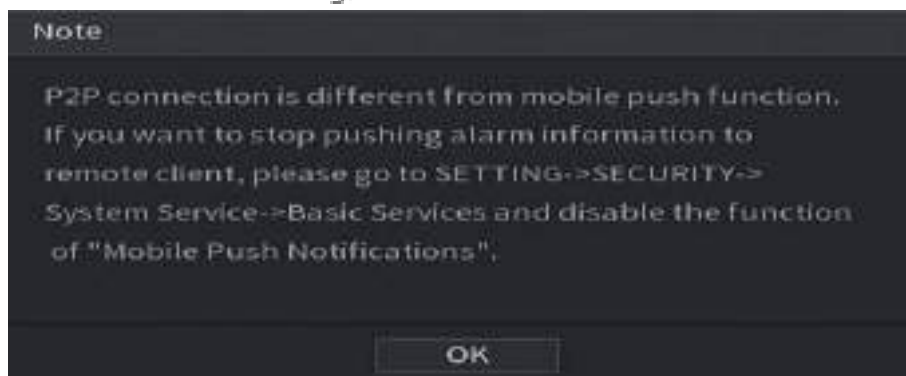
Step 1 Use your cell phone to scan the QR code under Cell Phone Client to download the application.

Step 2 On your cell phone, open the application, and then tap .

The menu is displayed. You can start adding the device.

- 1) Tap **Device Manager**.

Figure 5-24 Device manager

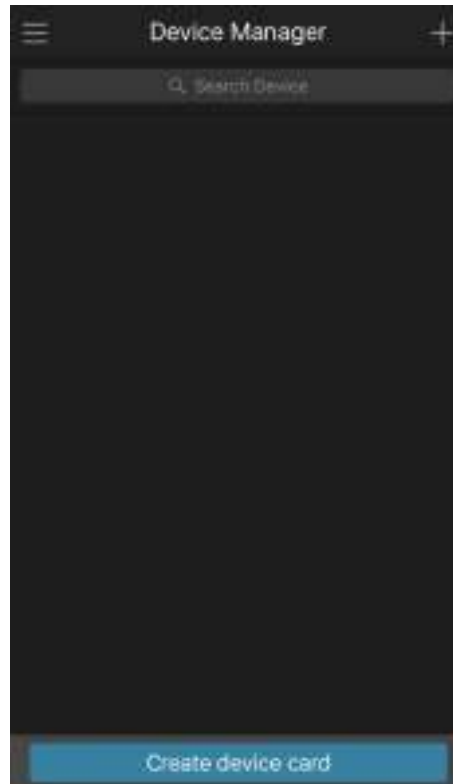



- 2) Tap  on the upper-right corner.
The page requiring device initialization is displayed. A pop-up message reminding you to make sure the Device is initialized is displayed.
- 3) Tap **OK**.
 - ◇ If the Device has not been initialized, Tap **Device Initialization** to perform initializing by following the onscreen instructions.
 - ◇ If the Device has been initialized, you can start adding it directly.
- 4) Tap **Add Device**.

You can add wireless device or wired device. The Manual takes adding wired device as an example.

Figure 5-25 Add

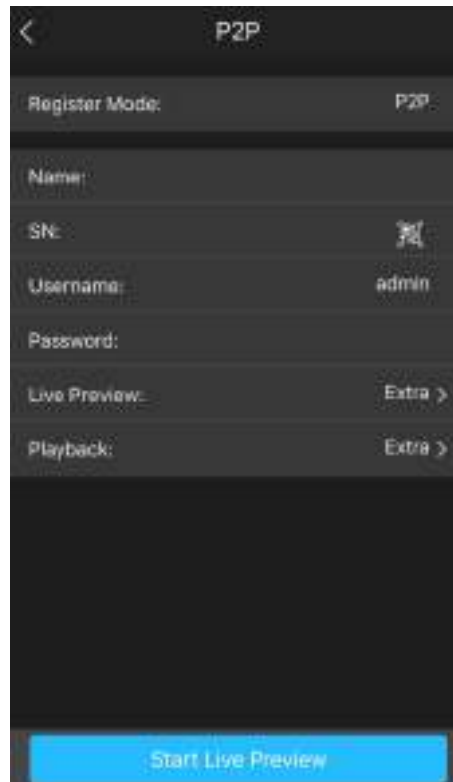
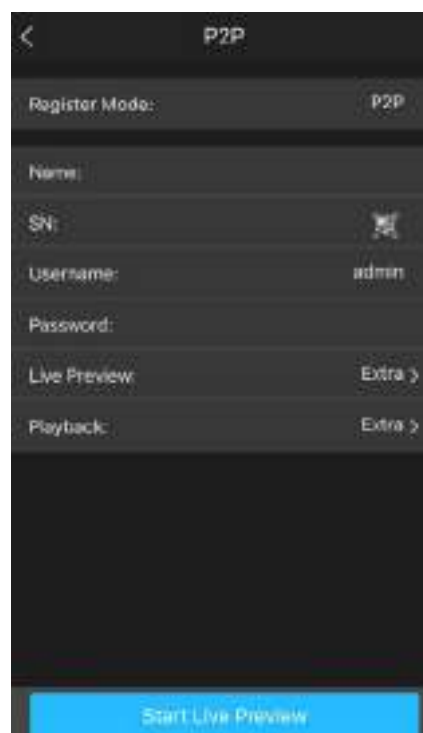

- 5) Tap P2P.

Figure 5-26 P2P



- 6) Enter a name for the DVR, the username and password, scan the QR code under **Device SN**.
- 7) Tap **Start Live Preview**.
The Device is added and displayed on the live view page of the cell phone.

Figure 5-27 Live preview



5.1.4.6 Configuring Encode Settings

You can configure the settings of main stream and sub stream for the Device.

You can also configure encode settings by selecting **Main Menu > CAMERA > Encode > Audio/Video**.

Step 1 After you have configured the P2P settings, on the **Audio/Video** page, click **Next**.

Figure 5-28 Encode

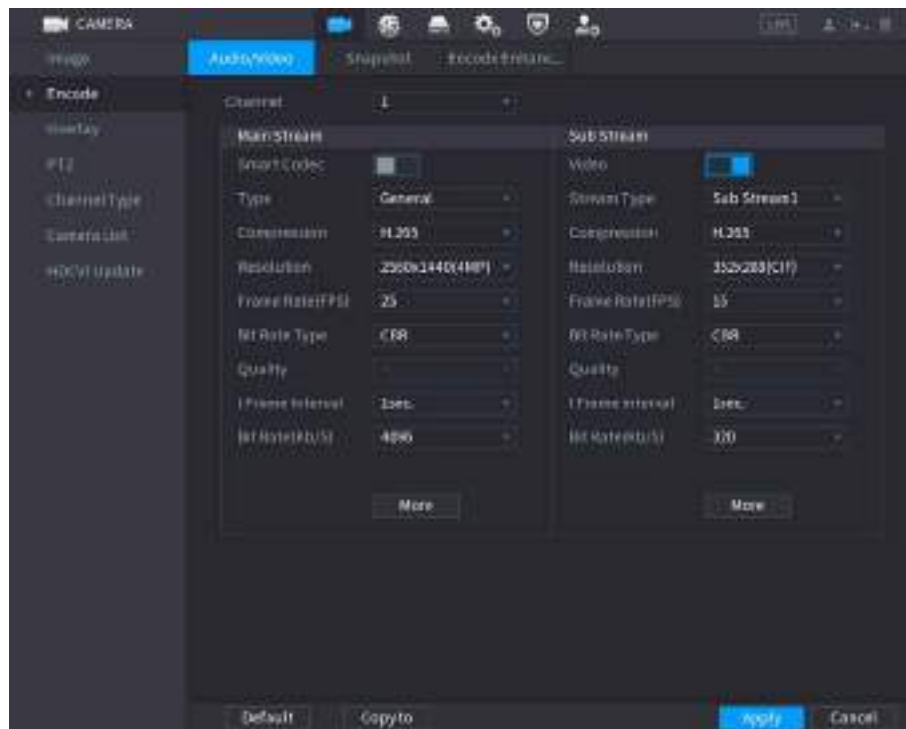

Step 2 Configure the settings for the main/sub streams parameters.

Table 5-5 Parameter description

Parameter	Description
Channel	In the Channel list, select the channel that you want to configure the settings for.
Smart Codec	Enable the smart codec function. This function can reduce the video bit stream for non-important recorded video to maximize the storage space.
Type	<ul style="list-style-type: none"> ● Main Stream: In the Type list, select General, MD (Motion Detect), or Alarm. ● Sub Stream: This setting is not configurable.
Compression	In the Compression list, select the encode mode. <ul style="list-style-type: none"> ● H.265: Main profile encoding. This setting is recommended. ● H.264H: High profile encoding. Low bit stream with high definition. ● H.264: Main profile encoding. ● H.264B: Baseline profile encoding. This setting requires higher bit stream compared with other settings for the same definition.
Resolution	In the Resolution list, select resolution for the video. The maximum video resolution might be different dependent on your device model.
Frame Rate (FPS)	Configure the frames per second for the video. The higher the value is, the clearer and smoother the image will become. Frame rate changes along with the resolution. Generally, in PAL format, you can select the value from 1 through 25; in NTSC format, you can select the value from 1 through 30. However, the actual range of frame rate that you can select depends on the capability of the Device.
Bit Rate Type	In the Bit Rate Type list, select CBR (Constant Bit Rate) or VBR (Variable Bit Rate). If you select CBR , the image quality cannot be configured; if you select VBR , the image quality can be configured.
Quality	This function is available if you select VBR in the Bit Rate List. The bigger the value is, the better the image will become.
I Frame Interval	The interval between two reference frames.
Bit Rate (Kb/S)	In the Bit Rate list, select a value or enter a customized value to change the image quality. The bigger the value is, the better the image will become.
Video	Enable the function for sub stream.
Audio	Click More , the More page is displayed. <ul style="list-style-type: none"> ● Audio: This function is enabled by default for main stream. You need to manually enable it for sub stream 1. Once this function is enabled, the recorded video file is composite audio and video stream.
Audio Source	<ul style="list-style-type: none"> ● Audio Source: In the Audio Source list, you can select Local and HDCVI. <ul style="list-style-type: none"> ◇ Local: The audio signal is input from Audio In port. ◇ HDCVI: The audio signal is input from HDCVI camera.
Compression	<ul style="list-style-type: none"> ● Compression: In the Compression list, select a format that you need.

5.1.4.7 Configuring Snapshot Settings

You can configure the basic snapshot settings such as quantity of snapshot each time, channel(s) to take snapshot, and image size and quality of snapshot.

You can also configure general settings by selecting **Main Menu > CAMERA > Encode > Snapshot**.

For more information about snapshot settings, see "5.8 Configuring Snapshot Settings".

Step 1 After you have configured the encode settings, on the **Encode** page, click **Next**.

Figure 5-29 Snapshot

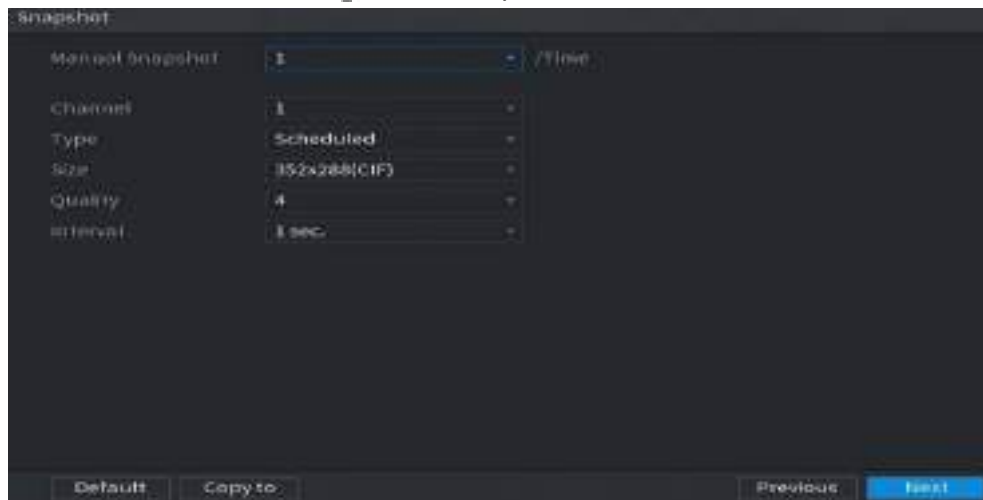

Step 2 Configure the settings for the snapshot parameters.

Table 5-6 Snapshot parameters

Parameter	Description
Manual Snapshot	In the Manual Snapshot list, select how many snapshots you want to take each time.
Channel	In the Channel list, select the channel that you want to configure the settings for.
Type	In the Mode list, you can select Human Face , Event , or General as the event type for which you want to take a snapshot. <ul style="list-style-type: none"> ● Scheduled: The snapshot is taken during the scheduled period. ● Event: The snapshot is taken when there is an alarm event occurs, such as motion detection event, video loss, and local alarms. ● Face Snapshot: The snapshot is taken when the face is detected. The face detection function is support only with the Channel 1.
Size	In the Size list, select a value for the image. The bigger the value is, the better the image will become.
Quality	Configure the image quality by 6 levels. The higher the level is, the better the image will become.
Interval	Configure or customize the snapshot frequency.

5.1.4.8 Configuring Basic Storage Settings

You can configure the settings for the situations when HDD is full, file length and time length of recorded video, and the settings if to auto-delete the old files.

You can also configure basic storage settings by selecting **Main Menu > STORAGE > Basic**.

Step 1 After you have configured the encode settings, on the **Snapshot** page, click **Next**.

Figure 5-30 Basic

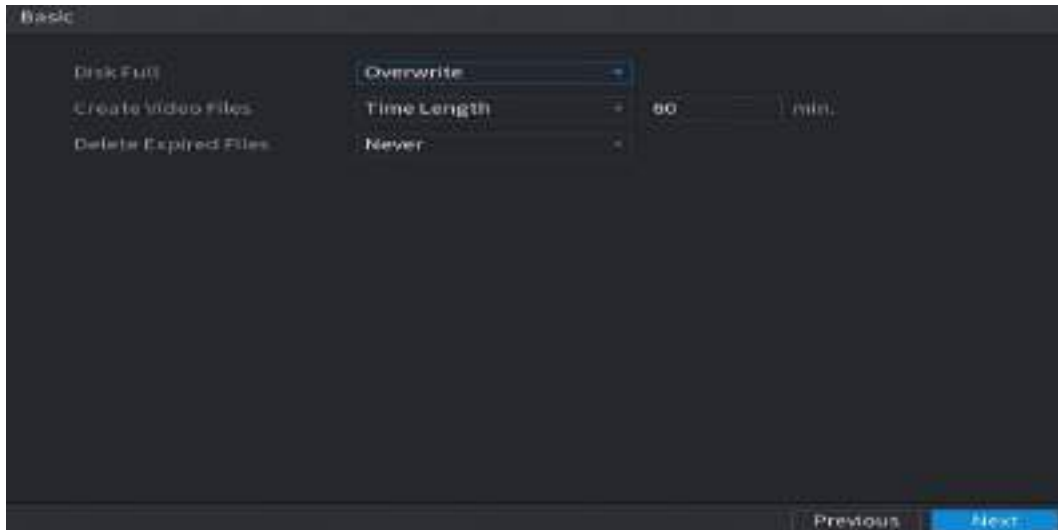

Step 2 Configure the basic storage settings parameters.

Table 5-7 Basic storage settings

Parameter	Description
Disk Full	Configure the settings for the situation when all the read/write discs are full, and there are no more free discs. <ul style="list-style-type: none"> ● Select Stop to stop recording ● Select Overwrite to overwrite the recorded video files always from the earliest time.  <p>The locked recorded video files will not be overwritten.</p>
Create Video Files	Configure the time length and file length for each recorded video.
Delete Expired Files	Configure whether to delete the old files and if yes, in the Delete Expired Files list, select Custom to configure the time length for how long you want to keep the old files.

5.1.4.9 Configuring Recorded Video Storage Schedule

You can configure the schedule for the recorded video such as channels to record, alarm settings, and the armed period.



You can also configure recorded video storage settings by selecting **Main Menu > STORAGE > Schedule > Record**.

Step 1 After you have configured the basic storage settings, on the **Basic** page, click **Next**.

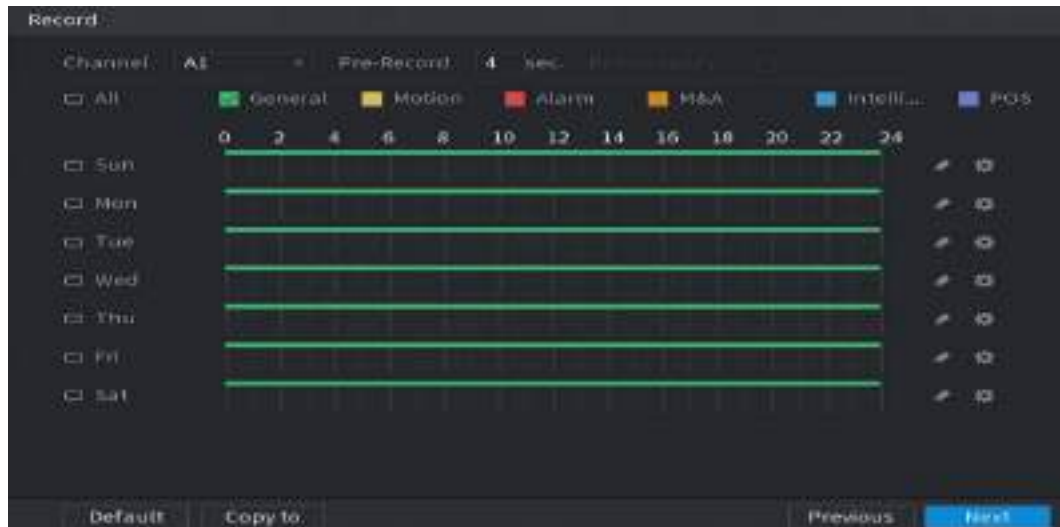
Figure 5-31 Record



Step 2 Configure the record settings parameters.

Parameter	Description
Channel	In the Channel list, select a channel to record the video.
Pre-record	In the Pre-record list, enter the amount of time that you want to start the recording in advance.
Redundancy	<p>If there are several HDDs installed to the Device, you can set one of the HDDs as the redundant HDD to save the recorded files into different HDDs. In case one of the HDDs is damaged, you can find the backup in the other HDD.</p> <ul style="list-style-type: none"> ● Select Main Menu > STORAGE > Disk Manager, and then set a HDD as redundant HDD. ● Select Main Menu > STORAGE > Schedule > Record, and then select the Redundancy checkbox. <ul style="list-style-type: none"> ◇ If the selected channel is not recording, the redundancy function takes effect next time you record no matter you select the checkbox or not. ◇ If the selected channel is recording, the current recorded files will be packed, and then start recording according to the new schedule. <p> Not all models support this function.</p> <p> The redundant HDD only back up the recorded videos but not snapshots.</p>
Event type	Select the checkbox of the event type which includes General , Motion (motion detect, video loss, tempering, diagnosis), Alarm (IoT alarms, local alarms, alarms from alarm box, IPC external alarms, IPC Offline alarms), M&A , Intelligent (IVS events, face detection), and POS .
Period	<p>Define a period during which the configured recording setting is active.</p> <p> The system only activates the alarm in the defined period.</p>
Copy	Click Copy to to copy the settings to other channels.

Step 3 Define the video recording period by drawing or editing. By default, it is active all the time.

- Define the period by drawing.

- 1) Select the checkbox of event type.

Figure 5-32 Event type

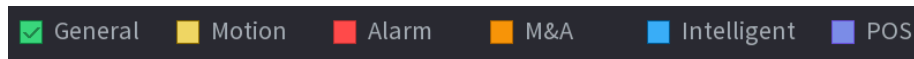

- 2) Define a period. The system supports maximum six periods.
 - ◇ Define for the whole week: Click next to **All**, all the icon switches to , you can define the period for all the days simultaneously.
 - ◇ Define for several days of a week: Click before each day one by one, the icon switches to . You can define the period for the selected days simultaneously.
- 3) On the timeline, drag to define a period. The Device starts recoding the selected event type in the defined period.

Figure 5-33 Timeline



The color bar indicates the event type that is effective in a defined period:



- Recording priority in case of event types are overlapped: **M&A > Alarm > Intelligent > Motion > General.**
- Select the checkbox of event type, and then click to clear the defined period.
- When selecting **M&A**, the M&A and Alarm checkboxes will be cleared respectively.
- Define the period by editing. Take Sunday as an example.
 - 1) Click .

Figure 5-34 Period

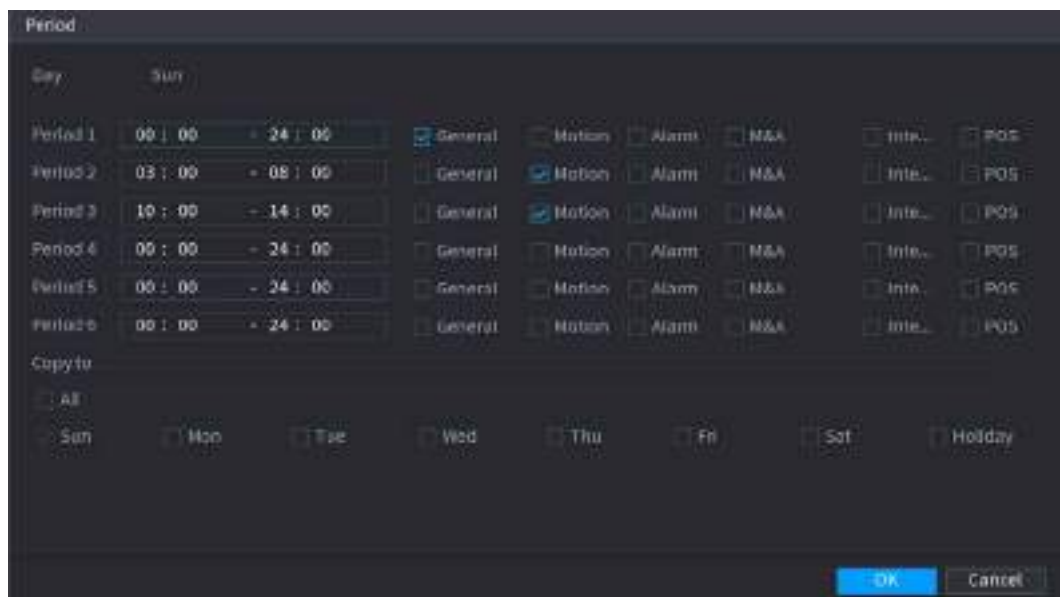

- 2) Enter the time frame for the period and select the event checkbox.
 - ◇ There are six periods for you to set for each day.
 - ◇ Under **Copy to**, select **All** to apply the settings to all the days of a week, or select specific day(s) that you want to apply the settings to.
- 3) Click **OK** to save the settings.

Step 4 Click **OK** to complete the settings.



- Click **Copy** to copy the settings to other channels.
- After configuring the recording schedule settings, you need to perform the following operations to start recording according to the defined schedule.
 - ◇ Enable the alarm event and configure the settings for the recording channel. For details, see "5.10 Alarm Events Settings".
 - ◇ You need to enable the recording function, see "5.9.1 Enabling Record Control".

5.1.4.10 Configuring Snapshot Storage Schedule

You can configure the storage schedule for the snapshot such as channels to take snapshot, alarm settings, and the armed period.

You can also configure snapshot storage settings by selecting **Main Menu > STORAGE > Schedule > Snapshot**.

Step 1 After you have configured the video recording settings, on the **Record** page, click **Next**.

Figure 5-35 Snapshot



Step 2 Configure the snapshot settings parameters.

Parameter	Description
Channel	In the Channel list, select a channel to take a snapshot.
Event type	Select the checkbox of the event type which includes General, Motion, Alarm, M&A, Intelligent, and POS.
Period	Define a period during which the configured snapshot setting is active. For details about defining a period, see "5.1.4.9 Configuring Recorded Video Storage Schedule".
Copy	Click Copy to to copy the settings to other channels.

Step 3 Click **OK**.

Step 4 Click **OK**.

The live view screen is displayed. The setting up with startup wizard is completed. You can start using the Device.

Step 5 (Optional) After the setting with startup wizard is completed, if the connected HDMI display resolution is inconsistent with default resolution (1280*1024), a dialog box will pop up. Choose to switch the resolution or not.

Figure 5-36 Change resolution

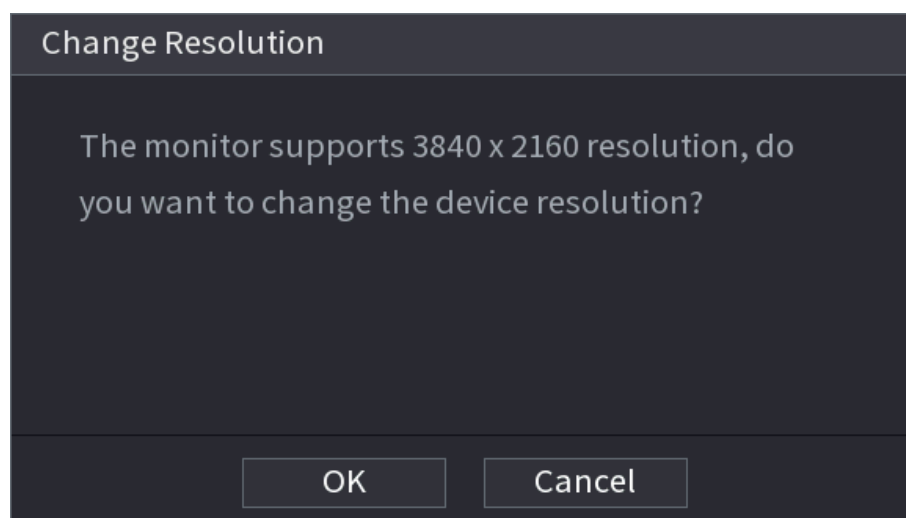

5.2 Live View

After you logged in the Device, the live view is displayed. The number of channels displayed depends on your model.

To enter the live view screen from other pages, click  on the upper-right corner of the screen.

Figure 5-37 Live view







5.2.1 Live View Screen

You can view the live video from the connected cameras through each channel on the screen.

- By default, the system time, channel name and channel number are displayed on each channel window. This setting can be configured by selecting **Main Menu > CAMERA > Overlay > Overlay**.
- The figure in the bottom right corner represents channel number. If the channel position is changed or the channel name is modified, you can recognize the channel number by this figure and then perform the operations such as record query and playback.

Table 5-8 Live view description

Icon	Function
	Indicates recording status. This icon displays when the video is being recorded.
	This icon displays when the motion detection occurs in the scene.
	This icon displays when the video loss is detected.
	This icon displays when the channel monitoring is locked.



To switch the position of two channels, point to one of the two channels, and then drag the window to the other channel.

5.2.2 Live View Control bar

The live view control bar provides you access to perform the operations such as playback, zoom, real-time backup, manual snapshot, voice talk, adding remote devices, and streams switch.

When you move the pointer to the top middle position of a channel window, the live view control bar is displayed.



If there is not operation for six seconds after the control bar is displayed, the control bar hides automatically.

Figure 5-38 Analog channel



Figure 5-39 Digital channel



Figure 5-40 Control bar description

No.	Function	No.	Function	No.	Function
1	Instant Playback	4	Manual Snapshot	7	Camera Registration
2	Digital Zoom	5	Mute	—	—
3	Instant Record	6	Audio Talk	—	—

5.2.2.1 Instant Playback

You can play back the previous 5 seconds to 60 minutes of the recorded video.

By clicking , the instant playback page is displayed. The instant playback has the following features:

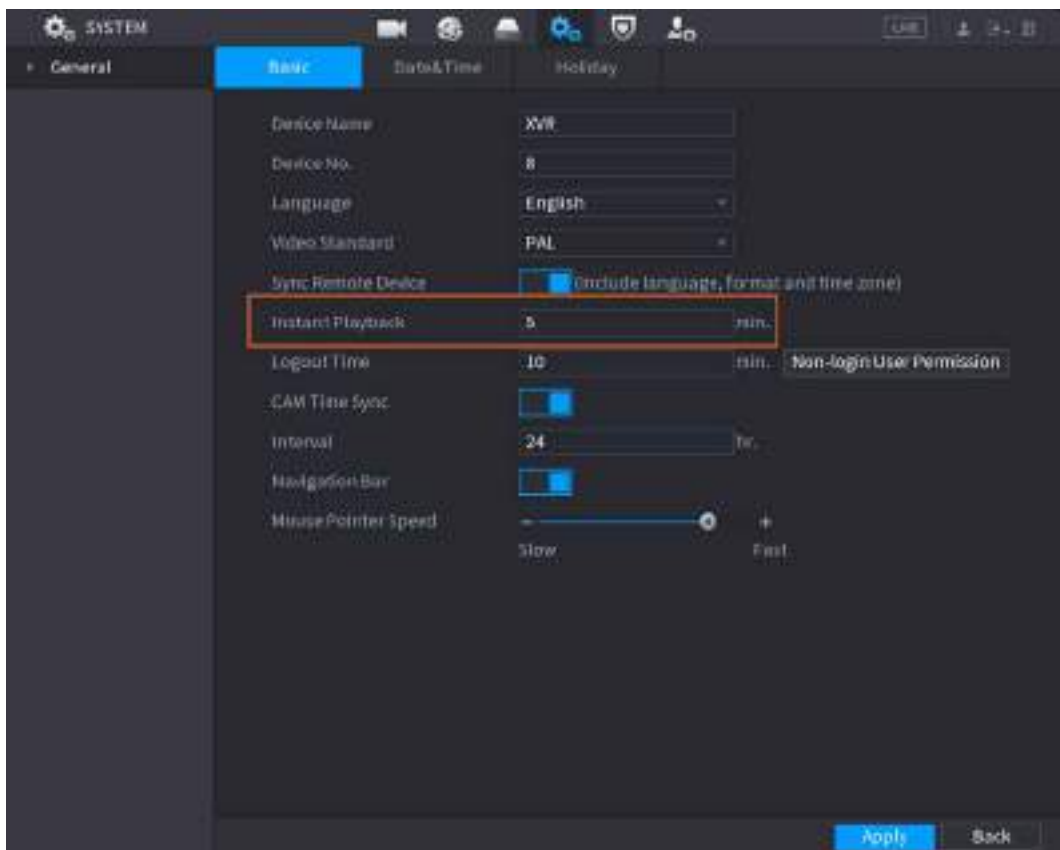

- Move the slider to choose the time you want to start playing.
- Play, pause and close playback.
- The information such as channel name and recording status icon are shielded during instant playback and will not display until exited.
- During playback, screen split layout switch is not allowed.
- To change the playback time, select **Main Menu > SYSTEM > General > Basic**, in the **Instant Play** box, enter the time you want to play back.

Figure 5-41 General



5.2.2.2 Digital Zoom

You can enlarge a specific area of the image to view the details by either of the following two ways.

- Click , the icon switches to . Hold down the left mouse button to select the area you want to enlarge. The area is enlarged after the left mouse button is released.
- Point to the center that you want to enlarge, rotate the wheel button to enlarge the area.



- For some models, when the image is enlarged in the first way described previously, the selected area is zoomed proportionally according to the window.
- When the image is in the enlarged status, you can drag the image toward any direction to view the other enlarged areas.
- Right-click on the enlarged image to return the original status.

5.2.2.3 Instant Record

You can record the video of any channel and save the clip into a USB storage device.

By clicking , the recording is started. To stop recording, click this icon again. The clip is automatically saved into the connected USB storage device.

5.2.2.4 Manual Snapshot

You can take one to five snapshots of the video and save into a USB storage device.

By clicking , you can take snapshots. The snapshots are automatically saved into the connected USB storage device. You can view the snapshots on your PC.



To change the quantity of snapshots, select **Main Menu > CAMERA > ENCODE > Snapshot**, in the **Manual Snap** list, select the snapshot quantity.

5.2.2.5 Mute (Analog channel only)

You can mute the video sound by clicking . This function is supported in single-channel view.

5.2.2.6 Warning Light (Supported on Camera with Warning Light Function)



Click  to manually control the camera to turn on the warning light function.

5.2.2.7 Siren (Supported on Camera with Siren Function)

Click  to manually control the camera to generate alarm sound.

5.2.2.8 Two-way Talk (Digital channel Only)

You can perform the voice interaction between the Device and the remote device to improve efficiency of emergency. This function is supported only when the remotely connected IPC device supports bidirectional talk.

- Click , the icon switches to , the bidirectional talk of the remote device is turned on. The bidirectional talk of other digital channels is disabled.
- Click  to cancel the bidirectional talk. The bidirectional talk of other digital channels is resumed.

5.2.2.9 Adding Camera (Digital channel Only)

You can view the information of remote devices and add new remote devices to replace the current connected devices.

By clicking , the **Camera List** page is displayed. For details about adding the remote devices, see "5.6 Configuring Remote Devices".

5.2.3 Navigation Bar

You can access the functions to perform operations through the function icons on the navigation bar. For example, you can access Main Menu and switch window split mode.



















The navigation bar is disabled by default. It does not appear in the live view screen until it is enabled. To enable it, select **Main Menu > SYSTEM > General > Basic**, enable the Navigation Bar, and then click **Apply**.

Figure 5-42 Navigation bar



Table 5-9 Navigation bar description

Icon	Function
	Open Main Menu .
	Expand or condense the navigation bar.
	Select view layout.
	Go to the previous screen.
	Go to the next screen.
	Enable tour function. The icon switches to  .
	Open the PTZ control panel. For details, see "5.4 Controlling PTZ Cameras".
	Open the Image page.  This function is supported only in single-channel layout.
	Open the record search page. For detail, see "5.9 Playing Back Video".
	Open the Alarm Status page to view the device alarm status. For details, see "5.21.3 Viewing Event Information".
	Open the CHANNEL INFO page to display the information of each channel.
	Open the Camera List page. For details, see "5.6.1 Adding Remote Devices".

Icon	Function
	Open the Network page. For details, see "5.15.1 Configuring Network Settings".
	Open the Disk Manager page. For details, see "5.18.3 Configuring Disk Manager".
	Open the USB Management page. For details about USB operations, see "5.14.2 Backing up Files", "5.21.2 Viewing Log Information", "5.20.4 Exporting and Importing System Settings", "5.20.6 Updating the Device".

5.2.4 Shortcut Menu

You can quickly access some function pages such as main menu, record search, PTZ setting, color setting and select the view split mode.

Right-click on the live view screen, the shortcut menu is displayed.



After you access any page through shortcut menu, you can return to the previous screen by right-clicking on the current screen.

Figure 5-43 Shortcut menu

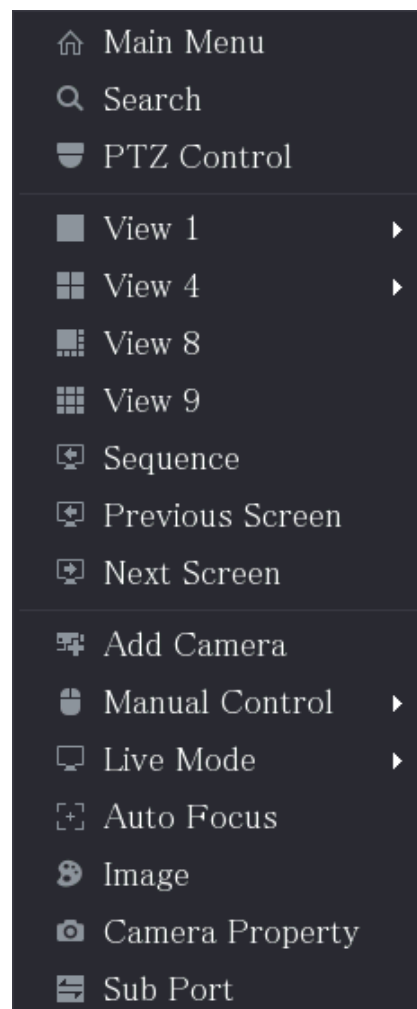



Table 5-10 Menu parameters

Function	Description
Main Menu	Open Main Menu page.
Search	Open the PLAYBACK page where you can search and play back record files.
PTZ	Open the PTZ page.
View Layout	Configure the live view screen as a single-channel layout or multi-channel layout.
Previous Screen	Click Previous Screen to go to the previous screen. For example, if you are using 4-split mode, the first screen is displaying the channel 1-4, click Next screen , you can view channel 5-8.
Next Screen	
Add Camera	Open the Camera List page. For details, see "5.6 Configuring Remote Devices".  This parameter displays on the right-click menu only after setting at least one channel to IP type in Main Menu > CAMERA > Channel Type .
Manual Control	<ul style="list-style-type: none"> ● Select Record Mode, you can configure the recording mode as Auto or Manual, or stop the recording. You can also enable or disable snapshot function ● Select Alarm Mode, you can configure alarm output settings.
Live Mode	<ul style="list-style-type: none"> ● Select General, the layout of live view screen is as default. ● Select Face, the detected face snapshots are displayed in the bottom of the live view screen.
Auto Focus	Point to the channel window and right-click on it to open the shortcut menu, and then click Auto Focus .  Not all cameras support this function.
Image	Open the Image page where you can adjust the video image color.
Camera Property	Click to modify the camera properties.
Sub Port	Click to switch to extra screen control.

5.2.5 AI Preview Mode

You can view the detected faces snapshots and comparison results of detected faces and the faces in the database, and play back the recorded picture file.

To display the AI preview mode, the face detection function must be enabled. For details, see "5.11.1.1 Face Detection".

Right-click on the live view screen to display the shortcut menu, and then select **Live Mode > AI Mode**, the AI preview mode page is displayed.

Figure 5-44 Live view

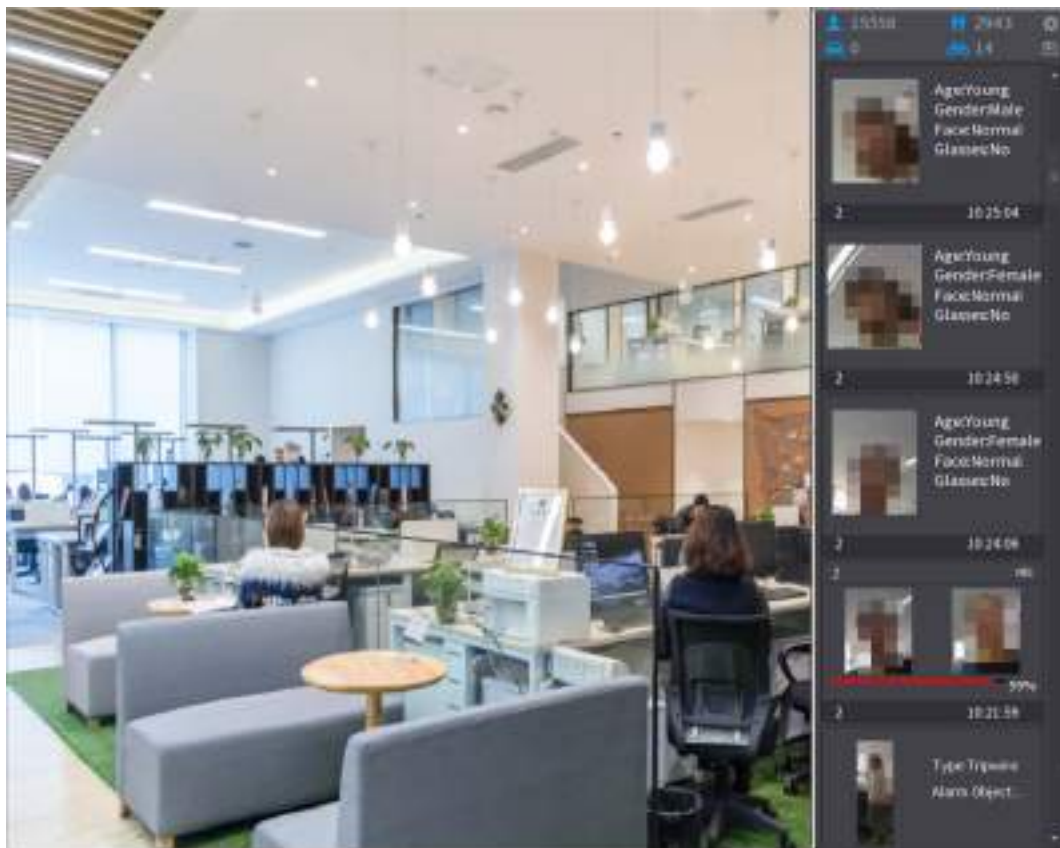

- 15558: Indicates the quantity of detected faces from 0 A.M. to midnight.
- 2943: Indicates the quantity of detected humans 0 A.M. to midnight.
- 0: Indicates the quantity of detected motor vehicles 0 A.M. to midnight.
- 14: Indicates the quantity of detected non-motor vehicles 0 A.M. to midnight.
- : Click this icon and then select the face attributes that you want to display on the AI preview mode. Maximum four attributes are supported to display.
- : Click this icon to export counting report in .csv format. The report information includes date, starting time, ending time, and the number of human, vehicle and face. The title of report is named as "device name_XVR_AI_Statistics_starting time_ending time.csv".

Figure 5-45 Properties

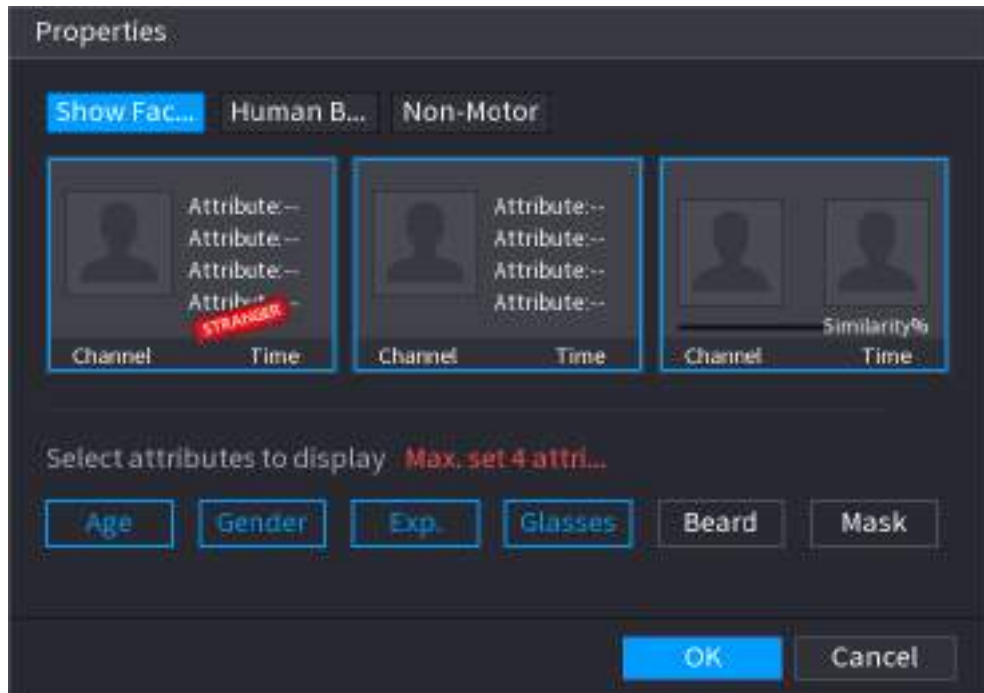

5.2.6 Channel Sequence

You can adjust the channel sequence displayed on live page on actual needs.



The live view page displays the default channel sequence after restoring factory defaults.

Step 1 Right-click on the live view page and select **Sequence**.



- The system displays the maximum number of window splits supported by the DVR after selecting **Sequence**.
- The **Sequence** page displays only the channel name and channel number of added remote devices. ● represents the remote device is online, and ● represents the remote device is offline.

Figure 5-46 Sequence

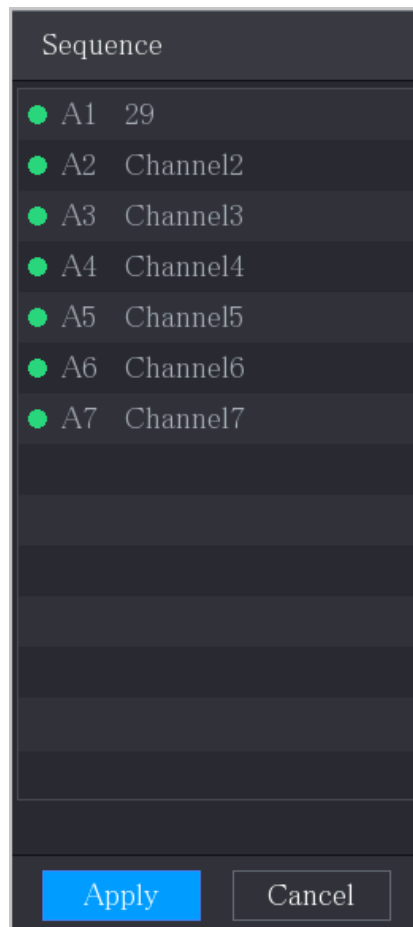

Step 2 Adjust channel sequence.

- Drag a channel to the target window split.
- Drag a window split to another to change the sequence.

You can view the channel sequence according to the channel number on the lower-right corner of the window split.

Figure 5-47 Adjusted sequence

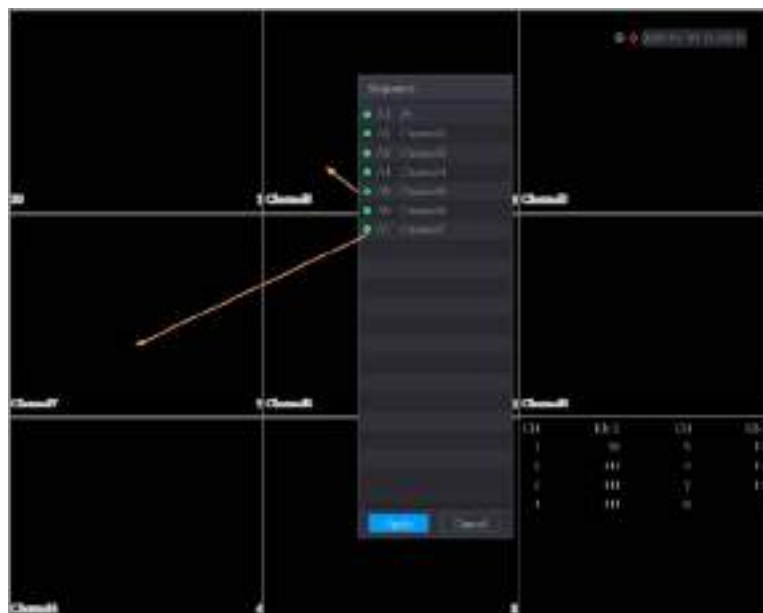

5.2.7 Color Setting

You can adjust the video image color effect such as sharpness, brightness, and contrast. The parameters are different according to the connected camera type. Take analog channel as an example.



Parameters displayed on the page vary from different cameras.

In the live view screen, right-click on the analog channel to see the shortcut menu, and then select **Image**, the **Image** page is displayed.

For details, see "5.5.1 Configuring Image Settings".

Figure 5-48 Image

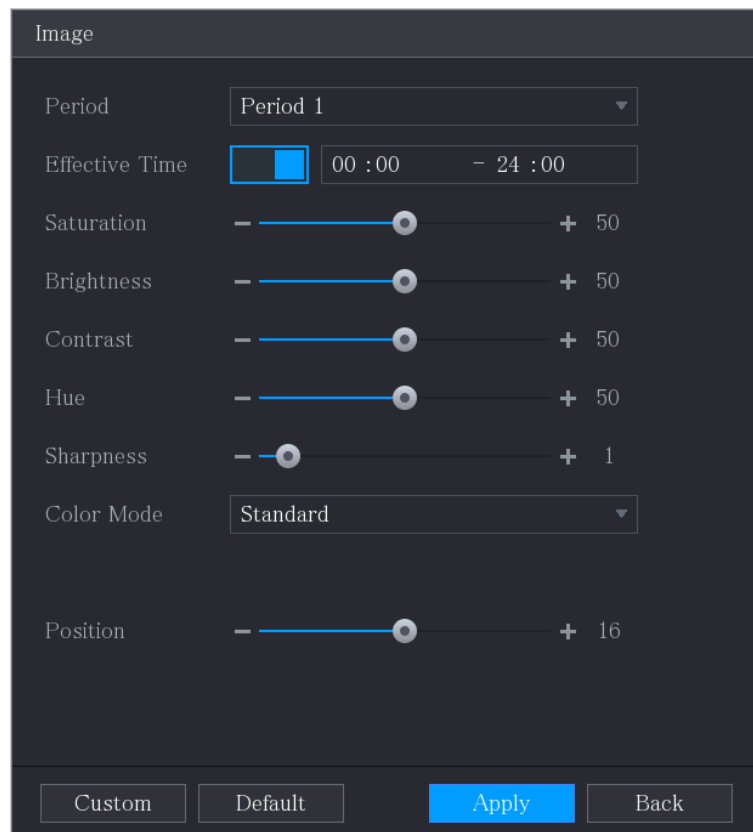





Table 5-11 Image settings

Parameter	Description
Period	Divide 24 hours into two periods and configure the corresponding color settings.
Effective Time	Enable the function and then set the effective time for each period.
Sharpness	Adjust the sharpness of image edge. The bigger the value is, the more obvious the image edge, and the noise is also greater. The value ranges from 1 to 15. The default value is 1.
Hue	Adjust the hue of image. The value ranges from 0 to 100. The default value is 50.

Parameter	Description
Brightness	<p>Adjust the image brightness. The value ranges from 0 to 100. The default value is 50.</p> <p>The bigger the value is, the brighter the image will become. You can adjust this value when the image as a whole looks dark or bright. However, the image is likely to become dim if the value is too big. The recommended range is between 40 and 60.</p>
Contrast	<p>Adjust the image contrast. The bigger the value is, the more obvious the contrast between the light area and dark area will become. You can adjust this value when the contrast is not obvious. However, if the value is too big, the dark area is likely to become darker and the light area over exposed. If the value is too small, the image is likely to become dim. The value ranges from 0 to 100. The default value is 50. The recommended range is between 40 and 60.</p>
Saturation	<p>Adjust the color shades. The bigger the value, the lighter the color will become. This value does not influence the general image lightness. The value ranges from 0 to 100. The default value is 50. The recommended range is between 40 and 60.</p>
Color Mode	<p>In the Color Mode list, you can select Standard, Soft, Bright, Vivid, Bank, Customized 1, Customized 2, Customized 3, and Customized 4. The sharpness, hue, brightness, contrast and saturation will adjust automatically according to the selected color mode.</p>
EQ	<p>Enhance the image effect. Adjust the effect value.</p> <ul style="list-style-type: none"> ● Click , image is adjusted to the optimized effect automatically. ● Click , the current effect setting will be locked. <p> Only HD analog channel supports this function.</p>
Position	<p>Adjust the display position of the image in the channel window. The value indicates pixel. The default value is 16.</p> <p> This function is only supported by analog channel.</p>
Custom	<p>You can customize four color modes.</p> <ol style="list-style-type: none"> 1. Click Custom. The Custom Color page is displayed. 2. In the Color Mode list, select Custom 1, for example. Then configure the settings for sharpness, hue, brightness, contrast and saturation. If you select All, the configuration will apply to all four customized color modes. 3. Click OK. 4. On the Image page, in the Color Mode list, you can select the customized color mode.

5.2.8 Live View Display

5.2.8.1 Configuring Display Settings

You can configure the display effect such as displaying time title and channel title, adjusting image transparency, and selecting the resolution.

Step 1 Select **Main Menu > DISPLAY > Display**.



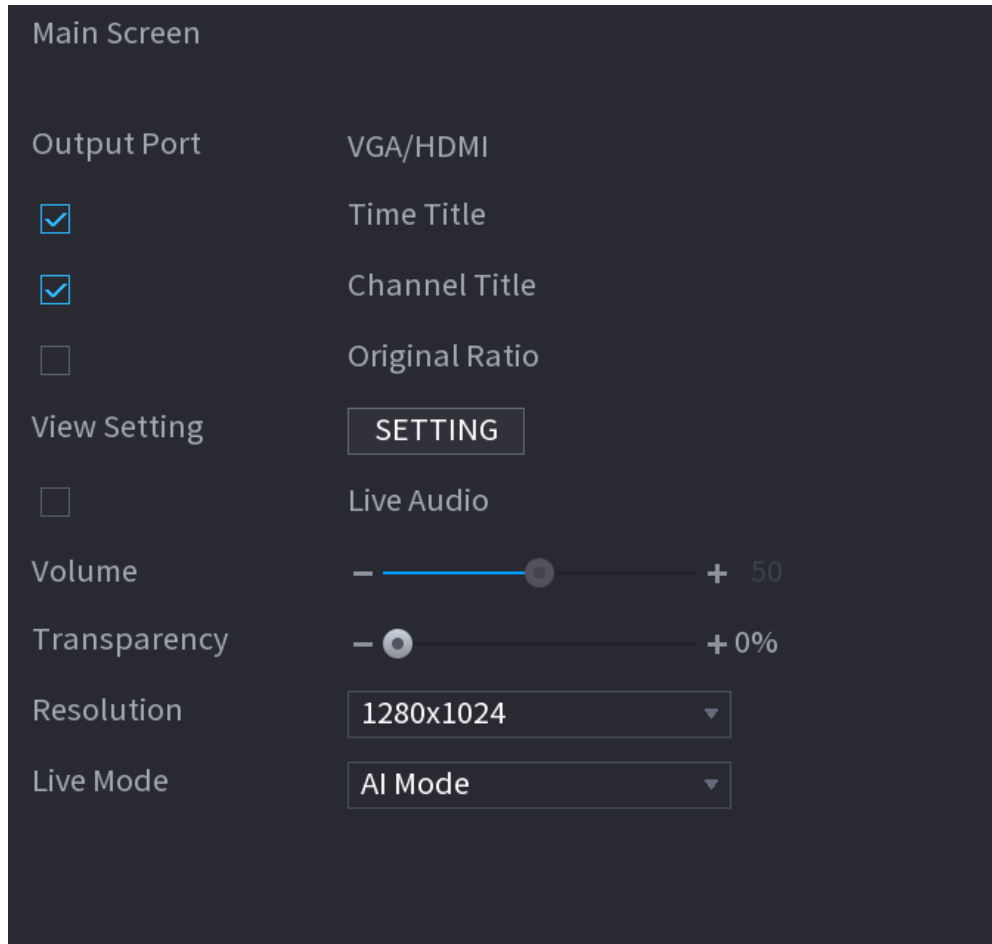

Figure 5-49 Display



Step 2 Configure the settings for the display parameters.

Table 5-12 Display parameters

Parameter		Description
Main Screen	Output Port	Indicates the main screen port.
	Time Title	Select the Time Title checkbox, the current system time displays in each channel window in live view screen. To hide the time, clear the checkbox.
	Channel Title	Select the Channel Title checkbox, the channel name, channel number and recording status display in each channel window in live view screen. To hide the time, clear the checkbox.
	Original Ratio	Select the Original Ratio checkbox, the video image displays in its actual size in the channel window.

Parameter		Description
	View Setting	Click SETTING to enable AI rule, bounding box of IVS target and SMD rule on the live page.
	Live Audio	Select the Live Audio checkbox to enable the audio adjustment function in the channel window on the live view screen.
	Volume	Move the slider to adjust the volume of live audio.
	Transparency	Configure the transparency of the graphical user interface (GUI). The higher the value, the more transparent the GUI becomes.
	Resolution	Select resolution for the video. The default resolution for VGA port and HDMI port is 1280 × 1024.  Some of the resolution options might not be supported on the HDMI port.
	Live Mode	<ul style="list-style-type: none"> General: No information is displayed on the channel window. AI Mode: Displays the detected face snapshots.  Not all models support this function.
Sub Screen	Enable	Enable extra screen function. After this function is enabled, you can select which port as extra screen port, and the other port automatically becomes the main screen port.
	Output Port	Select the VGA port or HDMI port as the port connected by a secondary monitor. For example, if you select HDMI port as the extra screen port, the VGA port automatically becomes the main screen port.
	Resolution	Select resolution for the video. The default resolution for VGA port and HDMI port is 1280 × 720.  Some of the resolution options might not be supported on the HDMI port.
	Show Message	After it is enabled, the sub screen will display alarm message when an alarm is triggered.
		 <ul style="list-style-type: none"> The main menu does not display on the extra screen. If you do not enable the extra screen function, both the VGA port and HDMI port display the same image.

5.2.8.2 Configuring Zero-Channel Settings

You can view several video sources on one channel on the web end.

Step 1 Select **Main Menu > DISPLAY > Zero-Channel**.

Figure 5-50 Zero-channel

Step 2 Configure the settings for the zero-channel parameters.

Table 5-13 Zero-channel parameters

Parameter	Description
Enable	Enable zero-channel function.
Compression	In the Compression list, select the video compression standard according to the device capability. The default is H.265.
Resolution	In the Resolution list, select the video resolution. The default is 704 × 576 (D1).
Frame Rate (FPS)	Select a value between 1 and 25 for PAL standard, and between 1 and 30 for NTSC standard. The actual arrange is decided and selected dependent on the Device capability.
Bit Rate (Kb/S)	The default value is 1024Kb/S. The actual arrange is decided and selected dependent on the Device capability and frame rate.

Step 3 Click **Apply** to save the settings.

In the live page on the web, click  to select one of the multi-channel modes, and then you can view the local video image.

5.2.8.3 Configuring TV



Not all models support this function.

You can adjust the border margins in top, bottom, left and right directions as well as the brightness of the monitor connected to the Video out port of the Device.

Step 1 Select **Main Menu > DISPLAY > TV Adjust**.

Figure 5-51 TV adjust

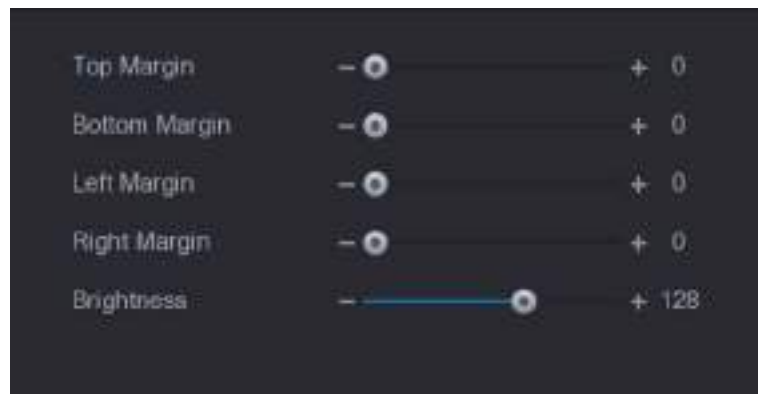

Step 2 Configure the parameters according to your actual situation.

Step 3 Click **Apply** to complete the settings.

5.2.9 Configuring Tour Settings

You can configure a tour of selected channels to repeat playing videos. The videos display in turn according to the channel group configured in tour settings. The system displays one channel group for a certain period and then automatically changes to the next channel group.

Step 1 Select **Main Menu > DISPLAY > Tour Setting**.

Figure 5-52 Main screen

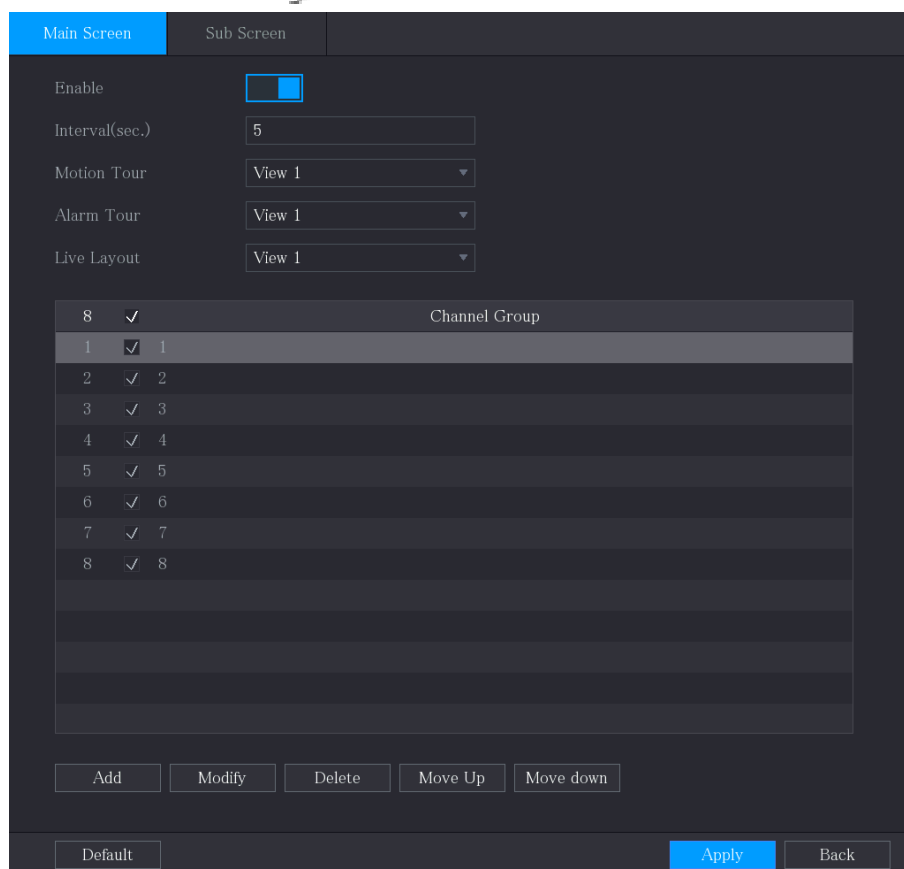
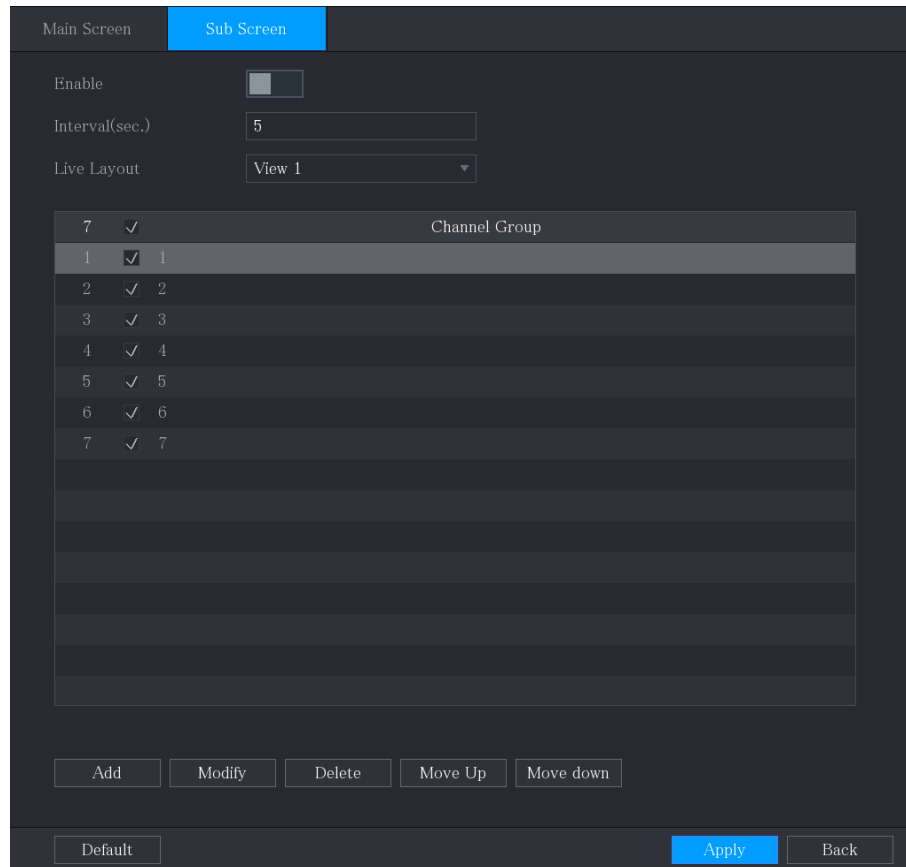

Figure 5-53 Sub screen







Step 2 Configure the settings for the tour parameters for both Main Screen and Extra Screen.

Figure 5-54 Tour parameters

Parameter	Description
Enable	Enable tour function.
Interval (Sec.)	Enter the amount of time that you want each channel group displays on the screen. The value ranges from 5 seconds to 120 seconds, and the default value is 5 seconds.
Motion Tour, Alarm Tour	Select the View 1 or View 8 for Motion Tour and Alarm Tour (system alarm events).
Live Layout	In the Live Layout list, select View 1 , View 4 , View 8 , or other modes that are supported by the Device.
Channel Group	Display all channel groups under the current Window Split setting. <ul style="list-style-type: none"> ● Add a channel group: Click Add, in the pop-up Add Group channel, select the channels to form a group, and then click Save. ● Delete a channel group: Select the checkbox of any channel group, and then click Delete. ● Edit a channel group: Select the checkbox of any channel group and then click Modify, or double-click on the group. The Modify Channel Group dialog box is displayed. You can regroup the channels. ● Click Move up or Move down to adjust the position of channel group.

Step 3 Click **Apply** to save the settings.



- On the upper-right corner of the live view screen, use the left mouse button or press Shift to switch between  (image switching is allowed) and  (image switching is not allowed) to turn on/off the tour function.
- On the navigation bar, click  to enable the tour and click  to disable it.

Adding a Channel Group

Step 1 Click Add.

Figure 5-55 Add group

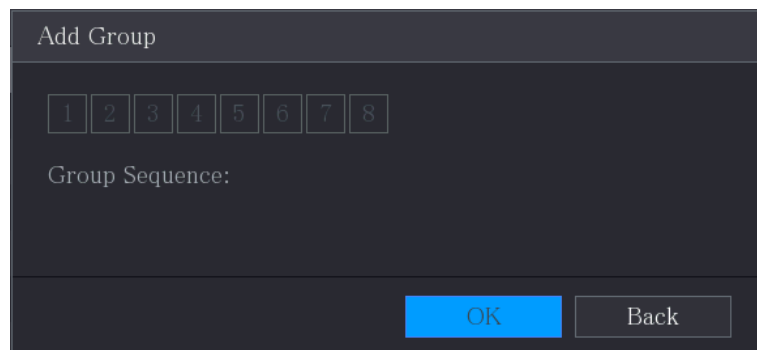

Step 2 Select the channels that you want to group for tour.



If you want to select more than one channel, in the **Live Layout** list, do not select **View 1**.

Figure 5-56 Add view

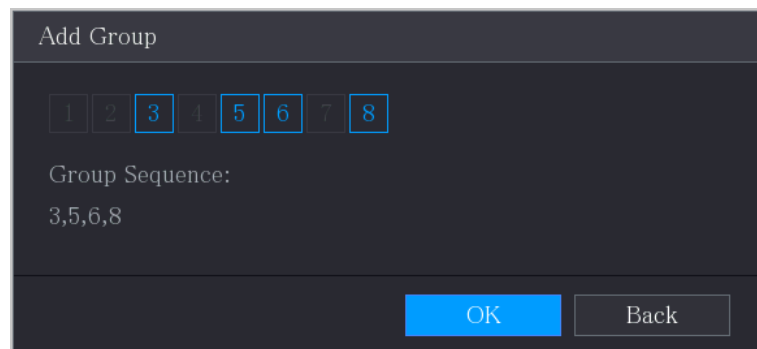

Step 3 Click **OK** to complete the settings.

Modifying a Channel Group

Double-click on a channel group, the **Channel Group Modified** page is displayed.

You can modify channel group and click **OK** to complete the settings.

Figure 5-57 Group modified

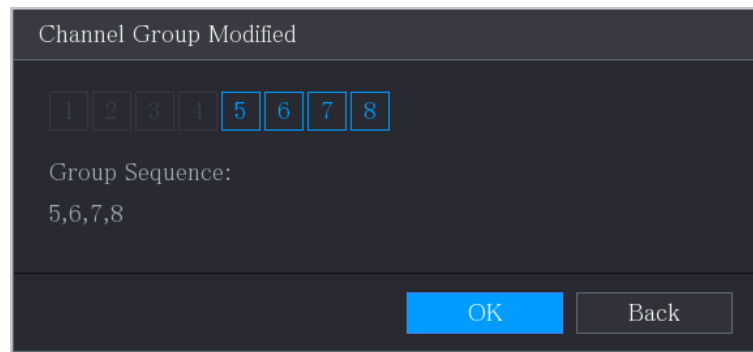

5.2.10 Quick Operation Bar

You can quickly access to the function modules on function tiles and setting menu through shortcut icons on quick operation bar.

This topic uses **ALARM** and **CAMERA** as examples to show you how to quickly access to other modules.

Shortcut Icons on Function Titles

Click **ALARM** to enter the **ALARM** page.

Figure 5-58 Alarm

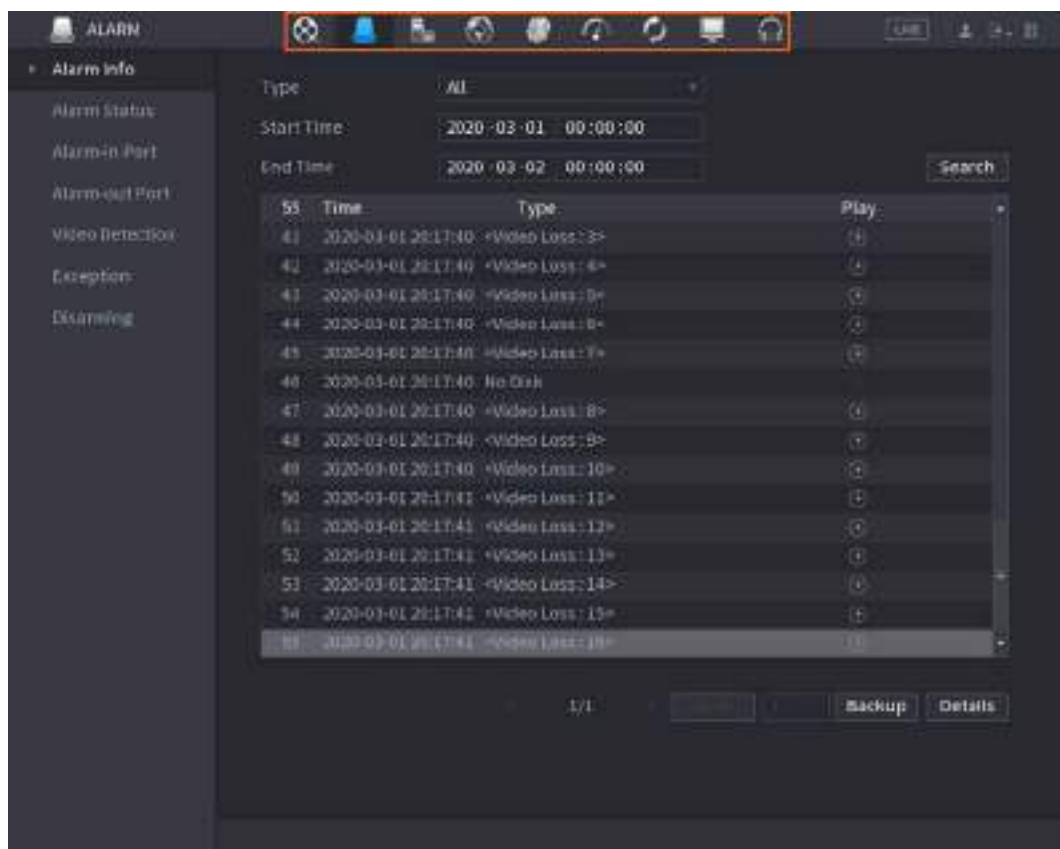

Table 5-14 Alarm parameters

Icon	Description
	Click to go to SEARCH page.
	Click to go to ALARM page.
	Click to go to AI page.
	Click to go to POS page.
	Click to go to NETWORK page.
	Click to go to MAINTAIN page.
	Click to go to BACKUP page.
	Click to go to DISPLAY page.
	Click to go to AUDIO page.

Shortcut Icons on Setting Menu

Click **CAMERA** to enter the **CAMERA** page.

Figure 5-59 Camera

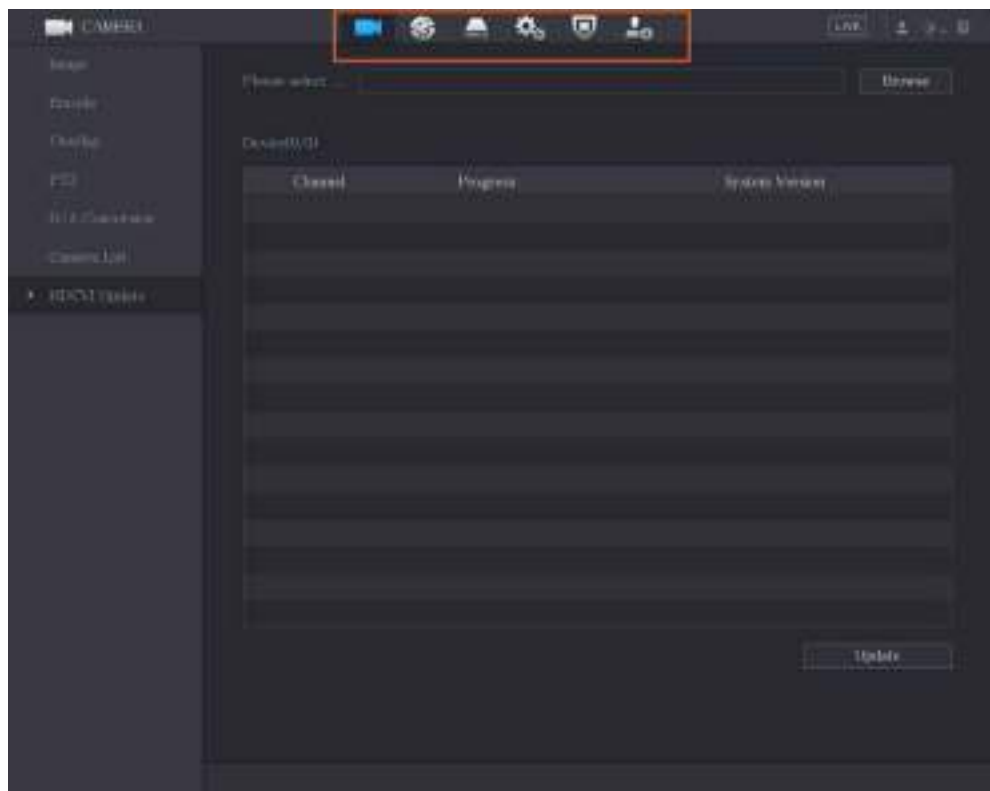

Table 5-15 Camera parameters

Icon	Description
	Click to go to CAMERA page.
	Click to go to NETWORK page.
	Click to go to STORAGE page.
	Click to go to SYSTEM page.
	Click to go to SECURITY page.
	Click to go to ACCOUNT page.











5.3 Entering Main Menu

Right-click on the live view screen, the shortcut menu is displayed, Click Main Menu and then log in to the system.

Figure 5-60 Main menu



Table 5-16 Main menu description

No.	Icon	Description
1	Function tiles	<p>Includes nine function tiles: SEARCH, ALARM, SMART DETECTION, POS, IoT, MAINTAIN, BACKUP, DISPLAY and AUDIO. Click each tile to open the configuration page of the tile.</p> <ul style="list-style-type: none"> ● SEARCH: Search for and play back the recorded video saved on the Device. ● ALARM: Search for alarm information and configure alarm event actions. ● SMART DETECTION: Search SMD, face detection, and IVS information, and configure related settings. ● POS: You can connect the Device to the POS (Point of Sale) machine and receive the information from it. ● IoT: IoT live video preview, search, export reports, and configure function settings. ● MAINTAIN: You can view log and system information, test network and do other maintenance work. ● BACKUP: Search and back up the video files to the external storage device such as USB storage device. ● DISPLAY: Configure the display effect such as displaying content, image transparency, and resolution, and enable the zero-channel function. ● AUDIO: Manage audio files and configure the playing schedule. The audio file can be played in response to an alarm event if the voice prompts function is enabled.
2	Switch icon	<p> indicates the current page of main menu. Click  to switch to the next page or click  or  to turn page.</p>
3	Setting menu	Includes six configurations through which you can configure camera settings, network settings, storage settings, system settings, account settings, and view information.
4	Live	Click  to go to the live view screen.
5		When you point to  , the current user account is displayed.
6		Click  , select Logout , Reboot , or Shutdown according to your actual situation.
7		<p>Displays Cell Phone Client and Device SN QR Code.</p> <ul style="list-style-type: none"> ● Cell Phone Client: Use your mobile phone to scan the QR code to add the device into the Cell Phone Client, and then you can start accessing the Device from your cell phone. ● Device SN: Obtain the Device SN by scanning the QR code. Go to the P2P management platform and add the Device SN into the platform. Then you can access and manage the device in the WAN. For details, refer to the P2P operation manual. You can also configure P2P function in the local configurations. See "5.1.4.5 Configuring P2P Settings".

5.4 Controlling PTZ Cameras

PTZ is a mechanical platform that carries a camera and a protective cover and performs overall control remotely. A PTZ can move in both horizontal and vertical direction to provide all-around view to the camera.



Before operating PTZ, ensure the network connection between PTZ and the Device.

5.4.1 Configuring PTZ Connection Settings

You need to configure the PTZ connection settings before use.

- Local connection: RS-485 Port for connecting speed dome or coaxial cable for connecting coaxial camera.
- Remote connection: local area network.

Step 1 Select **Main Menu > CAMERA > PTZ**.

Figure 5-61 PTZ

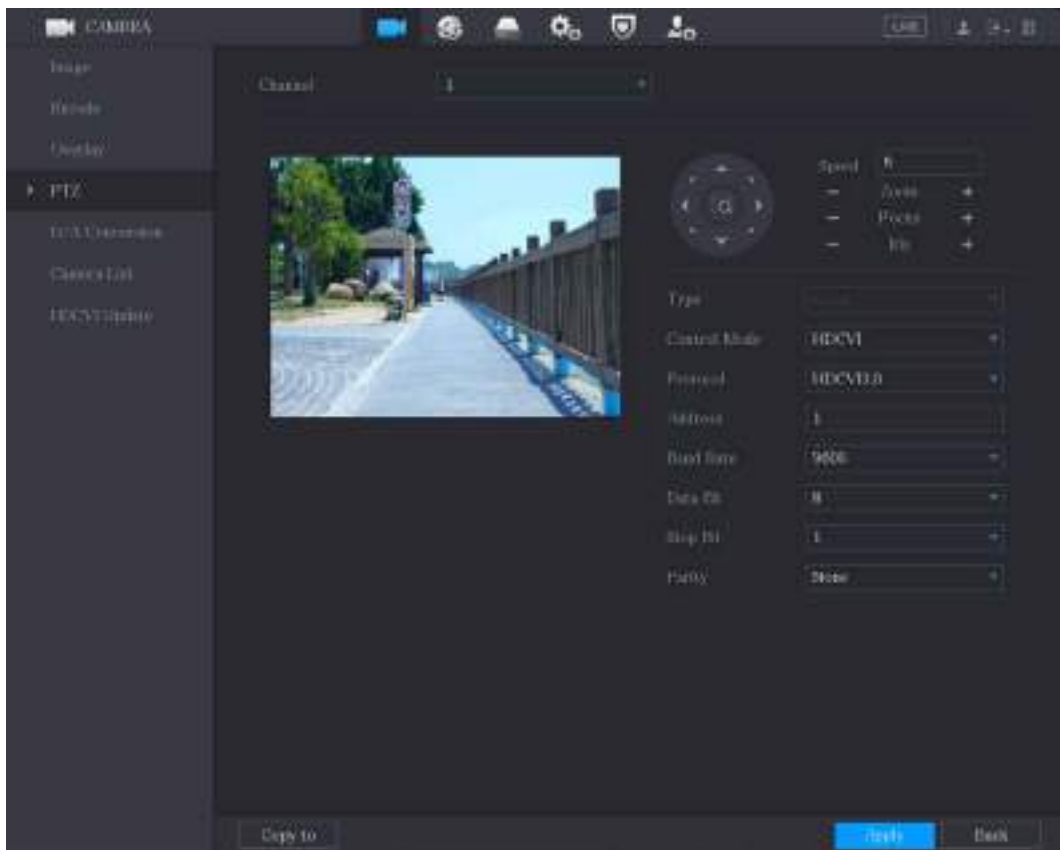

Step 2 Configure the settings for the PTZ connection parameters.

Table 5-17 PTZ connection parameters

Parameter	Description
Channel	In the Channel list, select the channel that you want to connect the PTZ camera to.
Type	<ul style="list-style-type: none"> • Local: Connect through RS-485 port or coaxial cable.

Parameter	Description
	<ul style="list-style-type: none"> Remote: Connect through network by adding IP address of PTZ camera to the Device.
Control Mode	In the Control Mode list, select Serial Port or HDCVI . For HDCVI series product, select HDCVI . The control signal is sent to the PTZ through the coaxial cable. For the serial mode, the control signal is sent to the PTZ through the RS-485 port.
Protocol	In the Protocol list, select the protocol for the PTZ camera. For example, select HDCVI3.0 .
Address	In the Address box, enter the address for PTZ camera. The default is 1.  The entered address must be the same with the address configured on the PTZ camera; otherwise the PTZ camera cannot be controlled from the Device.
Baud Rate	In the Baud Rate list, select the baud rate for the PTZ camera. The default is 9600.
Data Bits	The default value is 8.
Stop Bits	The default value is 1.
Parity	The default value is NONE.

Step 3 Click **Apply** to save the settings.



Click **Copy** to copy the settings to other channels.

5.4.2 Working with PTZ Control Panel

PTZ control panel performs the operations such as directing camera in eight directions, adjusting zoom, focus and iris settings, and quick positioning.

Basic PTZ Control Panel

Right-click on the live view screen and then select **PTZ**. The PTZ control panel is displayed.

Figure 5-62 PTZ control panel

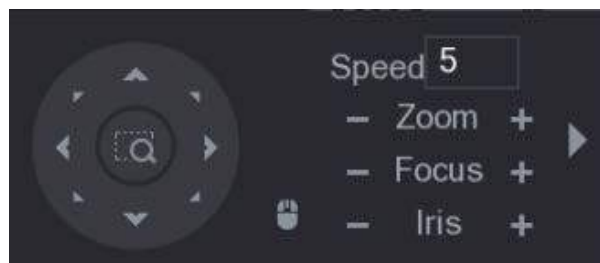

The functions with buttons in gray are not supported by the system.

Table 5-18 PTZ control panel description

Parameter	Description
Speed	Controls the movement speed. The bigger the value is, the faster the movement will be.
Zoom	: Zoom out. : Zoom in.
Focus	: Focus far. : Focus near.
Iris	: Image darker. : Image brighter.
PTZ movement	Supports eight directions.
	Fast positioning button. <ul style="list-style-type: none"> Positioning: Click to enter the fast positioning screen, and then click anywhere on the live view screen, the PTZ will turn to this point and move it to the middle of the screen. Zooming: On the fast positioning screen, drag to draw a square on the view. The square supports zooming. <ul style="list-style-type: none"> ◇ Dragging upward is to zoom out, and dragging downward is to zoom in. ◇ The smaller the square, the larger the zoom effect. <p>Not all models support this function and can only be controlled through mouse operations.</p>
	Click , you can control the four directions (left, right, up, and down) PTZ movement through mouse operation.
	Click to open the expanded PTZ control panel.

Expanded PTZ Control Panel

On the basic PTZ control panel, click to open the expanded PTZ control panel to find more options.

Figure 5-63 Expanded PTZ control panel



- The functions with buttons in gray are not supported by the system.
- Right-click once to return to the page of PTZ basic control panel.

Figure 5-64 Expanded PTZ control panel description

Icon	Function	Icon	Function
	Preset		Pan
	Tour		Flip
	Pattern		Reset
	Scan		Click the Auxiliary Config icon to open the PTZ functions settings page.
	Auxiliary		Click the Enter Menu icon to open the MENU OPERATION page.

5.4.3 Configuring PTZ Functions

5.4.3.1 Configuring Presets

Step 1 On the expanded PTZ control panel, click

Figure 5-65 Preset

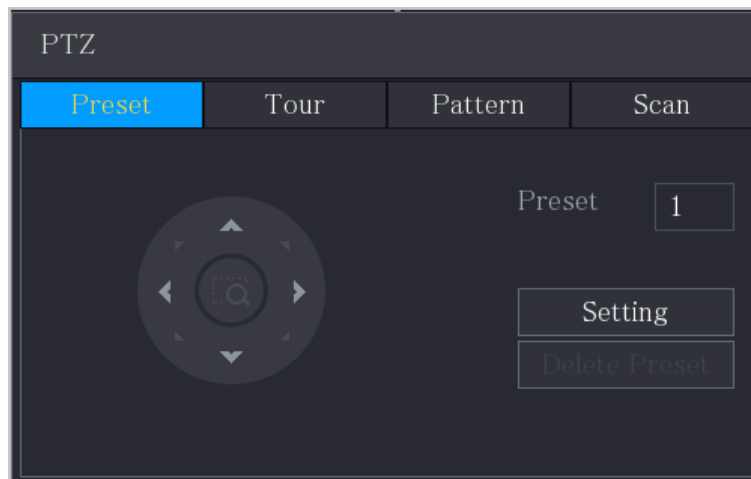

- Step 2** Click the direction arrows to the required position.
- Step 3** In the **Preset** box, enter the value to represent the required position.
- Step 4** Click **Setting** to complete the preset settings.

5.4.3.2 Configuring Tours

- Step 1** On the expanded PTZ control panel, click .
- Step 2** Click the **Tour** tab.

Figure 5-66 Tour



- Step 3** In the **Tour No.** box, enter the value for the tour route.
- Step 4** In the **Preset** box, enter the preset value.
- Step 5** Click **Add Preset**.

A preset will be added for this tour.

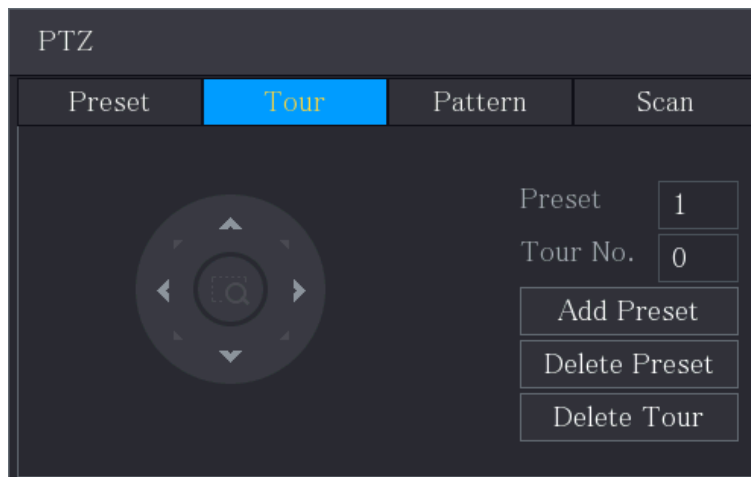

- You can repeat adding more presets.
- Click **Delete Preset** to delete the preset for this tour. This operation can be repeated to delete more presets. Some protocols do not support deleting.

5.4.3.3 Configuring Patterns

Step 1 On the expanded PTZ control panel, click .

Step 2 Click the **Pattern** tab.

Figure 5-67 Pattern

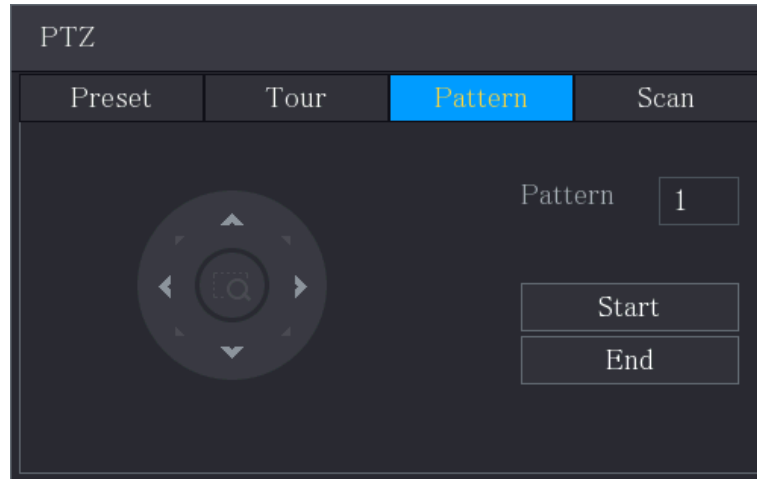

Step 3 In the **Pattern** box, enter the value for pattern.

Step 4 Click **Start** to perform the directions operations. You can also go to the PTZ Control Panel to perform the operations of adjusting zoom, focus, iris, and directions.

Step 5 On the PTZ page, click **End** to complete the settings.

5.4.3.4 Configuring Scan

Step 1 On the expanded PTZ control panel, click .

Step 2 Click the **Scan** tab.

Figure 5-68 Scan

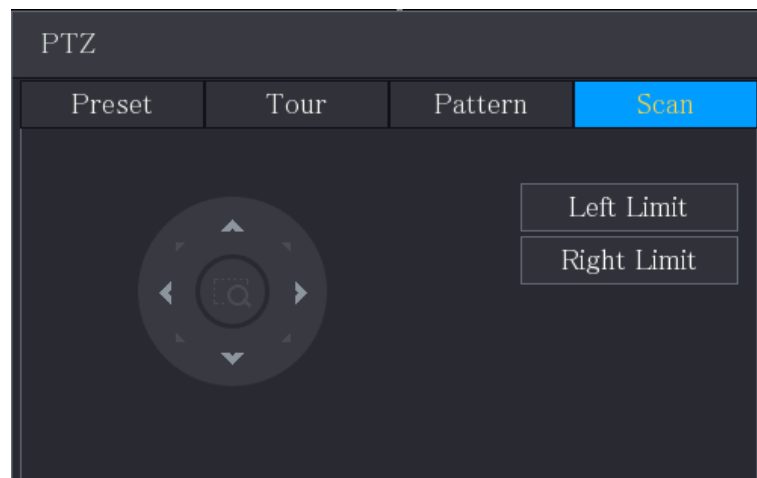

Step 3 Click the direction arrows to position the left and right limits.

5.4.4 Calling PTZ Functions

After you have configured the PTZ settings, you can call the PTZ functions for monitoring from the expanded PTZ control panel.

Figure 5-69 Expanded PTZ control panel



5.4.4.1 Calling Presets

Step 1 On the expanded PTZ Control Panel, in the **No.** box, enter the value of the preset that you want to call.

Step 2 Click  to call the preset.

Step 3 Click  again to stop calling the preset.

5.4.4.2 Calling Tours

Step 1 On the expanded PTZ control panel, in the **No.** box, enter the value of the tour that you want to call.

Step 2 Click  to call the tour.

Step 3 Click  again to stop calling the tour.

5.4.4.3 Calling Patterns

Step 1 On the expanded PTZ control panel, in the **No.** box, enter the value of the pattern that you want to call.

Step 2 Call  to call the pattern.

The PTZ camera moves according to the configured pattern repeatedly.

Step 3 Click  again to stop calling the pattern.

5.4.4.4 Calling AutoScan

Step 1 On the expanded PTZ control panel, in the **No.** box, enter the value of the border that you want to call.

Step 2 Click .

The PTZ camera performs scanning according to the configured borders.

Step 3 Click  again to stop auto scanning.

5.4.4.5 Calling AutoPan

Step 1 On the expanded PTZ control panel, click  to start moving in horizontal direction.

Step 2 Click  again to stop moving.

5.4.4.6 Using AUX Button

On the expanded PTZ control panel, click , the AUX setting page is displayed.

- In the **Shortcut Aux** list, select the option that corresponds to the applied protocol.
- In the **Aux No.** box, enter the number that corresponds to the AUX switch on the decoder.

Figure 5-70 Auxiliary

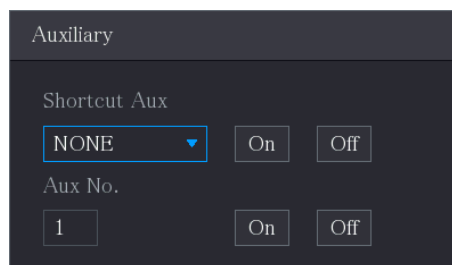

5.4.5 Calling OSD Menu

For the coaxial camera, you can call the OSD menu through the expanded PTZ control panel.

Step 1 On the expanded PTZ control panel, click .

Figure 5-71 PTZ menu



Step 2 Click **Enter**.

Figure 5-72 OSD

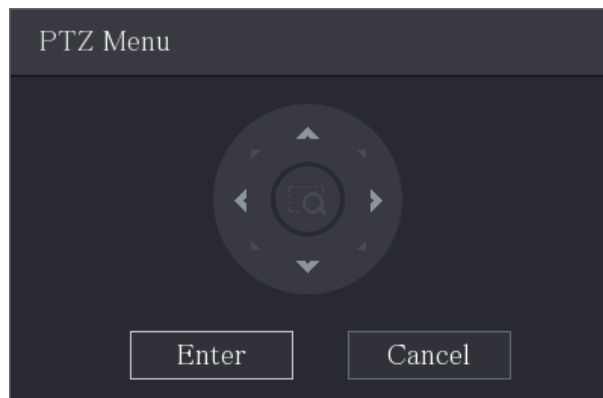

Step 3 On the **PTZ Menu** page, click the arrow button to select the onscreen parameters.

Step 4 Click **Enter** to complete the settings.

5.5 Configuring Camera Settings

5.5.1 Configuring Image Settings

You can configure the image settings such as saturation, contrast, brightness, sharpness for each connected camera.

Step 1 Select **Main Menu > CAMERA > Image**.

Figure 5-73 Analog channel

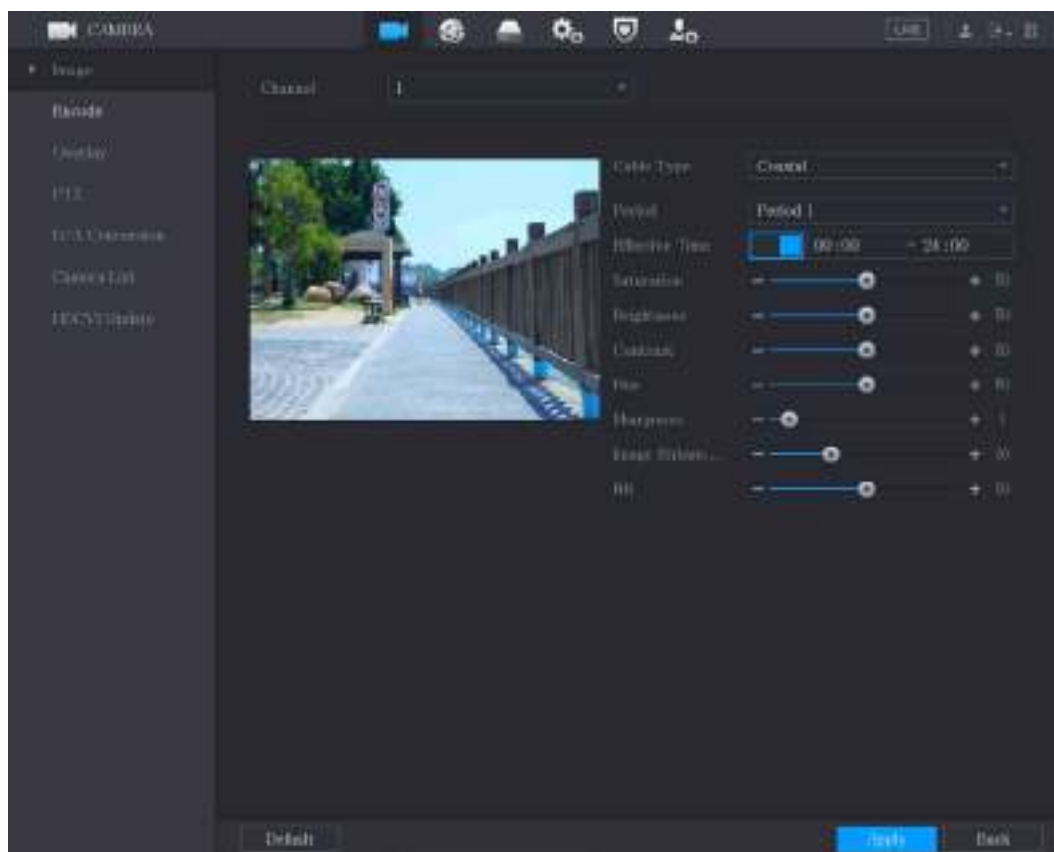
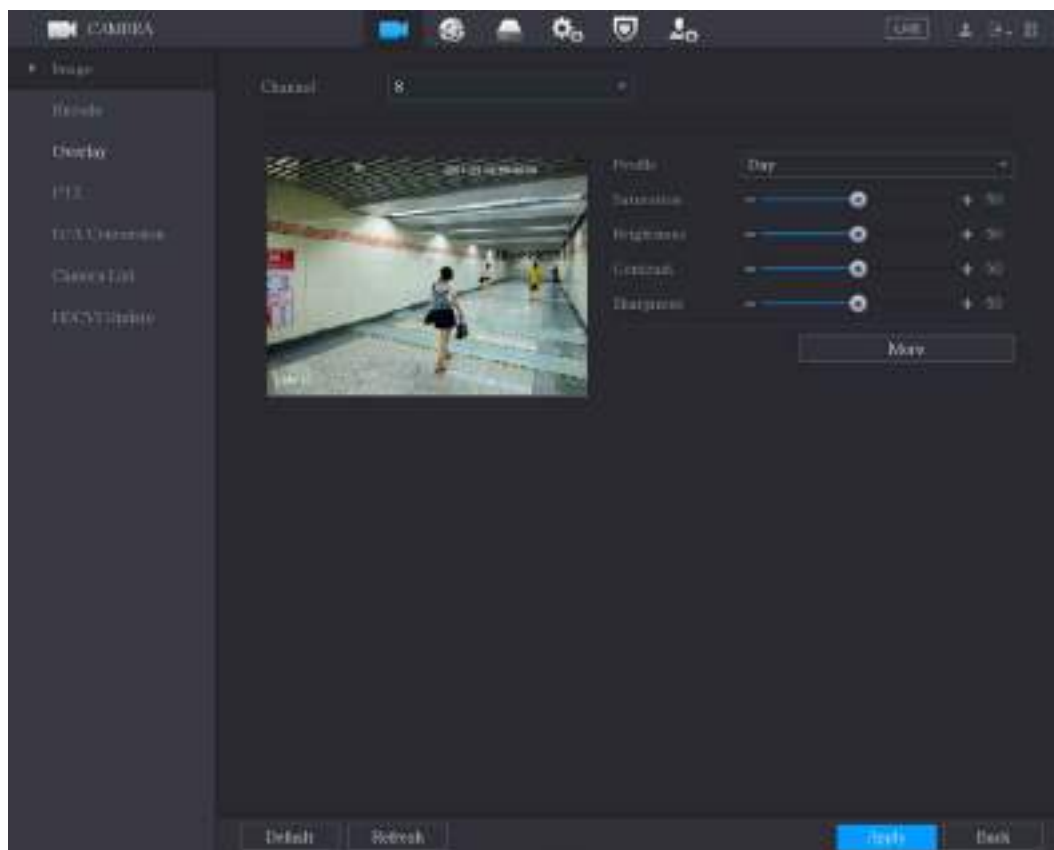



Figure 5-74 Digital channel



Step 2 Configure the settings for the image parameters.

On the digital channel page, click **More** to display more parameters.

Table 5-19 Image parameters

Parameter	Description
Channel	In the Channel list, select the channel that you want to configure.
Cable Type	In the Cable Type list, select the cable type that the camera uses.  Not all models support this function.
Period	In the Period list, select a time period for the image settings. The image settings will be only used during the selected period.
Effective Time	Enable the effective function. In the Effective Time box, enter the start time and end time for the period you selected.
Saturation	Adjusts the color shades. The bigger the value, the lighter the color will become. This value does not influence the general image lightness. The value ranges from 0 to 100. The default value is 50. The recommended range is between 40 and 60.
Contrast	Adjusts the image contrast. The bigger the value is, the more obvious the contrast between the light area and dark area will become. You can adjust this value when the contrast is not obvious. However, if the value is too big, the dark area is likely to become darker and the light area over exposed. If the value is too small, the image is likely to become dim. The value ranges from 0 to 100. The default value is 50. The recommended range is between 40 and 60.
Brightness	Adjusts the image brightness. The bigger the value is, the brighter the image will become. You can adjust this value when the image as a whole looks dark or bright. However, the image is likely to become dim if the value is too big. The value ranges from 0 to 100. The default value is 50. The recommended range is between 40 and 60.
Hue	Adjusts the hue of image. The value ranges from 0 to 100. The default value is 50.
Sharpness	Adjusts the sharpness of image edge. The bigger the value is, the more obvious the image edge, and the noise is also greater. The value ranges from 1 to 15. The default value is 1.
Image Enhance	Adjusts the image definition. The bigger the value is, the clearer the image will become, but there will be more noises.
NR	Reduces the noises from image. The bigger the value is, the better the image will become.

Parameter	Description
Config File	<p>In the Config File list, select Day, Night, Normal, or Switch By Period. The system configures the parameters correspondingly.</p> <ul style="list-style-type: none"> ● Day: Apply the configuration during daytime. ● Night: Apply the configuration during nighttime. ● Normal: Apply the configuration during day and night. ● Switch by Period: If you select this option, you need to configure the sunrise time and sunset time where you are located.
Mirror	<p>Enable the function, the left and right side of the video image will be switched. It is disabled by default.</p>
3D Denoise	<p>This function specially applies to the image which frame rate is configured as 2 at least. It reduces the noises by making use of the information between two frames. The bigger the value is, the better the effect.</p>
Flip	<p>In the Flip list, you can select 180° to change the video image display. By default, the setting is No Flip.</p>
Light	<p>In the Light list, select Close or Enable to use the backlight compensation or not.</p>
Scene Mode	<p>Configure the white balance to adjust the general hue of the image. The default setting is Auto.</p> <ul style="list-style-type: none"> ● Auto: Automatically apply white balance to different colors to make the image color display normally. ● Sunny: Apply the threshold value to sunny environment. ● Night: Apply the threshold value to night. ● Customized: Manually adjust the Red Gain and Blue Gain values.
Day & Night	<p>Configure the color and black&white mode of the image. This setting is not affected by the configuration files. The default setting is Auto.</p> <ul style="list-style-type: none"> ● Color: The camera outputs color image only. ● Auto: Depends on the camera, such as overall brightness and whether there is an IR light, either color image or black&white image is output. ● B/W: The camera outputs Black and white image only. ● By Time: The camera outputs image according to the configured sunrise time and sunset time.

Step 3 Click **Apply** to complete the settings.

5.5.2 Configuring Encode Settings

Step 1 Select **Main Menu > CAMERA > Encode > Audio/Video**.

Figure 5-75 Audio/video

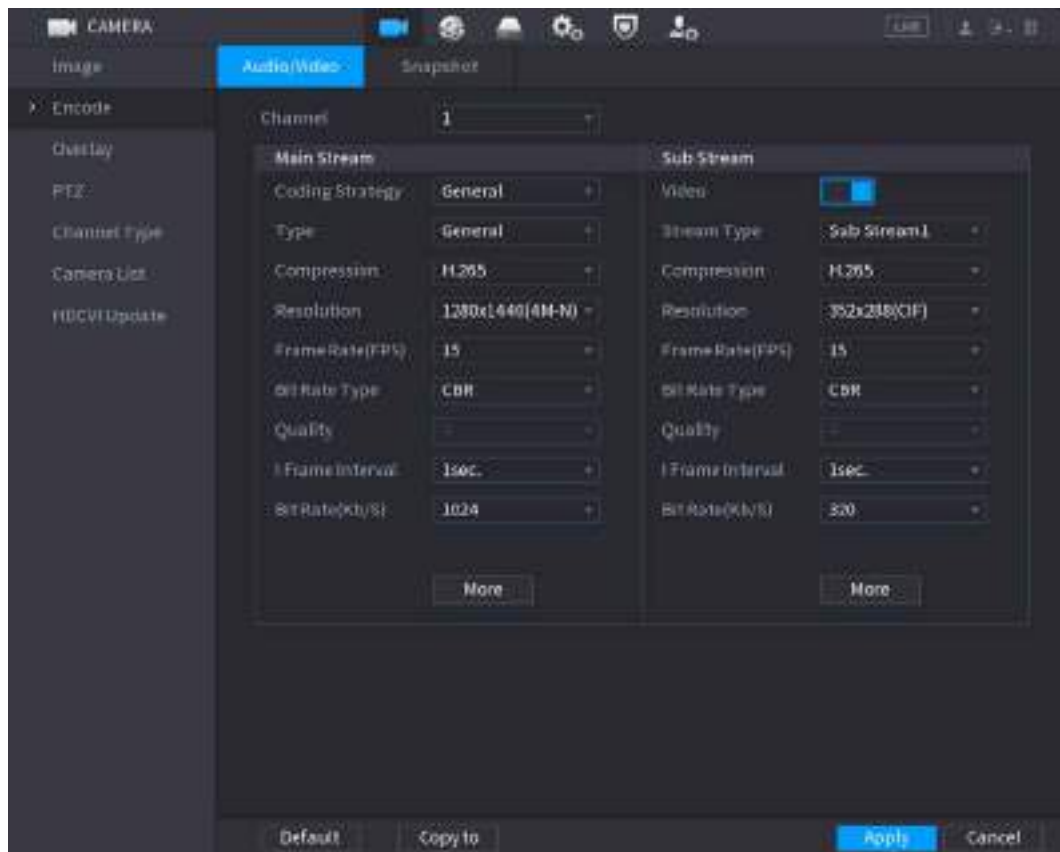

Step 2 Configure the settings for the main/sub streams parameters.

Table 5-20 Main/sub stream parameters

Parameter	Description
Channel	In the Channel list, select the channel that you want to configure the settings for.
Coding Strategy	<ul style="list-style-type: none"> ● General: Uses general coding strategy. ● Smart Codec: Enables the smart codec function. This function can reduce the video bit stream for non-important recorded video to maximize the storage space. ● AI Codec: Enables the AI codec function. This function can reduce the video bit stream for non-important recorded video to maximize the storage space.
Type	<ul style="list-style-type: none"> ● Main Stream: In the Type list, select General, Motion, or Alarm. ● Sub Stream: This setting is not configurable.
Compression	In the Compression list, select the encode mode. <ul style="list-style-type: none"> ● H.265: Main profile encoding. This setting is recommended. ● H.264H: High profile encoding. Low bit stream with high definition. ● H.264: General profile encoding. ● H.264B: Baseline profile encoding. This setting requires higher bit stream compared with other settings for the same definition.
Resolution	In the Resolution list, select resolution for the video. The maximum video resolution might be different dependent on your device model.

Parameter	Description
Frame Rate (FPS)	<p>Configure the frames per second for the video. The higher the value, the clearer and smoother the image will become. Frame rate changes along with the resolution.</p> <p>Generally, in PAL format, you can select the value from 1 through 25; in NTSC format, you can select the value from 1 through 30. However, the specific range of frame rate that you can select depends on the capability of the Device.</p>
Quality	<p>This function is available if you select VBR in the Bit Rate List.</p> <p>The higher the value, the better the image will become.</p>
I Frame Interval	The interval between two reference frames.
Bit Rate (Kb/S)	In the Bit Rate list, select a value or enter a customized value to change the image quality. The bigger the value is, the better the image will become.
Video	Enable the function for sub stream.
Audio	<p>Click More, the More page is displayed.</p> <ul style="list-style-type: none"> ● Audio: This function is enabled by default for main stream. You need to manually enable it for sub stream 1. Once this function is enabled, the recorded video file is composite audio and video stream. ● Audio Source: In the Audio Source list, you can select LOCAL and HDCVI. <ul style="list-style-type: none"> ◇ LOCAL: The audio signal is input from Audio input port. ◇ HDCVI: The audio signal is input from HDCVI camera. ● Audio Format: In the Compression list, select a format that you need.
Audio Source	
Compression	

Step 3 Click **Apply** to complete the settings.



Click **Copy** to copy the settings to other channels.

5.5.3 Configuring Snapshot Settings

Step 1 Select **Main Menu > CAMERA > Encode > Snapshot**.

Figure 5-76 Snapshot

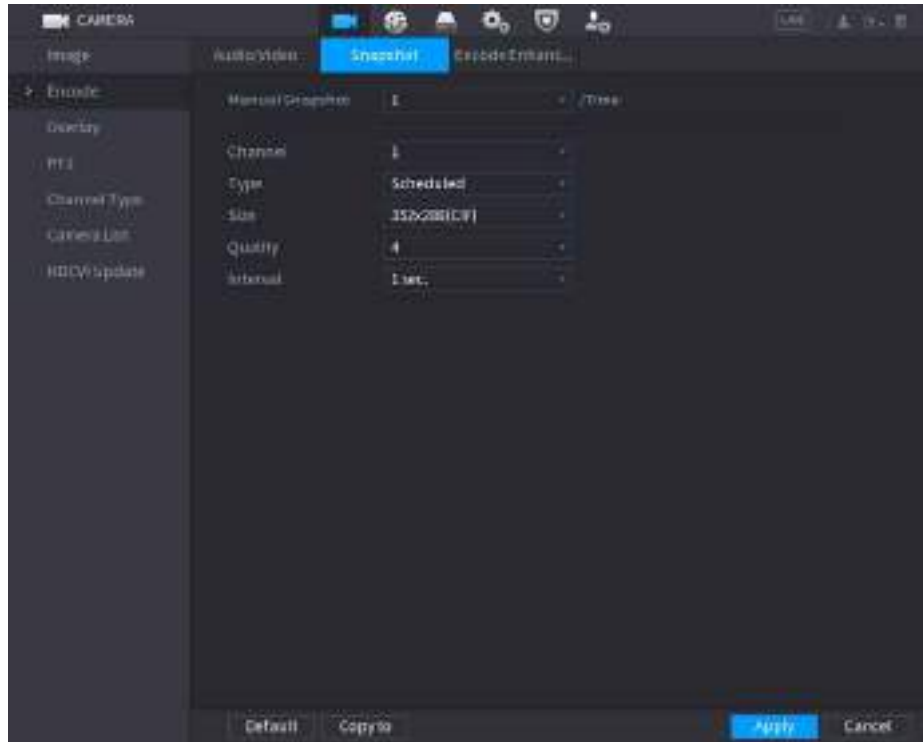

Step 2 Configure the settings for the snapshot parameters.

Table 5-21 Snapshot parameters

Parameter	Description
Manual Snapshot	In the Manual Snapshot list, select how many snapshots you want to take each time.
Channel	In the Channel list, select the channel that you want to configure the settings for.
Type	In the Type list, you can select Scheduled , Event , or Face Snapshot as the event type for which you want to take a snapshot. <ul style="list-style-type: none"> ● Scheduled: The snapshot is taken during the scheduled period. ● Event: The snapshot is taken when there is an alarm event occurs, such as motion detection event, video loss, and local alarms. ● Face Snapshot: The snapshot is taken when the face is detected. The face detection function is support only with the Channel 1.
Size	In the Size list, select a value for the image. The bigger the value is, the better the image will become.
Quality	Configures the image quality by 6 levels. The higher the level, the better the image will become.
Interval	Configures or customizes the snapshot frequency. You can select 1 second per one snapshot to 7 seconds per one snapshot. The maximum is 3600 seconds per one snapshot.

Step 3 Click **Apply** to complete the settings.



Click **Copy to** to copy the settings to other channels.

5.5.4 Configuring Encode Enhancement

You can enable this function and get more FPS in encode settings (see "5.5.2 Configuring Encode Settings"). In the meantime, you will not be able to use extra screen function (see "5.2.8.1 Configuring Display Settings") and AI functions (see "5.11 AI Function").

Select **Main Menu > CAMERA > Encode > Encode Enhancement**.

Figure 5-77 Encode enhancement

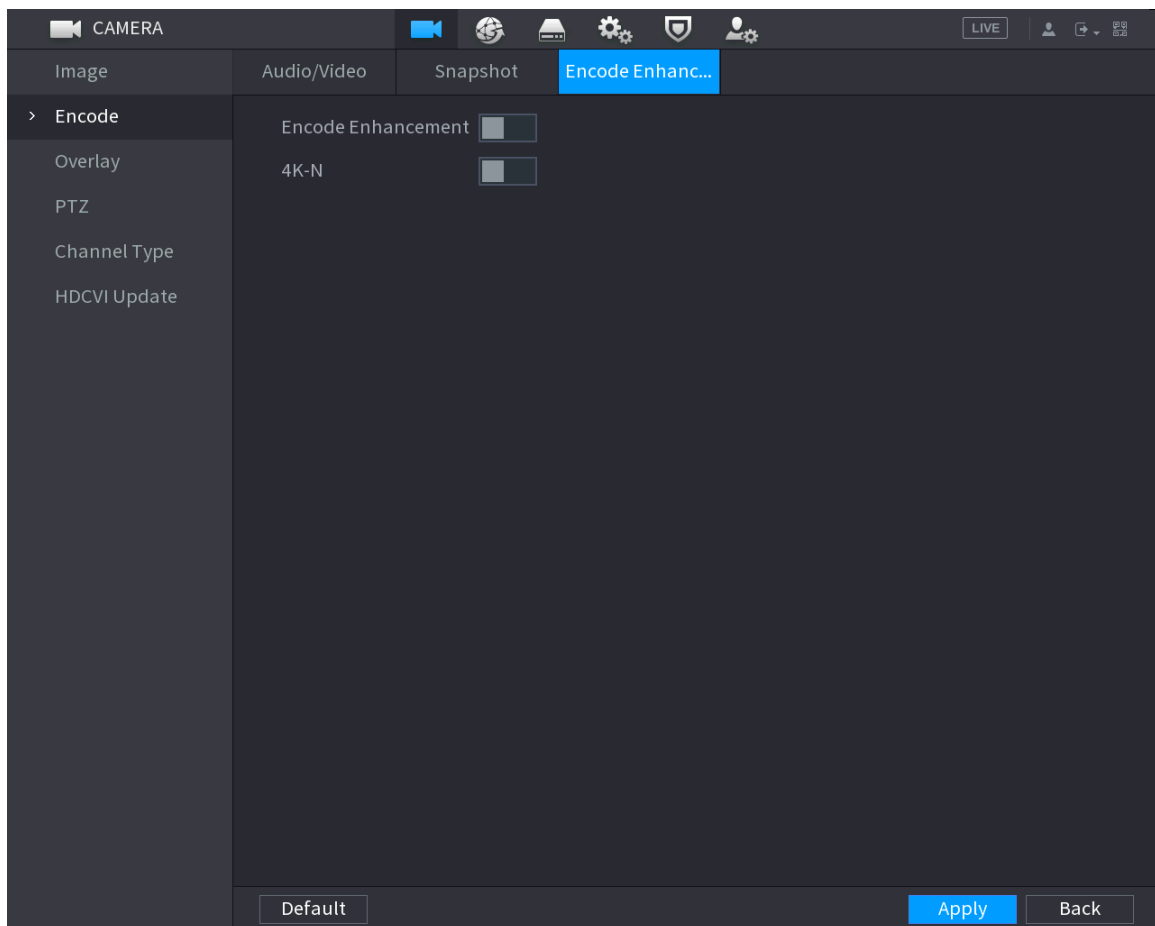

Click the switch to enable it.

When connecting to the new generation 4K cameras, you can enable **4K-N** to switch 4K non-live view to 4K-N live view and encoding.

5.5.5 Configuring Overlay Settings

You can configure to display system time and channel name on each channel window in the live view screen.

Step 1 Select **Main Menu > CAMERA > Overlay > Overlay**.

Figure 5-78 Overlay

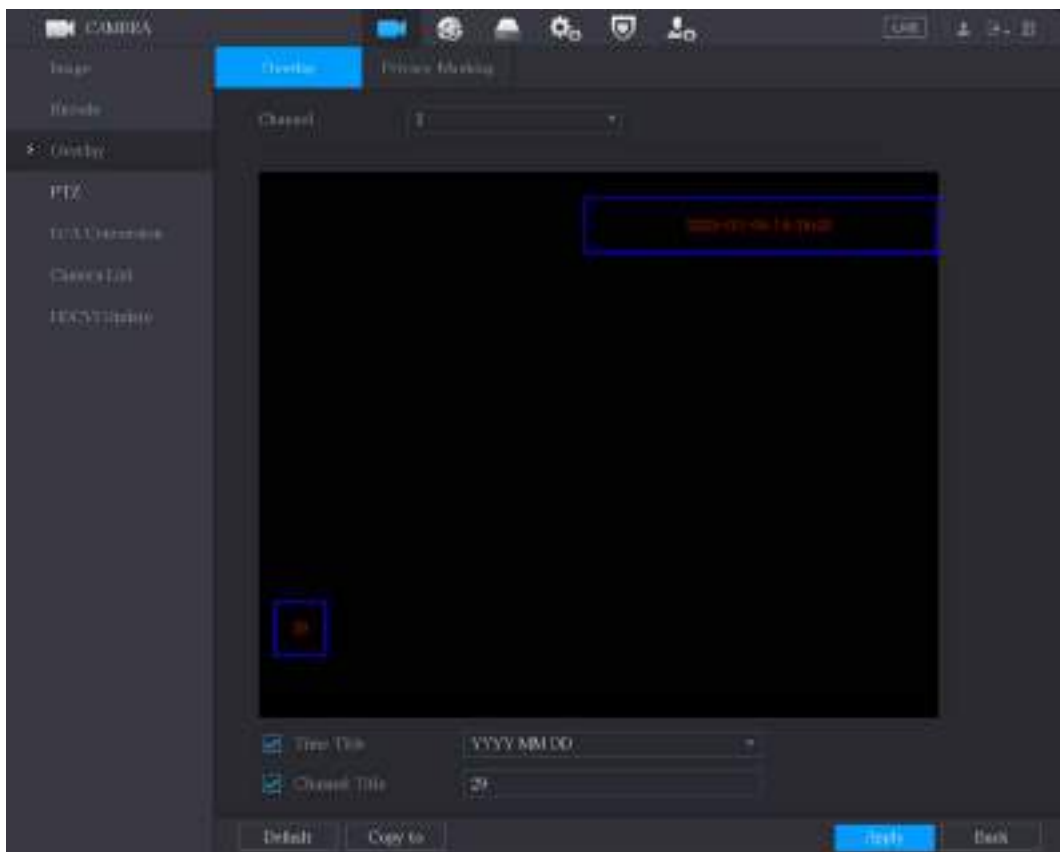

Step 2 Configure the settings for the text overlay parameters.

Table 5-22 Overlay parameters

Parameter	Description
Channel	In the Channel list, select the channel that you want to configure the settings for.
Time Title	Select the Time Title checkbox to display the system time on each channel window in the live view screen. In the Time Title list, select time display style.
Channel Title	Select the Channel Title checkbox to display the channel name on each channel window in the live view screen. In the Channel Title box, enter the name for the selected channel.

Step 3 Click **Apply** to complete the settings.



Click **Copy to** to copy the settings to other channels.

5.5.6 Configuring Covered Area Settings

Step 1 Select **Main Menu > CAMERA > Overlay > Privacy Masking**.

Figure 5-79 Privacy masking

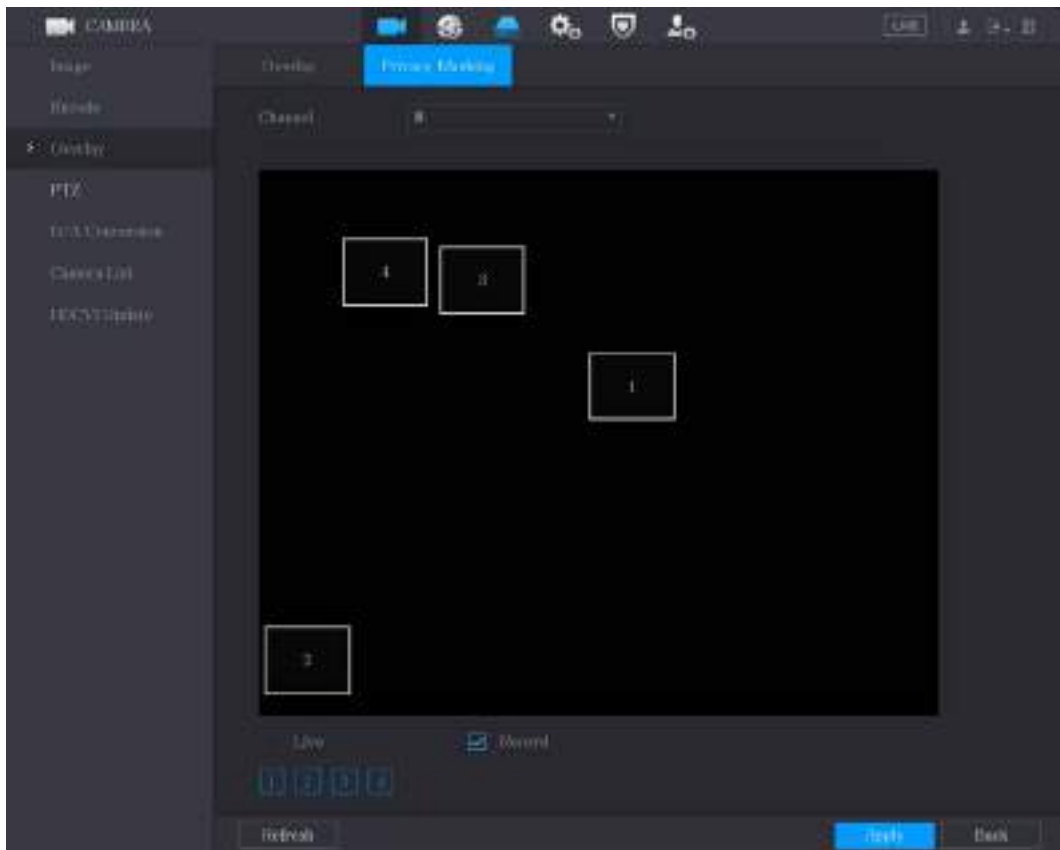

Step 2 Configure the settings for the covered area parameters.

Figure 5-80 Covered area parameters

Parameter	Description
Channel	In the Channel list, select the channel that you want to configure the settings for.
Live	<ul style="list-style-type: none"> Preview: Select the Live checkbox to apply the configured covered block to the selected channel window in the live view screen. Record: Select the Record checkbox to apply the configured covered block to the selected channel window during recording.
Record	To configure covering block, do the following: <ol style="list-style-type: none"> Select the Live checkbox or the Record checkbox, or select the both. The "1, 2, 3, 4" buttons are activated. Click the buttons to select blocks. A triangle solid black block is displayed. Drag the block to the area that you want to cover and adjust the size of the block. You can configure total 4 covered blocks.

Step 3 Click **Apply** to complete the settings.

5.5.7 Configuring Channel Type

You can configure the channel type as **Analog** or **IP** channel.

Step 1 Select **Main Menu > CAMERA > Channel Type**.

Figure 5-81 Channel type

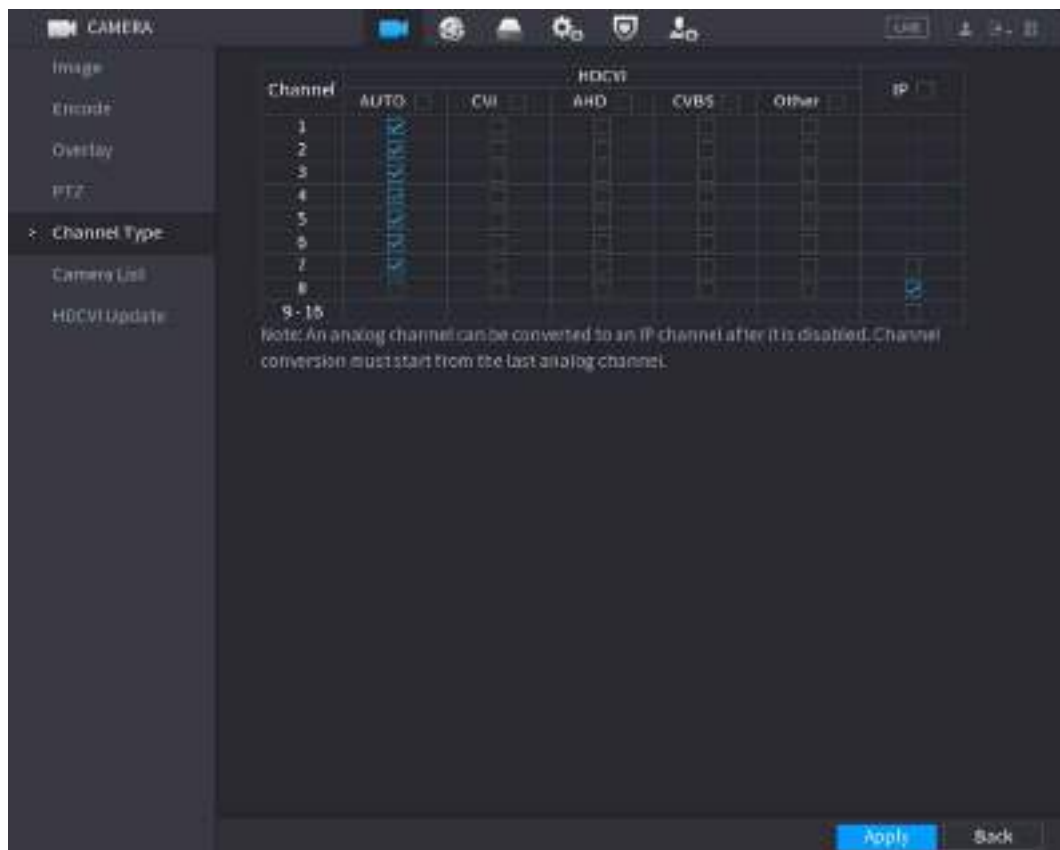

Step 2 Configure the channels.

- Analog Channel: Select the transmission medium such as CVI, AHD, CVBS, and then follow the onscreen instructions to complete the settings.
- IP Channel: You can enable the IP channels by disabling the corresponding analog channels. The Device also provides expanded IP channels for your use, such as the 17–64 channels in 0.



- The 17–64 channels are only for IP camera and the range changes dependent on the model you purchased.
- The channel selection for analog camera or IP camera are in sequence, for example, if you want to select channels for IP camera, you need to select from the last channel number Channel 16 first, which means, you cannot go to select the channel 15 directly until you have selected the channel 16.

Step 3 Click **Apply** and follow the onscreen instructions to complete the settings.

5.5.8 Upgrading Coaxial Camera

Step 1 Select Main Menu > CAMERA > HDVCI Update.

Figure 5-82 Update

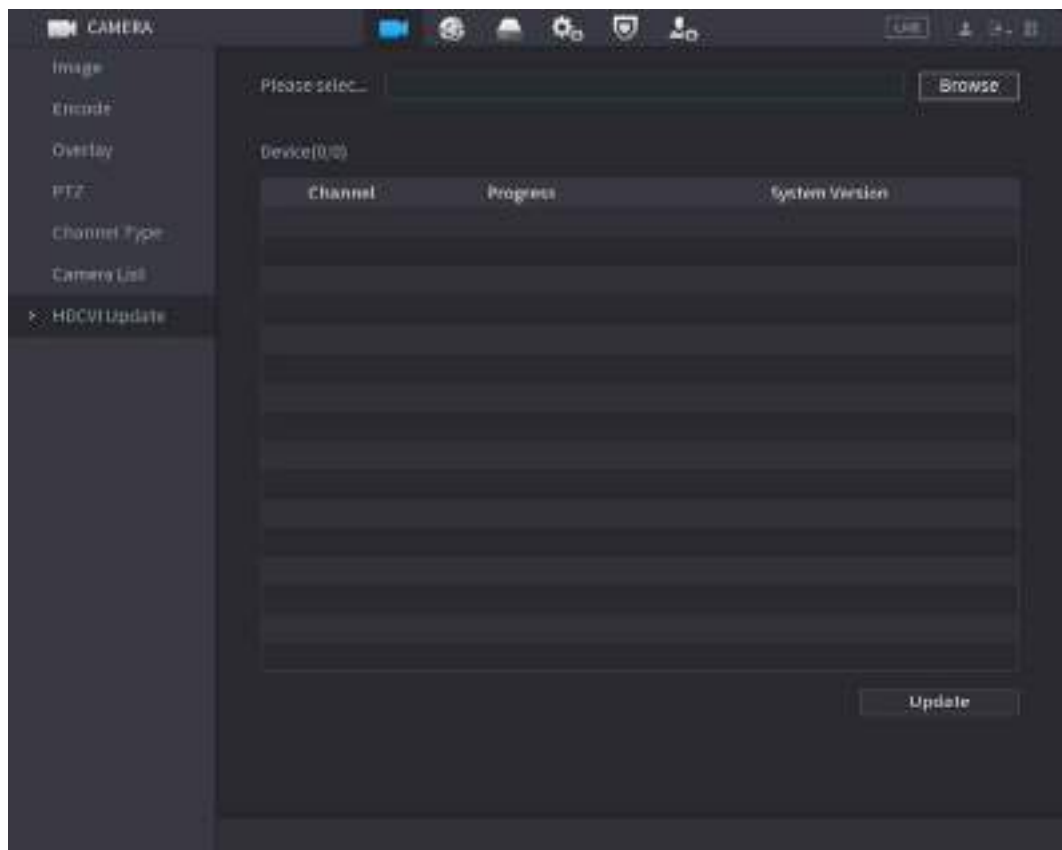

Step 2 Click **Browse**.

Step 3 Select the upgrade file and then click **OK**.



You need to insert the USB storage device that contains the upgrading files.

Step 4 Select the checkbox of the channel that you want to upgrade.

Step 5 Click **Update**.

If the upgrading is successful, the system pops up a message indicating the upgrading is completed.

5.6 Configuring Remote Devices

5.6.1 Adding Remote Devices



This function is available after you have configured the channel type as IP channel as described in previous section, see "5.5.7 Configuring Channel Type".

You can add remote devices by adding the IP address.

Select **Main Menu > CAMERA > Camera List > Add Camera**, the **Add Camera** page is displayed.

Figure 5-83 Add camera

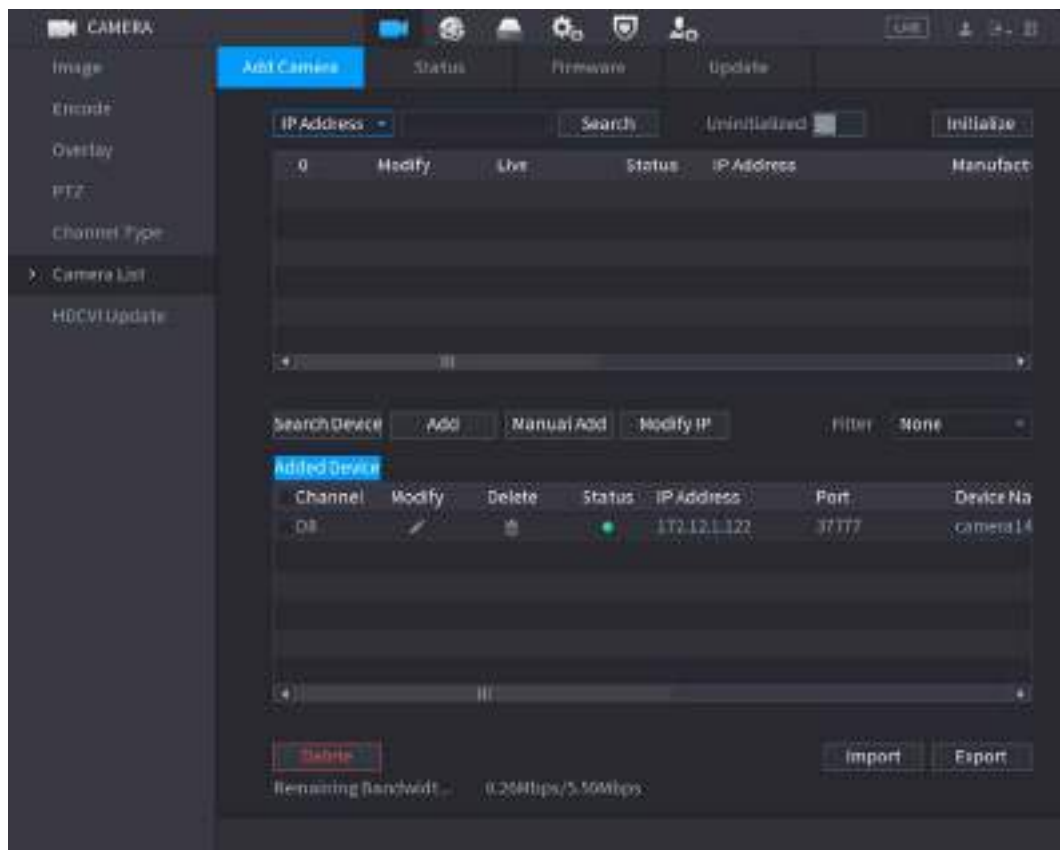



Table 5-23 Parameters

Parameter	Description
Uninitialized	Enable the Uninitialized function, the uninitialized devices out of the searched devices are displayed in the searched device list.
Initialize	Select the uninitialized device from the uninitialized device list, and the click Initialize to start initializing device.
Filter	In the Filter list, select the remote device type that you want to display in the searched device list. <ul style="list-style-type: none"> ● None: Display all types of devices. ● IPC: Display the front-end devices. ● DVR: Display all storage devices such as NVR, DVR and HCVR. ● OTHER: Display the devices that do not belong to IPC or DVR type.
Searched Device List	Displays the searched devices. You can view the device information such as status, IP address.
Search	Click Search , the searched devices display in the searched device list. To adjust the display sequence, in the title line, you can click the IP address, Type or Device Name text. For example, click the IP address text, the sequence icon  is displayed.  "*" is displayed next to the added device.
Add	In the Searched Device List area, select the device that you want to add.

Parameter	Description
Manual Add	Add the device by manually configuring settings such as IP address, channel selection. For details, see "5.6.1.3 Adding Remote Devices Manually".
Added Device List	Displays the added devices. You can edit and delete the device, and view the device information.
Delete	Select the checkbox of the added device, and then click Delete to delete the added device.
Import	Select the searched devices and then click Import to import the devices in batches.
Export	Select the added devices and then click Export . The exported devices information is saved into the USB storage device.

5.6.1.1 Initializing Remote Devices

You can reset the password and IP address of the remote devices through initializing.

Step 1 Click **Search Device**.

The devices found are displayed in the table.

Figure 5-84 Search result

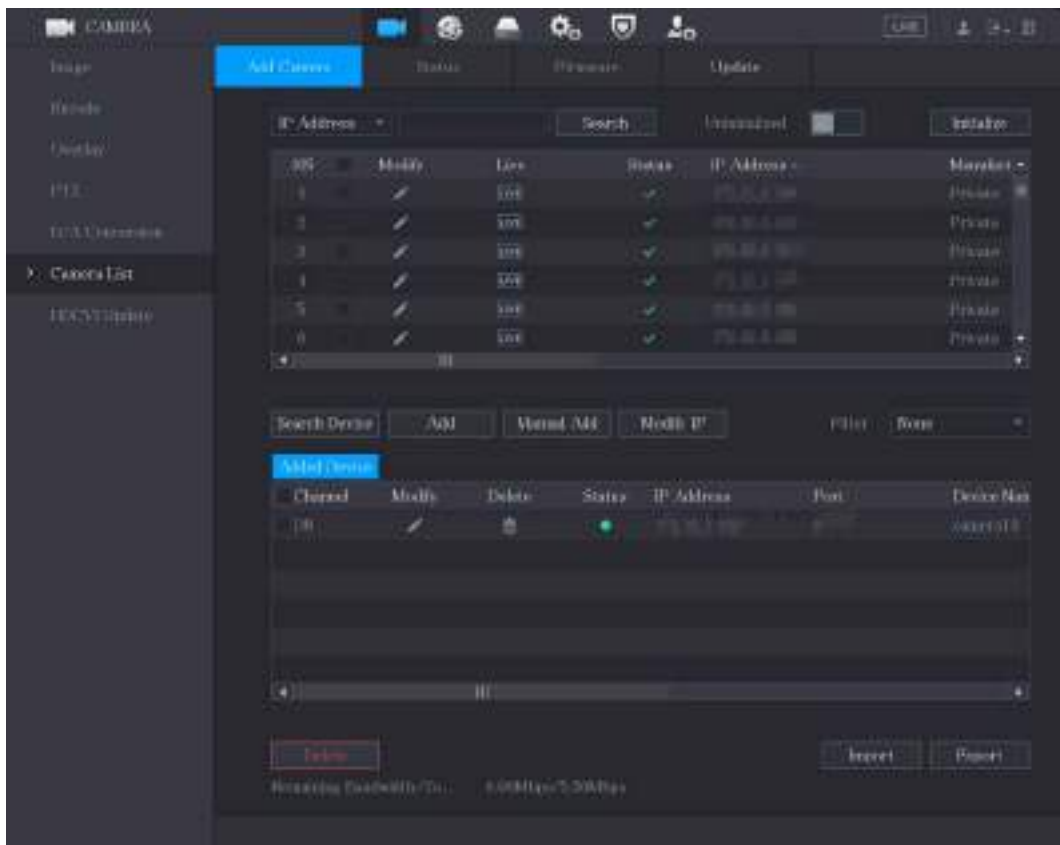

Step 2 Enable the Initialized function.

The uninitialized devices are displayed.

Figure 5-85 Uninitialized devices

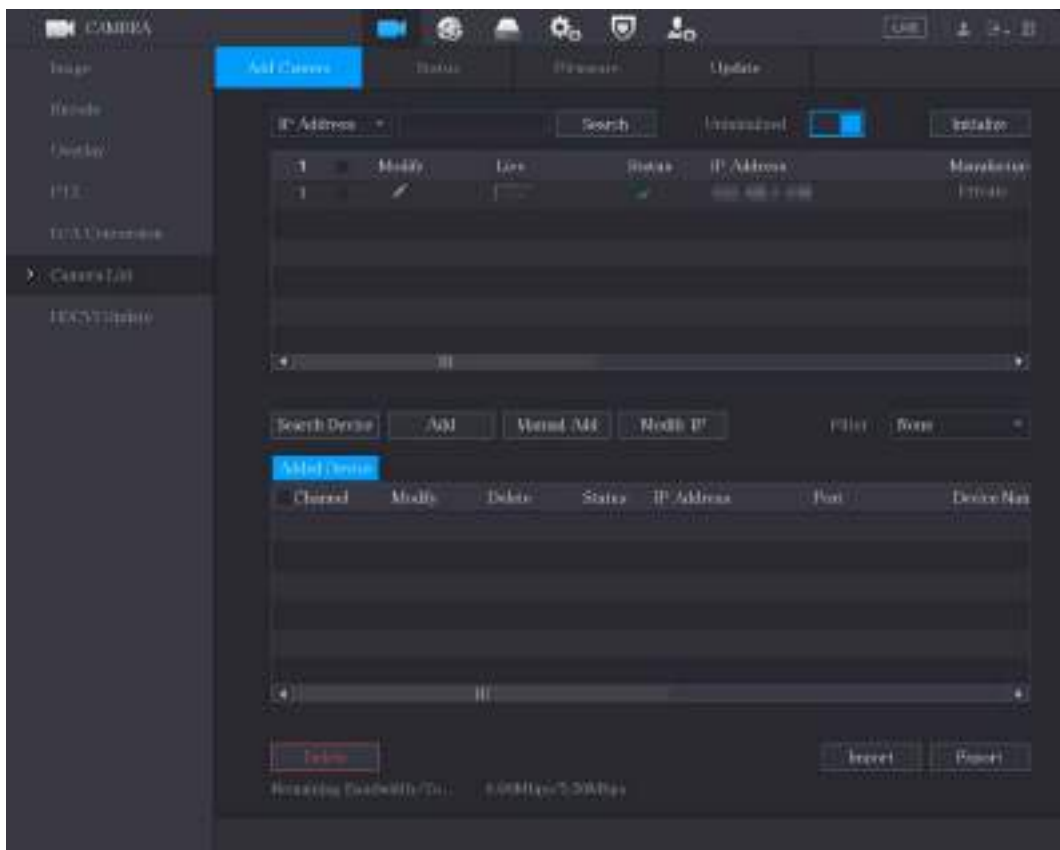

Step 3 Select the uninitialized device that you want to initialize.

Step 4 Click **Initialize**.

Figure 5-86 Enter password

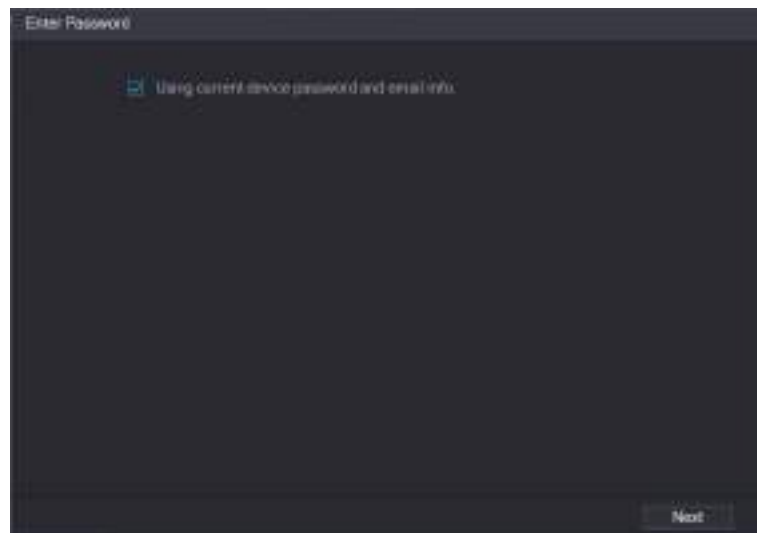

Step 5 Configure the password and email information.



If you select the **Using current device password and email info** checkbox, the remote device automatically uses the current password and email information, so you do not need to set the password and email address again and can go to Step 6.

- 1) Clear the Using current device password and email info checkbox.

Figure 5-87 Password setting



- 2) Configure the settings for the password setting parameters.

Figure 5-88 Password parameters

Parameter	Description
User	The default is admin.
Password	The password must consist of 8–32 non-blank characters and contain at least two types of the following characters: uppercase, lowercase, numbers, and special characters (excluding ' " ; : &).
Confirm Password	Enter a strong password according to the password strength bar indication.

- 3) Click **Next**.

Figure 5-89 Password protection



- 4) Select the **Email Address** box and enter the email address that you want to reserve for password reset in the future.



If you do not want to set the reserved email address, click **Skip**.

Step 6 Click **Next**.

Figure 5-90 Network

NETWORK

Checked Device No.: 1

DHCP
 STATIC

IP Address: [192] [168] [1] [255] Incremental Value: [1]

Subnet Mask: [255] [255] [255] [0]

Default Gateway: [192] [168] [1] [1]

ID	IP Address
1	192.168.1.255

Back Next Skip

Step 7 Configure the IP address.

- Select the **DHCP** checkbox, you do not need to enter the IP address information, because the system will allocate one IP address to the remote device.
- Select the **STATIC** checkbox, you need to enter the IP address, subnet mast, default gateway, and incremental value. The system will allocate the IP address to the remote devices by progressively increasing the last part of the IP address when initializing devices in batches.



When configuring IP address for multiple remote devices which were not in the same network segment, these remote devices will belong to the same network segment after configuration.

Step 8 Click **Next**.

The initializing is started.

Figure 5-91 Initialization finished

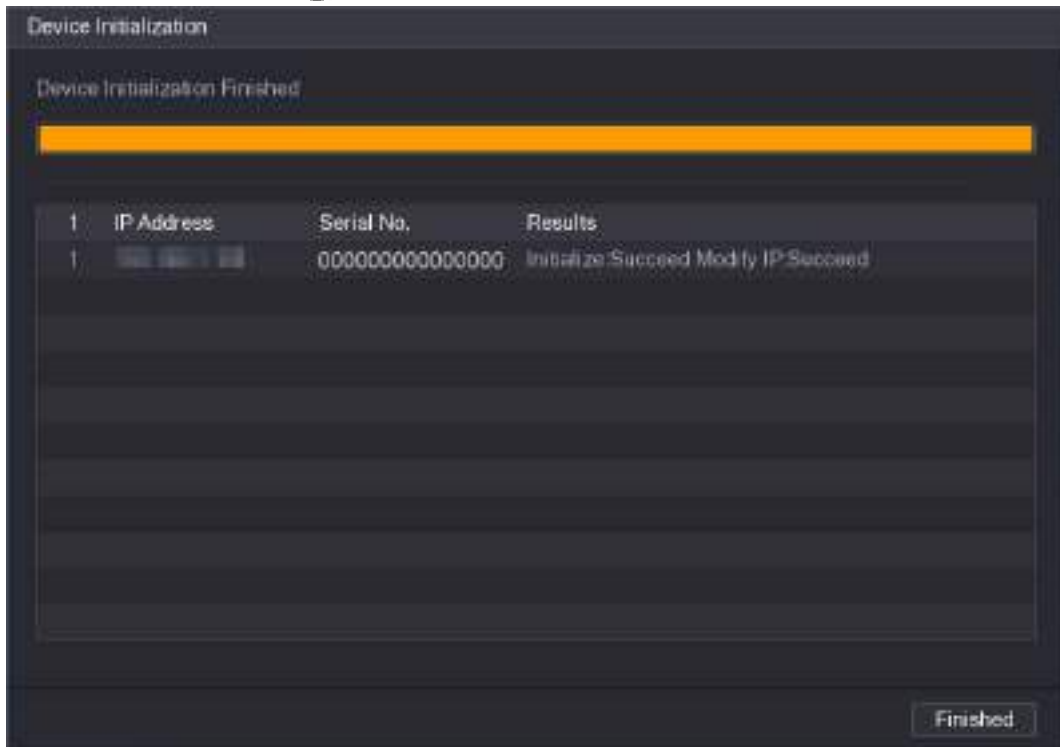

Step 9 Click **Finished** to complete the settings.

5.6.1.2 Adding Remote Devices Automatically

Step 1 On the **Registration** page, click **Device Search**
The devices found are displayed.

Figure 5-92 Search device

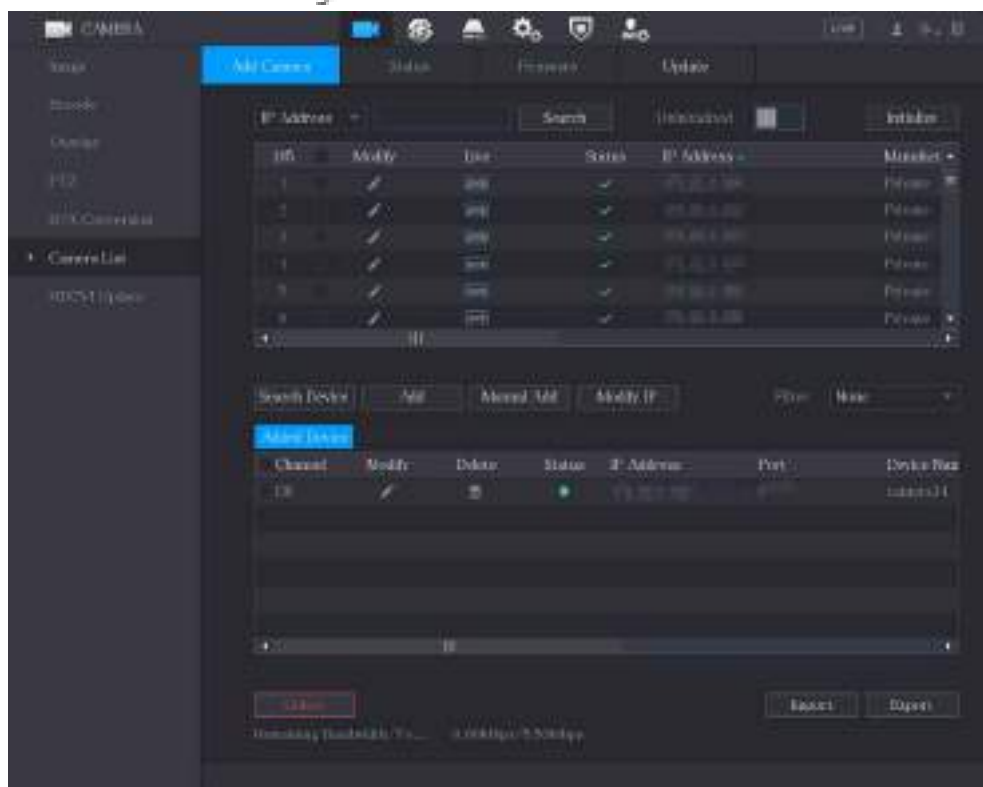

Step 2 Select the checkbox of the device.

Step 3 Click **Add**.

The device is added into the **Added Device** area.



- You can also double-click the device to add it into the **Added Device** area.
- You can add devices in batches.

5.6.1.3 Adding Remote Devices Manually

Step 1 On the **Add Camera** page, click **Manual Add**.

Figure 5-93 Manual add

Step 2 Configure the settings for the manual adding device parameters.



Figure 5-94 Manual add parameters

Parameter	Description
Channel	In the Channel list, select the channel that you want use on the Device to connect the remote device.
Manufacturer	In the Manufacturer list, select the manufacturer of the remote device.
IP Address	In the IP Address box, enter the IP address of remote device.  The default is 192.168.0.0 which the system cannot connect to.
RTSP Port	The default value setting is 554. You can enter the value according to your actual situation.
HTTP Port	The default value setting is 80. You can enter the value according to your actual situation. If you enter other value, for example, 70, and then you should enter 70 after the IP address when logging in the Device by browser.
TCP Port	The default value setting is 37777. You can enter the value according to your actual situation.

Parameter	Description
Username	Enter the username of the remote device.
Password	Enter the password of the user for the remote device.
Remote CH No.	Enter the remote channel number of the remote device that you want to add.
Decoder Strategy	In the Decoder Strategy list, select Default , Realtime , or Fluent .
Protocol Type	<ul style="list-style-type: none"> • If the remote device is added through private protocol, the default type is TCP. • If the remote device is added through ONVIF protocol, the system supports Auto, TCP, UDP, or MULTICAST. • If the remote device is added through other manufacturers, the system supports TCP and UDP.
Encryption	If the remote device is added through ONVIF protocol, enabling the Encryption checkbox will provide encryption protection to the data being transmitted.  To use this function, the HTTPS function should be enabled for the remote IP camera.

Step 3 Click **OK** to save the settings.



- Only one device can be added manually at one time.
-  indicates successful connection and  indicates connection failed.

5.6.1.4 Modifying or Deleting Remote Devices

You can modify and delete the added devices.

- To modify the remote devices, do the following:



Step 1 Click  or double-click a device.

Figure 5-95 Modify

Step 2 In the **Channel** list, select the channel that you want to modify settings for.

Step 3 Click **OK** to save the settings.

- To delete one or more added devices, do the following:
 - ◇ Click  to delete one device.
 - ◇ Select the checkbox of the devices that you want to delete, and then click **Delete**.

5.6.1.5 Modifying IP Address

You can modify a single IP address or multiple IP addresses of remote devices at one time.



You can only modify the IP address of initialized cameras.

- To modify a single IP address, do the following:

Step 1 In the Searched Device list area, click  for the device that you want to modify IP.

Figure 5-96 Modify IP

Modify IP

Selected Device Quantity: 1

DHCP
 Static

Username
 Password

IP Address
 Incremental Value

Subnet Mask

Default Gateway

1	SN	IP Address
1		

Step 2 Configure the settings for IP address, subnet mask, default gateway, username, and password.

Step 3 Click **OK** to save the settings.

- To modify IP address in batches, do the following:

Step 1 In the Searched Device list area, select the devices that you want to modify IP address in batches.

Step 2 Click

Figure 5-97 Modify IP

Modify IP

Selected Device Quantity: 4

DHCP
 Static

Username
 Password

IP Address
 Incremental Value

Subnet Mask

Default Gateway

4	SN	IP Address
1		
2		
3		
4		

Step 3 Set incremental value.



The system will add the incremental value to the fourth segment of IP addresses of selected devices.

- Step 4** Configure the settings for start IP address (the IP address is allocated in sequence), subnet mask, default gateway, username, and password.
- Step 5** Click **OK** to save the settings.

5.6.1.6 Exporting IP Address

You can export the added IP address to the USB storage device.



The exported information is saved in .csv file, which includes IP address, port number, channel number, manufacturer, username, and password.

- Step 1** Insert the USB storage device to the USB port of the Device.
- Step 2** Click **Export**.

Figure 5-98 Browse

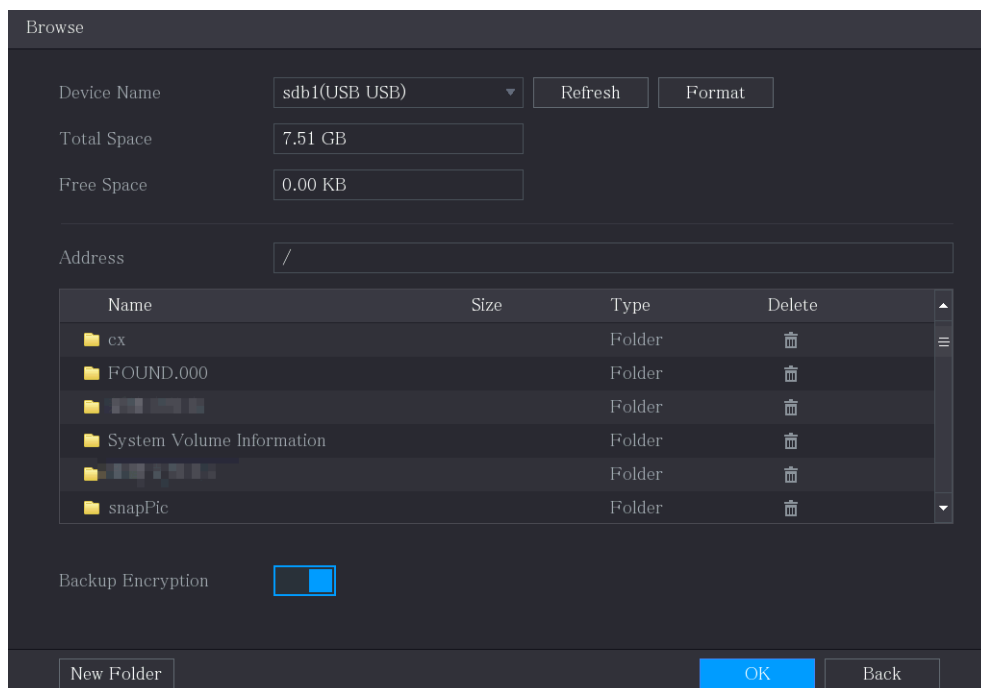

- Step 3** Configure the save path.
- Step 4** Click **OK** to save the settings.
A pop-up message indicating "Successfully exported" is displayed.
- Step 5** Click **OK**.



When exporting IP address, the **Backup Encryption** checkbox is selected by default. The file information includes IP address, port, channel number, manufacturer, username, and password.

- If you select the **Backup Encryption** checkbox, the file format is .backup.
- If you clear the **Backup Encryption** checkbox, the file format is .csv. In this case, there might be a risk of data leakage.

5.6.1.7 Importing IP Address

You can add remote devices by importing IP address information.

- Step 1** Insert the USB storage device to the USB port of the Device.
Step 2 Click **Import**.

Figure 5-99 Browse

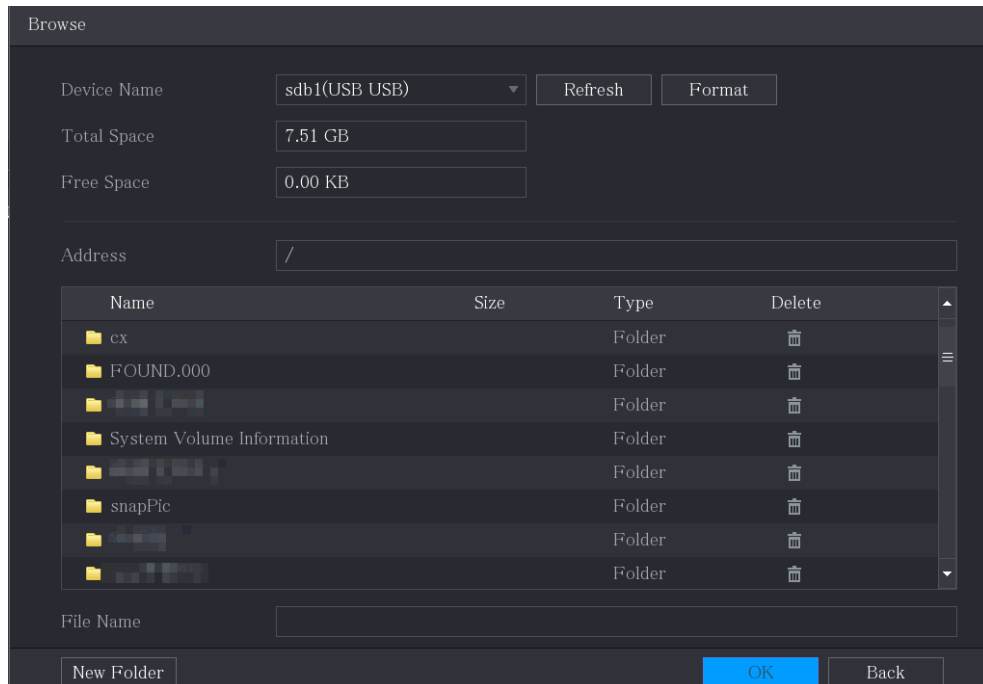

- Step 3** Select the file that you want to import.
Step 4 Click **OK** to start importing.

After importing is completed, a pop-up message indicating "The import succeeded" is displayed.



If the IP address that you want to import already exists in the Device, the system will pop up a message to ask you whether to overwrite the existing content.

- Click **OK** to replace the existing one.
- Click **Cancel** to add it as a separate device in the Added Device area.



- You can edit the exported .csv file and be cautious not to change the file format; otherwise the file cannot be imported as it will be judged as invalid.
- The language of .csv file must match the Device language.
- The import and export through customized protocol is not supported.

5.6.2 Managing Remote Devices

You can view the status of remote devices and upgrade.

5.6.2.1 Viewing Status

You can view the device information such as connection status, IP address, motion detection, video loss detection, camera name, and manufacturer.

Select **Main Menu > CAMERA > Camera List > Status**.

5.6.2.2 Viewing Firmware Information

You can view the device firmware information such as channel number, IP address, manufacturer, system version, video input, audio input, and alarm in.

Select **Main Menu > CAMERA > Camera List > Firmware**.

Figure 5-100 Firmware

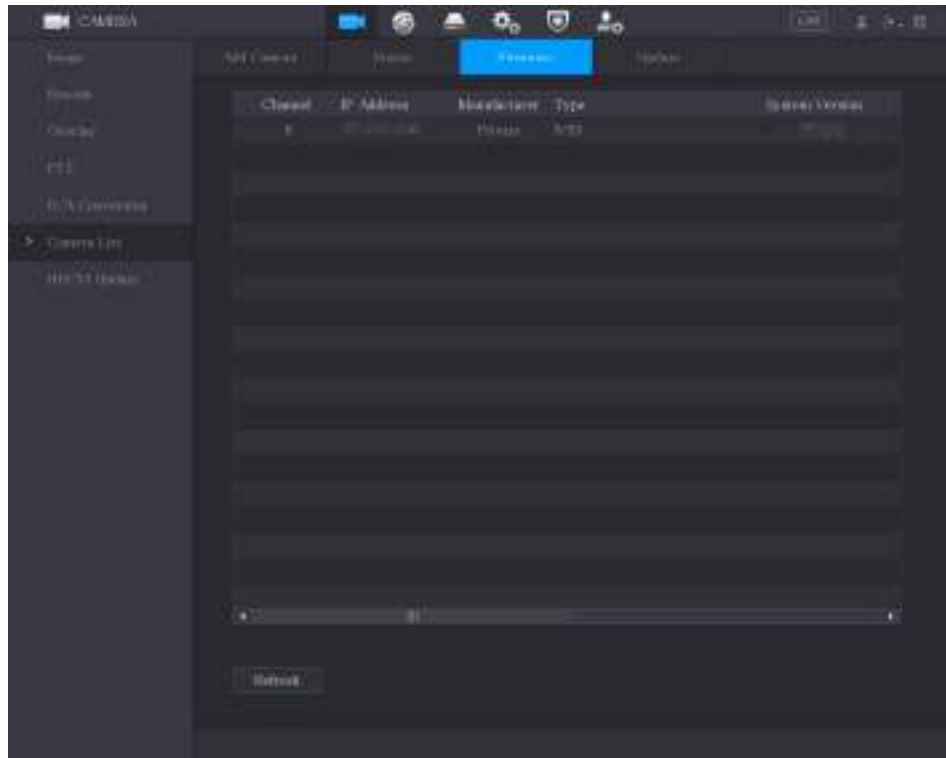

5.6.2.3 Upgrading Remote Devices

Step 1 Select **Main Menu > CAMERA > Camera List > Update**.

Figure 5-101 Update

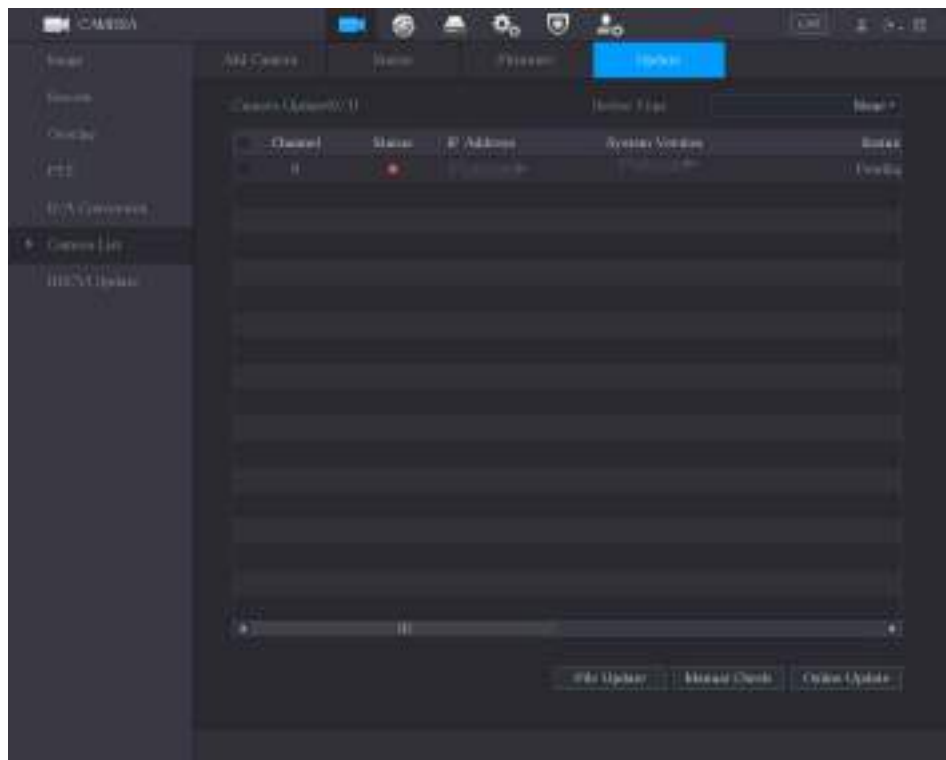

Step 2 Upgrade the device.

- File Update
 - 1) Insert a USB storage device containing the upgrade files into the USB port of the Device.
 - 2) Select the devices that you want to upgrade.
 - 3) Click File Update.
The **File Update** page is displayed.
 - 4) Select the upgrading files and click **Apply**.
- Online Update
 - 1) Click **Detect** or select the checkbox the device that you want to upgrade and click **Manual Check**.
The system starts detecting if there is a new version on the online server.
 - 2) Select the checkbox of all the devices that have new version.
 - 3) Click Online Update.



- The system will pop up a message to indicate if the upgrading is successful.
- You can use the Type list to filter the devices so that you can find the devices quickly.

5.7 Configuring Record Settings

You can record video manually or automatically and configure the recording settings to main stream and sub stream respectively.

5.7.1 Enabling Record Control



- Manual recording operation requires the user have the permission to access **STORAGE** settings.
- Check to ensure the HDD installed in the Device has been formatted properly.

To enter the record control page, do the following:

Step 1 Right-click on the live view screen, the shortcut menu is displayed. On the shortcut menu, select **Manual Control > Record Control**.

Figure 5-102 Record mode

Record Mode			1	2	3	4	5	6	7	8
Main Stream	All									
Auto	<input type="radio"/>	<input checked="" type="radio"/>	<input checked="" type="radio"/>	<input checked="" type="radio"/>	<input checked="" type="radio"/>	<input checked="" type="radio"/>	<input checked="" type="radio"/>	<input checked="" type="radio"/>	<input checked="" type="radio"/>	<input checked="" type="radio"/>
Manual	<input type="radio"/>	<input type="radio"/>	<input type="radio"/>	<input type="radio"/>	<input type="radio"/>	<input type="radio"/>	<input type="radio"/>	<input type="radio"/>	<input type="radio"/>	<input type="radio"/>
Off	<input type="radio"/>	<input type="radio"/>	<input type="radio"/>	<input type="radio"/>	<input type="radio"/>	<input type="radio"/>	<input type="radio"/>	<input type="radio"/>	<input type="radio"/>	<input type="radio"/>
Sub Stream										
Auto	<input type="radio"/>	<input type="radio"/>	<input type="radio"/>	<input type="radio"/>	<input type="radio"/>	<input type="radio"/>	<input type="radio"/>	<input type="radio"/>	<input type="radio"/>	<input type="radio"/>
Manual	<input type="radio"/>	<input type="radio"/>	<input type="radio"/>	<input type="radio"/>	<input type="radio"/>	<input type="radio"/>	<input type="radio"/>	<input type="radio"/>	<input type="radio"/>	<input type="radio"/>
Off	<input type="radio"/>	<input checked="" type="radio"/>	<input checked="" type="radio"/>	<input checked="" type="radio"/>	<input checked="" type="radio"/>	<input checked="" type="radio"/>	<input checked="" type="radio"/>	<input checked="" type="radio"/>	<input checked="" type="radio"/>	<input checked="" type="radio"/>
Snapshot										
On	<input type="radio"/>	<input type="radio"/>	<input type="radio"/>	<input type="radio"/>	<input type="radio"/>	<input type="radio"/>	<input type="radio"/>	<input type="radio"/>	<input type="radio"/>	<input type="radio"/>
Off	<input type="radio"/>	<input checked="" type="radio"/>	<input checked="" type="radio"/>	<input checked="" type="radio"/>	<input checked="" type="radio"/>	<input checked="" type="radio"/>	<input checked="" type="radio"/>	<input checked="" type="radio"/>	<input checked="" type="radio"/>	<input checked="" type="radio"/>

Step 2 Configure the settings for the record control parameters.

Table 5-24 Record control parameters

Parameter	Description
Channel	Displays all the analog channels and the connected digital channels. You can select a single channel or select All .
Main Stream/Sub Stream	<ul style="list-style-type: none"> • Auto: Automatically record according to the record type and recording time as configured in the recording schedule. • Manual: Keep general recording for 24 hours for the selected channel. • Stop: Do not record.
Snapshot	Enable or disable the scheduled snapshot for the corresponding channels.

Step 3 Click **Apply**.

5.7.2 Configuring Recorded Video Storage Schedule

You need to configure the storage schedule for the recorded video so that the recorded video can be saved. For details, see "5.1.4.9 Configuring Recorded Video Storage Schedule".

5.8 Configuring Snapshot Settings

5.8.1 Configuring Snapshot Trigger

The snapshot is divided into scheduled snapshot, event triggered snapshot, and face detection triggered snapshot. When the both are enabled, the event triggered snapshot has the priority.

- If there is no alarm event, the system performs scheduled snapshot.
- If there is any alarm event, the system performs event triggered snapshot.

5.8.1.1 Configuring Scheduled Snapshot

Step 1 Right-click on the live view screen, the shortcut menu is displayed.

Step 2 On the shortcut menu, select **Manual Control > Record Control**.

Step 3 In the **Snapshot** area, enable the snapshot for the channels if needed.

Figure 5-103 Enable snapshot

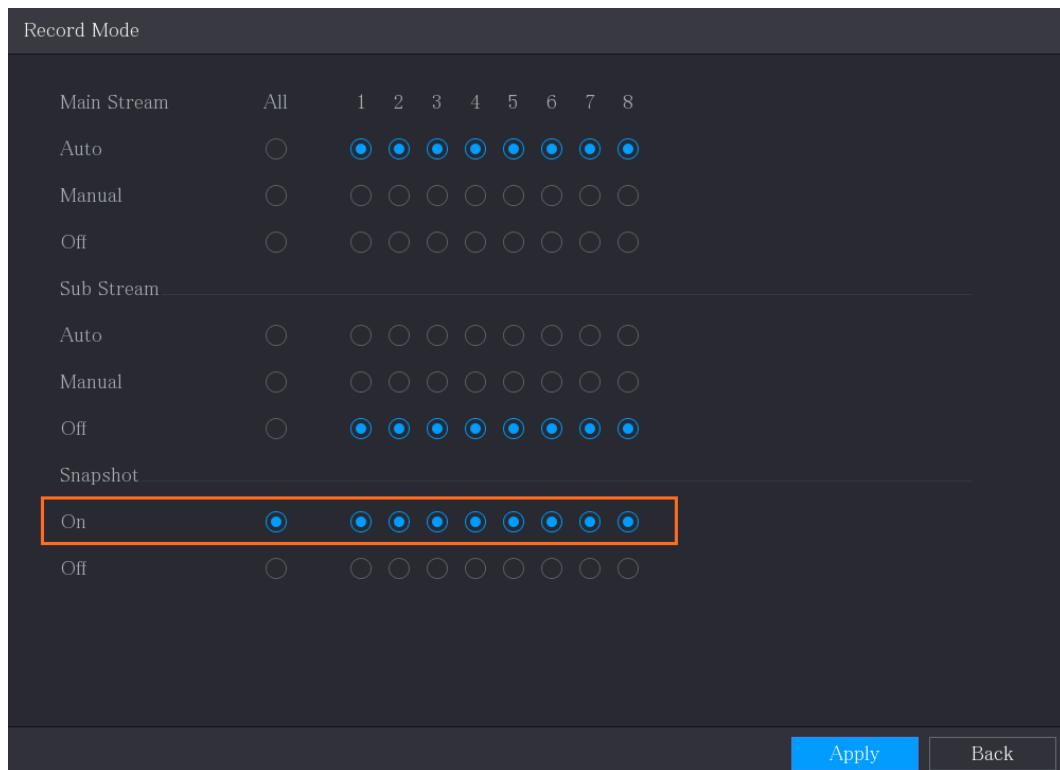

Step 4 Select **Main Menu > CAMERA > Encode > Snapshot**.

Step 5 In the **Type** list, select **Scheduled**, and then configure other parameters.

Figure 5-104 Type list

Audio/Video	Snapshot	Encode Enhanc...
Manual Snapshot	1	/Time
Channel	1	
Type	Scheduled	
Size	352x288(CIF)	
Quality	4	
Interval	1 sec.	

Step 6 Click **Apply** to save the settings.

- If you have configured the snapshot schedule, the configuration has been completed.
- If you have not configured the snapshot schedule, see "5.1.4.10 Configuring Snapshot Storage Schedule".

5.8.1.2 Configuring Event Triggered Snapshot

Step 1 Select **Main Menu > CAMERA > Encode > Snapshot**.

Step 2 In the **Type** list, select **Event**, and then configure other parameters.

Figure 5-105 Event

Audio/Video	Snapshot	Encode Enhanc...
Manual Snapshot	1	/Time
Channel	1	
Type	Event	
Size	352x288(CIF)	
Quality	4	
Interval	1 sec.	

Step 3 Select **Main Menu > ALARM > Video Detection**, and select the event type to configure, for example, select the **Motion Detection** tab.

Figure 5-106 Motion detection

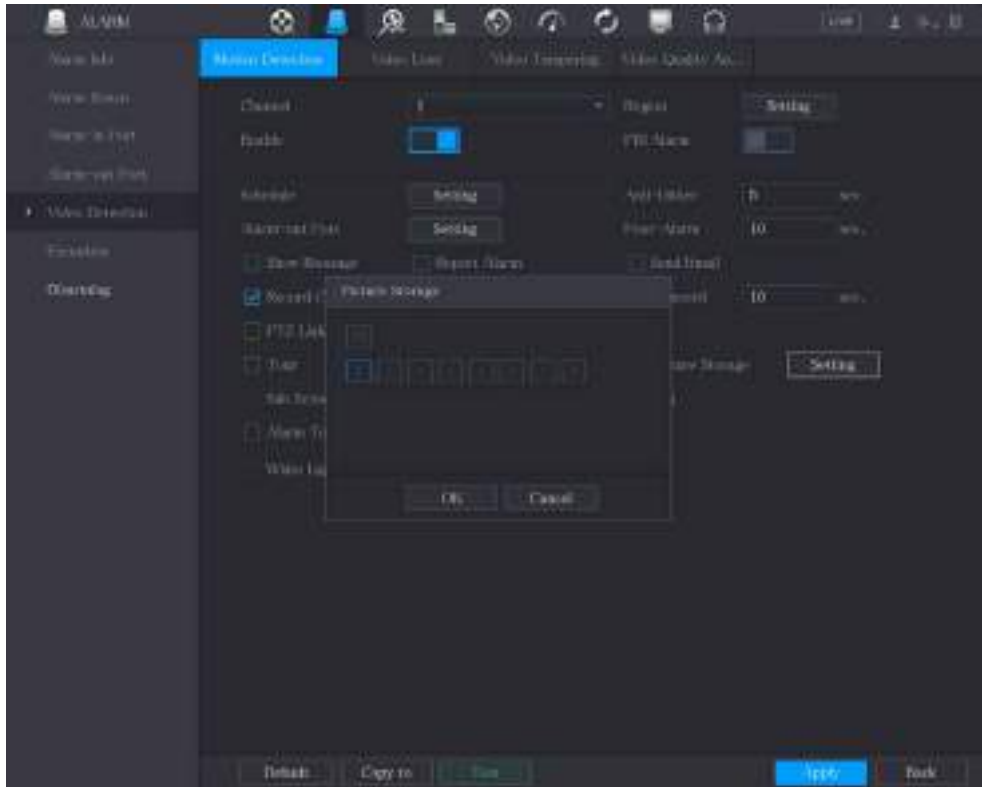

Step 4 Click **Setting** next to **Picture Storage** checkbox and select the corresponding channel.

Step 5 Click **Apply**.

5.8.2 Configuring Snapshot Storage Schedule

You need to configure the storage schedule for the snapshot so that the snapshot can be saved. For details, see "5.1.4.10 Configuring Snapshot Storage Schedule".

5.8.3 Backing up Snapshots to FTP

Step 1 Select **Main Menu > STORAGE > FTP**.

Figure 5-107 FTP

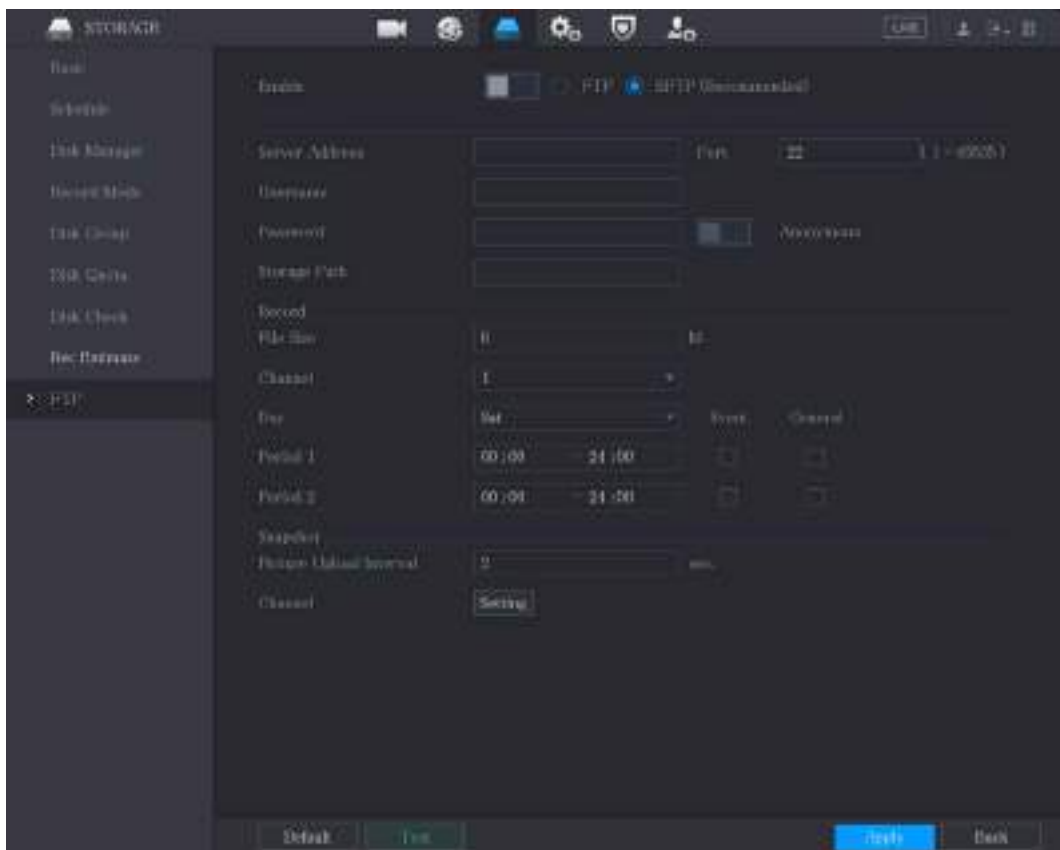

Step 2 Enable the FTP function and configure the parameters. For details, see "5.18.9 Configuring FTP Storage Settings".

The snapshots will be uploaded to FTP for backup.

5.9 Playing Back Video

5.9.1 Enabling Record Control



- Manual recording operation requires the user have the permission to access **STORAGE** settings.
- Check to ensure the HDD installed in the Device has been formatted properly.

To enter the record control page, do the following:

Step 1 Right-click on the live view screen, the shortcut menu is displayed. On the shortcut menu, select **Manual Control > Record Mode**.

Figure 5-108 Record mode

Step 2 Configure the settings for the record control parameters.

Table 5-25 Record control parameters

Parameter	Description
Channel	Displays all the analog channels and the connected digital channels. You can select a single channel or select All .
Main Stream/Sub Stream	<ul style="list-style-type: none"> ● Auto: Automatically record according to the record type and recording time as configured in the recording schedule. ● Manual: Keep general recording for 24 hours for the selected channel. ● Stop: Do not record.
Snapshot	Enable or disable the scheduled snapshot for the corresponding channels.

5.9.2 Instant Playback

You can use the instant playback function to play back the previous 5 seconds to 60 minutes of the recorded video in any channel. For details about instant playback function, see "5.2.2.1 Instant Playback".

5.9.3 Video Playback

You can search for and play back the recorded video saved on the Device.

Select **Main Menu > Search**.

Figure 5-109 Video search

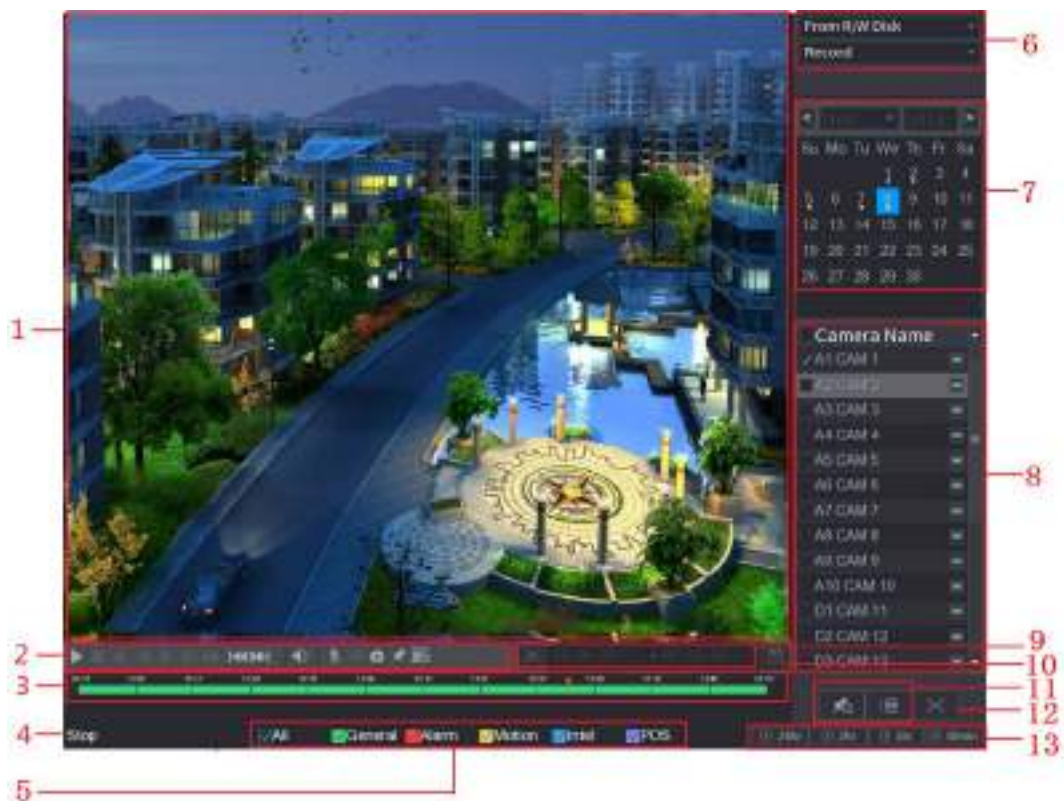







Figure 5-110 Video search description

No.	Function	Description
1	Display Window	Display the searched recorded video or picture. Supports simultaneously playing in single-channel, 4-channel, 9-channel, and 16-channel. When playing back in a single channel, click and hold to select the area that you want to enlarge. The area is enlarged after the left mouse button is released. To exit the enlarged status, right-click on the image.
2	Playback Controls Bar	Playback control buttons. For details about the control buttons, see "5.9.3.1 Introducing Playback Controls".

No.	Function	Description
3	Time Bar	<p>Display the type and time period of the current recorded video.</p> <ul style="list-style-type: none"> ● In the 4-channel layout, there are four time bars are displayed; in the other view layouts, only one time bar is displayed. ● Click on the colored area to start playback from a certain time. ● In the situation when you are configuring the settings, rotate the wheel button on the time bar, the time bar is zooming in from 0. In the situation when playback is ongoing, rotate the wheel button on the time bar, the time bar is zooming from the time point where the playback is located. ● Time bar colors: Green indicates general type; Red indicates external alarm; Yellow indicates motion detection; Blue indicates intelligent events; Purple indicates POS events. ● For some models, when you are clicking on the blank area in the time bar, the system automatically jumps to the next time point where there is a recorded video located. ● Click and hold the time bar, and the mouse pointer shall change to a hand icon, and then you can drag to view the playback of the target time. ● You can drag the vertical orange line on the time bar to rapidly view the playback in iframe format. ● When playing back video in one channel mode, you can move mouse pointer to time bar to display thumbnail pictures for the video of target time. ● When playing back video, you can select other channels as needed. The time bar of newly added channels will be added up to the time bar of earlier base channels. The type and time period of newly added channels are the same with early base channels.
4	Play Status	Includes two playback status: Play and Stop .
5	Record type	Select the checkbox to define the recording type to search for.
6	Search type	Select the content to play back: Record , Picture , Subperiod . For details about the selecting search type, see "5.9.3.2 Selecting Search Type".
7	Calendar	<p>Click the date that you want to search, the time bar displays the corresponding record.</p> <p>The dates with record or snapshot have a small solid circle under the date.</p>

No.	Function	Description
8	View Layout and Channel Selection	<p>In the Camera Name list, select the channel(s) that you want to play back.</p> <ul style="list-style-type: none"> The window split is decided by how you select the channel(s). For example, if you select one channel, the playback is displayed in the single-channel view; if you select two to four channels, the playback is displayed in the four-channel view. The maximum is eight channels. Click  to switch the streams.  indicates main stream, and  indicates sub stream.
9	Video Splice	Splice a section of recorded video and save it. For details about splicing a recorded video, see "5.9.3.3 Clipping Recorded Video".
10	Backup	Back up the recorded video files. For details, see "5.9.3.4 Backing up Recorded Video."
11	List Display	<p>This area includes Tag List and File List.</p> <ul style="list-style-type: none"> : Click the Tag List button, the marked recorded video list is displayed. Double-click the file to start playing. : Click the File List button, the searched recorded video list is displayed. You can lock the files. For details, see "5.9.9 Using the File List".
12	Full Screen	Click  to display in full screen. In the full screen mode, point to the bottom of the screen, the time bar is displayed. Right-click on the screen to exit full screen mode.
13	Time Bar Unit	You can select 24 hr, 2 hr, 1 hr, or 30 min as the unit of time bar. The time bar display changes with the setting.

5.9.3.1 Introducing Playback Controls Bar

You can perform the operations such as control the speed of playback, add mark, and take snapshots through the playback controls bar.

Figure 5-111 Playback control bar



The play backward function and playback speed are dependent on the product version. The actual product shall govern. You can also contact the technical support to consult the hardware version information.

Table 5-26 Playback control bar description

Icon	Function
	Play/Pause. During playing back, you can switch between play and pause.
	Stop. During playing back, you can click the Stop button to stop playback.
	Play backward. <ul style="list-style-type: none"> During playing back, click the Play Backward button to backward play the recorded video, the button switches to ; click to stop playing backward. During playing back, click to start playing forward.
	Previous and next frame. <ul style="list-style-type: none"> When the playback is paused, click or click to play single-frame recorded video. When playing back single-frame recorded video, click to start playing forward.
	Slow playback. <ul style="list-style-type: none"> During playing back, click to set the speed of slow playback as SlowX1/2, SlowX1/4, SlowX1/8, or SlowX1/16. During fast playback, click to slow down the speed of fast playback.
	Fast playback. <ul style="list-style-type: none"> During playing back, click to set the speed of fast playback as FastX2, FastX4, FastX8, or FastX16. During slow playback, click to speed up slow playback.
	Previous day and next Day. Click or click to play the previous day or next day of the current recorded video.
	Adjust volume of playback.
	Enable smart search function. For details about using the smart search, see "5.9.4 Smart Search".
	Add filter criteria of smart search. You can select Human , Vehicle , or uncheck. For details about using the smart search, see "5.9.4 Smart Search".

Icon	Function
	In the full screen mode, click to take a snapshot and save into the USB storage device or mobile HDD.
	Add Mark for the recorded view. For details about adding mark, see "5.9.6 Marking and Playing Back Video".
	Show or hide POS information. During single-channel playback, click to show or hide POS information on the screen.
	During playback, click this icon to display or hide AI rulers. For more details, see "5.9.5 Showing AI Rule during Playback".
	Show playback video in full screen.

5.9.3.2 Selecting Search Type

You can search the recorded videos, splice, or snapshots from HDD or external storage device.

- **From R/W Disk:** Recorded videos or snapshots playback from HDD of the Device.

Figure 5-112 From R/W disk

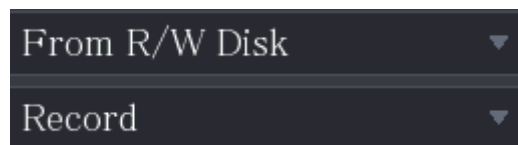

- **From I/O Device:** Recorded videos playback from external storage device.
Click **Browse**, select the save path of recorded video file that you want to play. Double-click the video file or click to start playing.

Figure 5-113 From I/O device

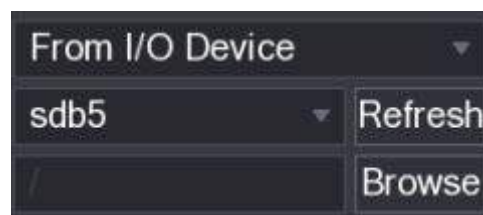

5.9.3.3 Clipping Recorded Video

During playback, clip sections of recorded video and save to the USB storage device.

Figure 5-114 Clip



Step 1 Select a recorded video that you want to play.

- Click  to start playing from the beginning.
- Double-click anywhere in the time bar colored area to start playback.

Step 2 Click on the time bar to select the start time, and then click  to start clipping.

Step 3 Click on the time bar to select the end time, and then click  to stop clipping.

Step 4 Click .



- You can clip the video of a single-channel or multiple channels.
- Maximum 1024 files can be backed up at one time.
- The files that are selected in the **File List** cannot be clipped.

5.9.3.4 Backing up Recorded Video

You can back up the recorded video file or splice video file into the USB storage device.

Step 1 Select the recorded video file that you want to back up. You can select the following two types of files:

- Recorded video file: Click , the **File List** area is displayed. Select the file(s) that you want to back up.
- Splice video file. For details about splicing video file, see "5.9.3.3 Clipping Recorded Video".

Step 2 Click .

Figure 5-115 Backup

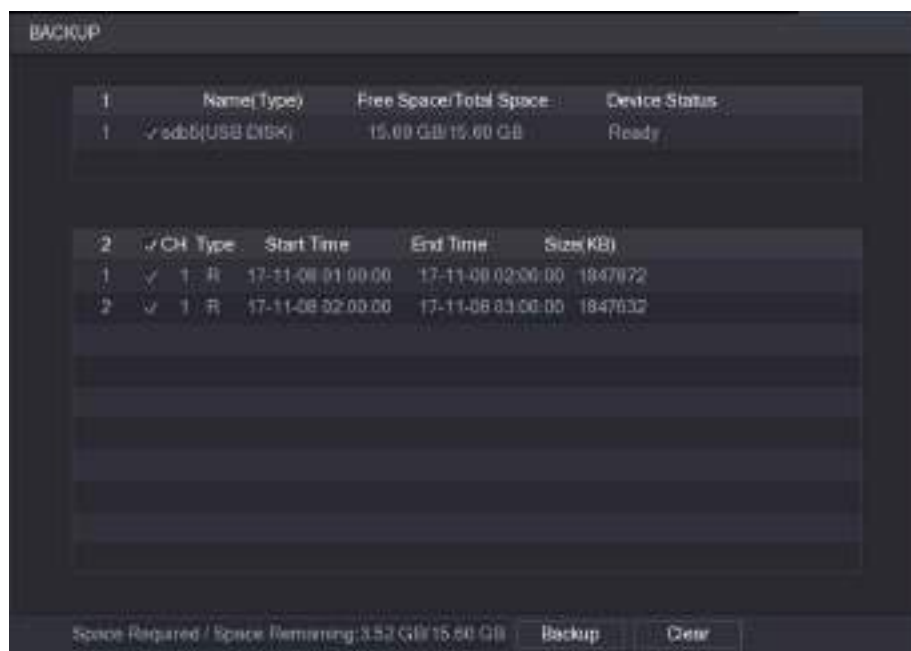

Step 3 Click **Backup**.



If you do not want to back the file, clear the checkbox.

5.9.4 Smart Search

During playback, you can analyze a certain area to find if there was any motion detection event occurred. The system will display the images with motion events of the recorded video.



Not all models support this function.

To use the Smart Search function, you need to enable the motion detection for the channel by selecting **Main Menu > ALARM > Video Detection > Motion Detection**.

To use the Smart Search function, do the following:

Step 1 Select **Main Menu > SEARCH**, the video search page is displayed.

Step 2 In the **Camera Name** list, select the channel(s) that you want to play.

Step 3 Click  or double-click anywhere in the time bar colored area to start playback.

Step 4 Click .

The grid is displayed on the screen.



- Only single-channel supports smart search.
- If multi-channels are selected, double-click on the channel window to display this channel only on the screen, and then you can start using smart search function.

Step 5 Drag the pointer to select the searching area.



The grid area supports 22 × 18 (PAL) and 22 × 15 (NTSC).

Step 6 Click  to add filter criteria. You can check **Human** box, **Vehicle** box, or uncheck.

- Human: Display the motion alarm of human during selected time and searching area.
- Vehicle: Display the motion alarm of vehicle during selected time and searching area.
- Unchecking: Display the general motion alarm which includes both human and vehicle, during selected time and searching area.

Step 7 Click .

The screen starts playing back the motional splices of recorded video for the selected searching area.

Step 8 Click  to exit the smart searching while playback.

5.9.5 Showing AI Rule during Playback

To use the AI rule showing function, do the following:

Step 1 Select **Main Menu > SEARCH**.

Step 2 In the **Camera Name** list, select the channel(s) that you want to play.

Step 3 Click  or double-click anywhere in the time bar colored area to start playback.

You can see the AI rule during playback. This function is enabled by default.

Figure 5-116 Playback

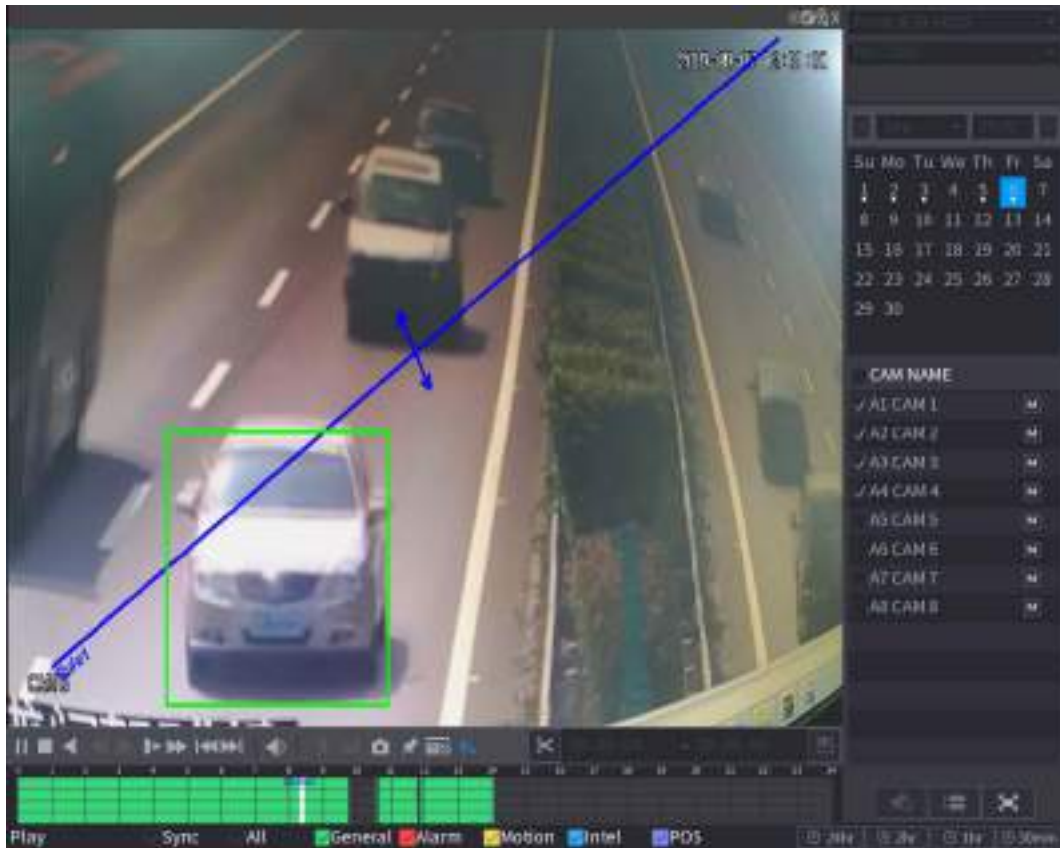

Click  to hide AI rule.

5.9.6 Marking and Playing Back Video

You can mark the recording for somewhere important. Then you can easily find the marked recording by searching time and mark name.

Marking a Video

Step 1 Select **Main Menu > SEARCH**.

Step 2 In the playback mode, click .

Figure 5-117 Add tag

Step 3 In the **Tag Name** box, enter a name.

Step 4 Click **OK**.

This marked video file displays in the **Tag List**.

Playing Back Marked Video



This function is supported on single-channel playback.

Step 1 In the **Camera Name** list, select one channel.

Step 2 Click .

Figure 5-118 Mark list

Step 3 Double-click the file that you want to play back.

To search the marked video by time, in the **SEARCH** box on the top of the page, enter the time, and then click .

Playing Back Time before the Tag

You can configure to play N seconds of the tagged video before the tagged time.

Step 1 In the **Tag Name** box, enter the name of a tagged video.

Step 2 In the **Interval Before Tag** box, enter N seconds.

Step 3 Click

The playback starts from N seconds before the tagged time.



If there is N seconds exist before the marked time, the playback starts from N seconds before the tagged time. If there is not, it plays back as much as there is.

Managing Tagged Video

On the **Tag List** page, click

Figure 5-119 Tag management

ID	CH	Tag Time	Tag Name
1	8	2020-01-04 11:29:14	uuuu
2	8	2020-01-04 11:43:55	errt

- Be default, it manages all the tagged videos of the selected channel.
- To search the tagged video, select channel number from the **Channel** list, enter time in **Start Time** box and **End Time** box, and then click **Search**.
- All the tagged videos display in time order.
- To modify the name of tagged video, double-click a tagged video.
- To delete the marked video, select the tagged video, and then click **Delete**.



After opening the **Tag Management** page, the playback will pause until exiting this page. If the marked video that was in playing back is deleted, the playback will start from the first tagged video in the **Tag List**.

5.9.7 Playing Back Snapshots

You can search and play back the snapshots.

Step 1 Select **Main Menu > SEARCH**.

Step 2 In the **Search Type** list, select **Picture**.

Step 3 In the **Channel** list, select a channel number.

Step 4 In the **Calendar** area, select a date.

Step 5 Click .

The system starts playing snapshots according to the configured intervals.

5.9.8 Playing Back Splices

You can clip the recorded video files into splices and then play back at the same time to save your time.



Not all models support this function.

Step 1 Select **Main Menu > SEARCH**.

Step 2 In the **Search Type** list, select **Subperiod**; In the Split Mode list, select **4, 9, or 16**.

Figure 5-120 Subperiod

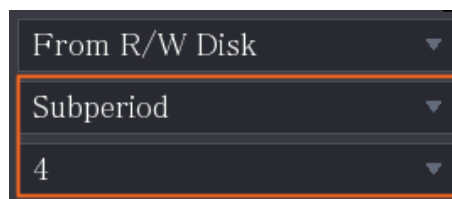

Step 3 In the **Calendar** area, select a date.

Step 4 In the **Camera Name** list, select a channel.



Only single-channel supports this function.

Step 5 Start playing back splices.

- Click , the playback starts from the beginning.
- Double-click anywhere on the time bar, the playback starts from where you click.

Figure 5-121 Time bar



Every recorded video file must be at least five minutes. If a recorded video file is less than 20 minutes but still choose to split into four windows, the system will automatically adjust the windows quantity to ensure every splice is more than five minutes, and in this case it is possible that there are no images are displaying in some windows.

5.9.9 Using the File List

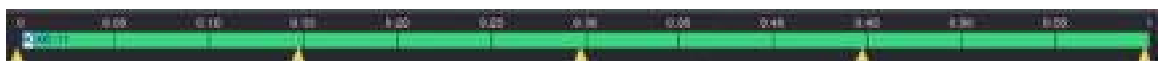
You can view all the recorded videos within a certain period from any channel in the **File List**.

Step 1 Select **Main Menu > VIDEO**.

Step 2 Select a channel(s).

Step 3 Click .

Figure 5-122 File list

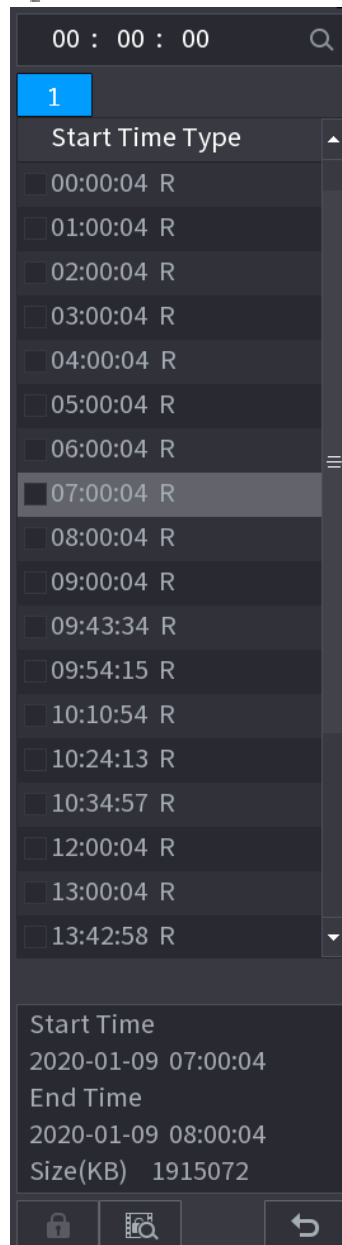

Step 4 Start playback.

- Click , the playback starts from the first file by default.
- Click any file, the system plays back this file.



- In the time box on the top of the file list page, you can enter the specific time to search the file that you want to view.

- In the File List area, there are 128 files can be displayed.
- File type: **R** indicates general recorded video; **A** indicates recorded video with external alarms; **M** indicates recorded video with motion detection events; **I** indicates recorded video with intelligent vents.
- Click  to return to the page with calendar and CAM NAME list.

Locking and Unlocking the Recorded Video



- To lock the recorded video, on the **File List** page, select the checkbox of the recorded video, and then click . The locked video will not be covered.
- To view the locked information, click  .
The recorded video that is under writing or overwriting cannot be locked.
- To unlock the recorded video, in the **File Lock** page, select the video, and then click **Unlock**.

Figure 5-123 File lock



5.10 Alarm Events Settings

5.10.1 Alarm Information

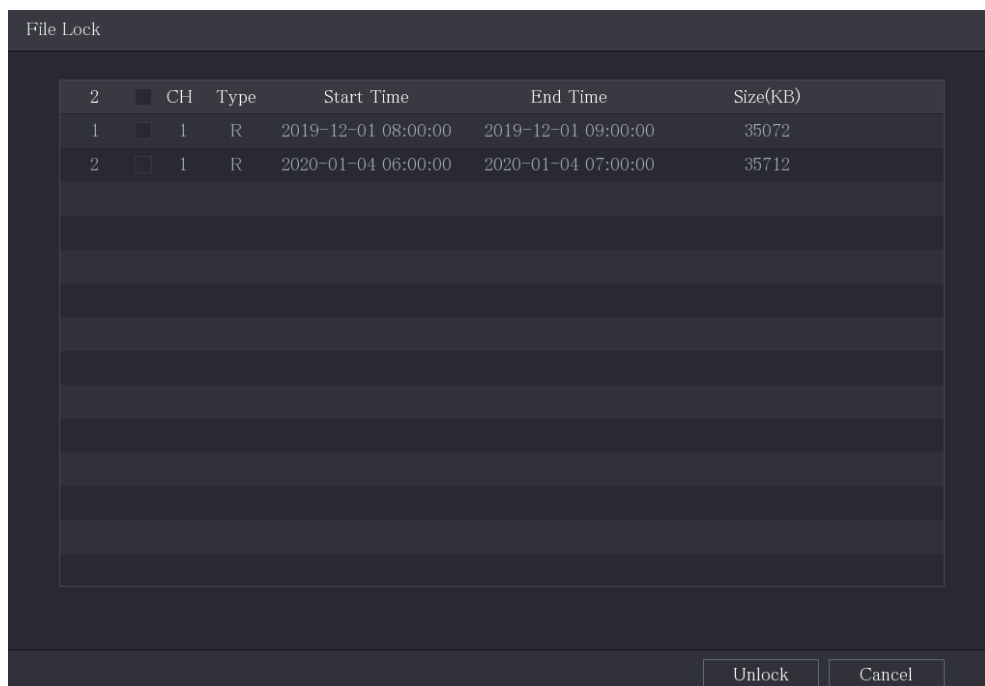
You can search, view and back up the alarm information.

Step 1 Select **Main Menu > ALARM > Alarm Info**.

Figure 5-124 Alarm info

The screenshot shows the 'Alarm info' interface. At the top, there are search filters: 'Type' set to 'All', 'Start Time' set to '2020-01-04 00:00:00', and 'End Time' set to '2020-01-05 00:00:00'. A 'Search' button is located to the right of the end time field. Below the filters is a table with 13 rows of alarm events. Each row contains an ID, a timestamp, a description, and a search icon. The table is currently displaying 13 events, with the last one selected. At the bottom of the interface, there are navigation controls including a page indicator '1/1', a 'Go to' field with '1', and buttons for 'Backup' and 'Details'.

ID	Time	Type	Search
1	2020-01-04 00:41:27	<Tampering : 8>	▶
2	2020-01-04 00:41:29	<Tampering : 8>	▶
3	2020-01-04 09:05:33	<Tampering : 8>	▶
4	2020-01-04 09:05:34	<Tampering : 8>	▶
5	2020-01-04 12:33:15	<Tampering : 8>	▶
6	2020-01-04 12:33:16	<Tampering : 8>	▶
7	2020-01-04 13:31:34	<Network Disconnection Event : 1>	▶
8	2020-01-04 13:31:39	<CAM Offline Alarm : 8>	▶
9	2020-01-04 14:04:04	<Network Disconnection Event : 1>	▶
10	2020-01-04 14:04:29	<CAM Offline Alarm : 8>	▶
11	2020-01-04 15:12:09	<CAM Offline Alarm : 8>	▶
12	2020-01-04 16:23:43	<Network Disconnection Event : 1>	▶
13	2020-01-04 16:23:53	<Network Disconnection Event : 1>	▶

Step 2 In the **Type** list, select the event type; In the **Start Time** box and **End Time** box, enter the specific time.

Step 3 Click **Search**.

The search results are displayed.

Step 4 Click **Backup** to back up the search results into the external storage device.



- Click to play the recorded video of alarm event.
- Select an event and click **Details** to view the detailed information of the event.

5.10.2 Alarm Input Settings

Connect the alarm input and output ports by referring to "4.3 Connecting to Alarm Input and Output". You can configure the alarm settings for each channel individually or apply the settings to all channels and then save the settings.

5.10.2.1 Configuring Local Alarms

You can connect the alarm device to the alarm input port of the Device. When the alarm is activated on the alarm device, the alarm information will be uploaded to the Device, and then the Device outputs the local alarms in the way that you configure in this section.

Step 1 Select **Main Menu > ALARM > Alarm-in Port > Local**.



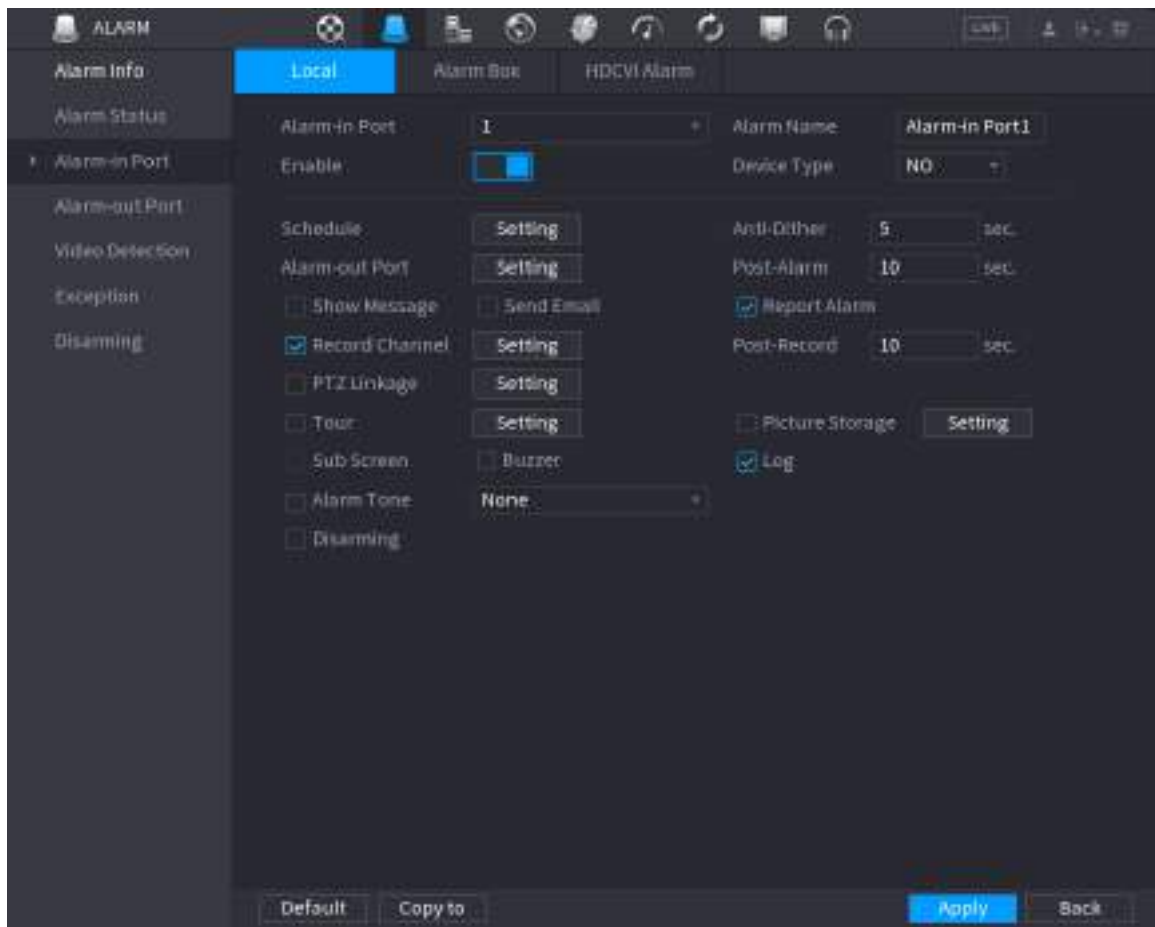

Figure 5-125 Local page



Step 2 Configure the settings for the local alarms.

Table 5-27 Local alarm settings

Parameter	Description
Alarm-in Port	Select the channel number.
Alarm Name	Enter the customized alarm name.
Enable	Enable or disable the local alarm function.
Device Type	In the Device Type list, select NO or select NC as the voltage output type.
Schedule	Click Setting to display setting interface. Define a period during which the motion detection is active. For details, see "Setting Motion Detection Period" section in "5.10.4.1 Configuring Motion Detection Settings".
Anti-Dither	Configure the time period from end of event detection to the stop of alarm.

Parameter	Description
Alarm-out Port	<p>Click Setting to display setting page.</p> <ul style="list-style-type: none"> Local Alarm: Enable alarm activation through the alarm devices connected to the selected output port. Extension Alarm: Enable alarm activation through the connected alarm box. Wireless Siren: Enable alarm activation through devices connected by USB gateway or camera gateway.
Post-Alarm	<p>Set a length of time for the Device to delay turning off alarm after the external alarm is cancelled. The value ranges from 0 seconds to 300 seconds, and the default value is 10 seconds.</p>
Show Message	<p>Select the Show Message checkbox to enable a pop-up message in your local host PC.</p>
Report Alarm	<p>Select the Report Alarm checkbox to enable the system to upload the alarm signal to the network (including alarm center) when an alarm event occurs.</p>
Send Email	<p>Select the Send Email checkbox to enable the system to send an email notification when an alarm event occurs.</p>  <p>To use this function, make sure the email function is enabled in Main Menu > NETWORK > Email.</p>
Record Channel	<p>Select the channel(s) that you want to record. The selected channel(s) starts recording after an alarm event occurs.</p>  <p>The recording for local alarm recording and auto recording must be enabled. For details, see "5.1.4.9 Configuring Recorded Video Storage Schedule" and "5.9.1 Enabling Record Control".</p>
PTZ Linkage	<p>Click Setting to display the PTZ page.</p> <p>Enable PTZ linkage actions, such as selecting the preset that you want to be called when an alarm event occurs.</p>
Post Record	<p>Set a length of time for the Device to delay turning off recording after the alarm is cancelled. The value ranges from 10 seconds to 300 seconds, and the default value is 10 seconds.</p>
Tour	<p>Select the Tour checkbox to enable a tour of the selected channels.</p>
Picture Storage	<p>Select the Snapshot checkbox to take a snapshot of the selected channel.</p>  <p>To use this function, select Main Menu > CAMERA > Encode > Snapshot, in the Type list, select Event.</p>
Sub Screen	<p>Select the checkbox to enable the function. When an alarm event occurs, the extra screen outputs the settings configured in Main Menu > DISPLAY > Tour Setting > Sub Screen.</p>  <ul style="list-style-type: none"> Not all models support this function. To use this function, extra screen shall be enabled.

Parameter	Description
Video Matrix	Select the checkbox to enable the function. When an alarm event occurs, the video output port outputs the settings configured in Main Menu > DISPLAY > Tour Setting .  Not all models support this function.
Buzzer	Select the checkbox to activate a buzzer noise at the Device.
Log	Select the checkbox to enable the Device to record a local alarm log.
Disarming	After enabling this function, you can connect a switch to the alarm input port for disarming control.

Step 3 Click **Apply** to complete the settings.



- Click **Default** to restore the default setting.
- Click **Copy to**, in the **Copy to** dialog box, select the additional channel(s) that you want to copy the local alarm settings to, and then click **Apply**.

5.10.2.2 Configuring Alarms from Alarm Box

You can connect the alarm box to the RS-485 port of the Device. When the alarm is detected by the alarm box, the alarm information will be uploaded to the Device, and then the Device outputs the alarms in the way that you configure in this section.

Step 1 Select **Main Menu > ALARM > Alarm-in Port > Alarm Box**.

Figure 5-126 Alarm box

Local	Alarm Box	CAM Ext	CAM Offline	HDCVI Alarm
Alarm Box	<input type="text"/>		Status	
Alarm-in Port	<input type="text"/>		Alarm Name	<input type="text" value="Alarm-in Port 1"/>
Enable	<input type="checkbox"/>		Device Type	<input type="text" value="NO"/>
Schedule	<input type="text" value="Setting"/>		Anti-Dither	<input type="text" value="0"/> sec.
Alarm-out Port	<input type="text" value="Setting"/>		Post-Alarm	<input type="text" value="10"/> sec.
<input type="checkbox"/> Show Message	<input checked="" type="checkbox"/> Report Alarm		<input type="checkbox"/> Send Email	
<input checked="" type="checkbox"/> Record Channel	<input type="text" value="Setting"/>		Post-Record	<input type="text" value="10"/> sec.
<input type="checkbox"/> PTZ Linkage	<input type="text" value="Setting"/>		<input type="checkbox"/> Picture Storage	<input type="text" value="Setting"/>
<input type="checkbox"/> Tour	<input type="text" value="Setting"/>		<input checked="" type="checkbox"/> Log	
<input type="checkbox"/> Sub Screen	<input type="checkbox"/> Buzzer			
<input type="checkbox"/> Alarm Tone	<input type="text" value="None"/>			
<input type="text" value="Default"/>		<input type="text" value="Apply"/>		<input type="text" value="Back"/>

- Step 2** In the **Alarm Box** list, select the alarm box number corresponding to the address number configured by the DIP switch on the Alarm Box.
- Step 3** In the **Alarm-in Port** list, select the alarm input port on the Alarm Box.
- Step 4** Configure the settings for other parameters of the Alarm Box.
- Step 5** Click **Apply** to complete the settings.



Click **Default** to restore the default setting.

5.10.2.3 Configuring Alarms from External IP Cameras

- Step 1** Select **Main Menu > ALARM > Alarm-in Port > CAM Ext.**

Figure 5-127 CAM ext

Local	Alarm Box	CAM Ext	CAM Offline	HDCVI Alarm
Channel	8	Alarm Name	Alarm-in Port8	
Enable	<input checked="" type="checkbox"/>	Device Type	NO	
Schedule	Setting	Anti-Dither	5	sec.
Alarm-out Port	Setting	Post-Alarm	10	sec.
<input type="checkbox"/> Show Message	<input checked="" type="checkbox"/> Report Alarm	<input type="checkbox"/> Send Email		
<input type="checkbox"/> Record Channel	Setting	Post-Record	10	sec.
<input type="checkbox"/> PTZ Linkage	Setting	<input type="checkbox"/> Picture Storage	Setting	
<input type="checkbox"/> Tour	Setting	<input type="checkbox"/> Buzzer	<input checked="" type="checkbox"/> Log	
<input type="checkbox"/> Sub Screen	<input type="checkbox"/> Buzzer	<input checked="" type="checkbox"/> Log		
<input type="checkbox"/> Alarm Tone	None			
Default		Copy to	Refresh	Apply
				Back

- Step 2** Configure the alarm input settings from the external IPC.

- Step 3** Click **Apply** to complete the settings.



- Click **Default** to restore the default setting.
- Click **Copy to** to copy the settings to other channels.
- Click **Refresh** to refresh configured settings.

5.10.2.4 Configuring Alarms for IP Camera Offline

You can configure the alarm settings for the situation when the IP camera is offline.

- Step 1** Select **Main Menu > ALARM > Alarm-in Port > CAM Offline.**

Figure 5-128 CAM offline

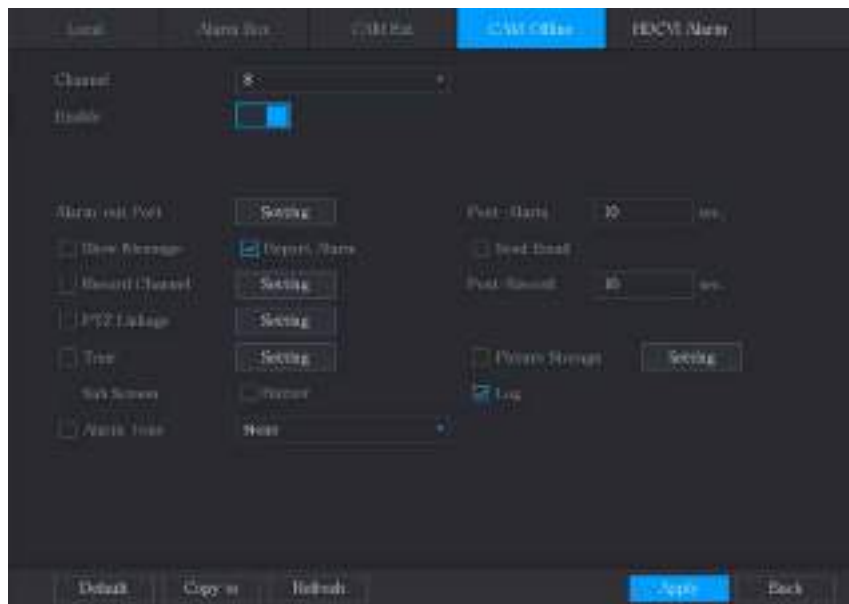

Step 2 Configure the alarm input settings from the offline IPC.

Step 3 Click **Apply** to complete the settings.



- Click **Default** to restore the default setting.
- Click **Copy to** to copy the settings to other channels.

5.10.2.5 Configuring Alarms from HDCVI Devices

Step 1 Select **Main Menu > ALARM > Alarm-in Port > HDCVI Alarm**.

Figure 5-129 HDCVI alarm

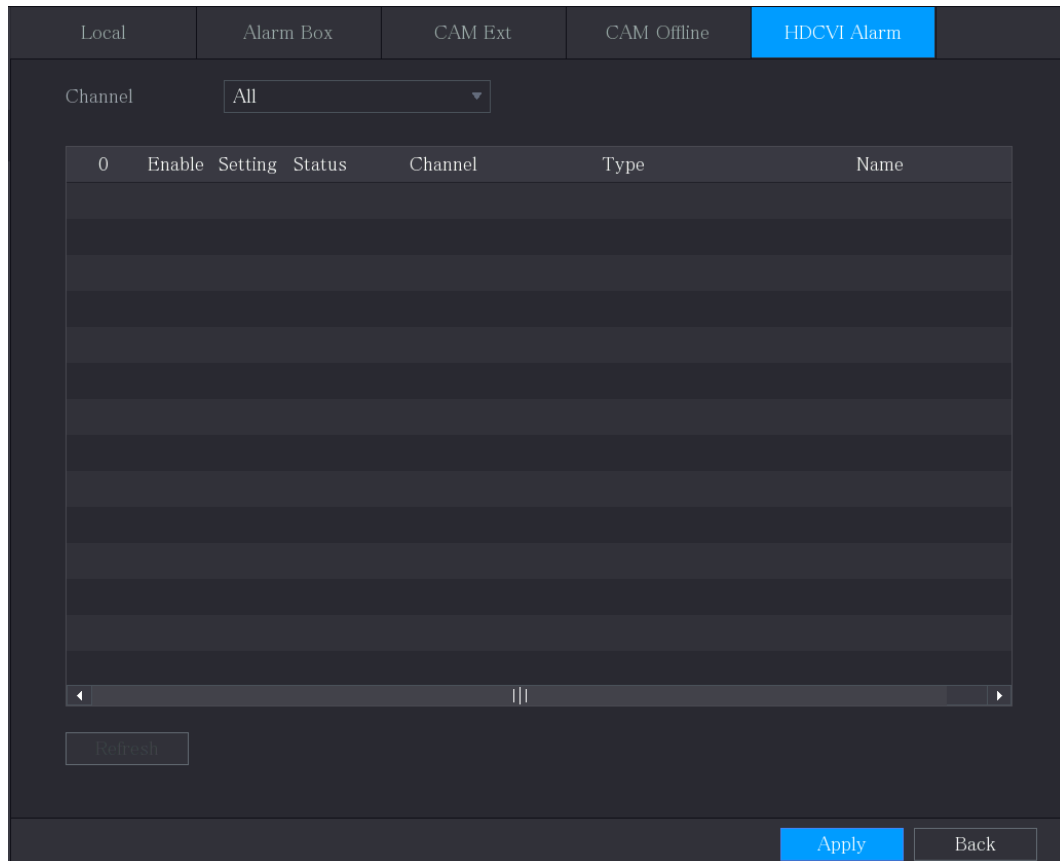

Step 2 In the **Channel** list, select a channel or **All**.

Step 3 Click .

Step 4 Configure the settings for other parameters of the Alarm Box.

Step 5 Click **OK** to save the settings.

Step 6 Click **Apply** to complete the settings.

5.10.3 Alarm Output Settings

5.10.3.1 Configuring Alarm Output

When the Device activates alarms, the connected alarm device generates alarms in the way that you can configure in this section. You can connect to the output port of the Device or connect wirelessly.

- **Auto:** When an alarm event is triggered on the Device, the connected alarm device generates alarms.
- **Manual:** The alarm device is forced to keep generating alarms.
- **Stop:** The alarm output function is not enabled.

Step 1 Select **Main Menu > ALARM > Alarm-out Port > Alarm Mode**.

Figure 5-130 Alarm mode

Step 2 Configure the settings for the alarm output.

Table 5-28 Alarm output settings

Parameter		Description
Local Alarm	Alarm Type	Select alarm type for each alarm output port.
	Status	Indicates the status of each alarm output port.
Extension Alarm	Alarm Box	Select the alarm box number corresponding to the address number configured by the DIP switch on the Alarm Box.
	Alarm Type	Select the alarm type for each alarm output ports.
	Status	Indicates the status of each alarm output port.
Alarm Reset		Click OK to clear all alarm output status.

Step 3 Click **Apply** to save the settings.

5.10.3.2 Configuring Warning Light

When the motion detection alarm is activated, the system links the camera to generate warning light alarm.



To use this function, connect at least one warning light camera to your Device.

Step 1 Select **Main Menu > ALARM > Alarm-out Port > Warning Light**.

Figure 5-131 Warning light

Step 2 Configure the settings for the warning light parameters.

Table 5-29 Warning light parameters

Parameter	Description
Channel	In the Channel list, select a channel that is connected to a warning light camera.
Delay	Set a length of time for the Device to delay turning off alarm after the alarm is cancelled. The value ranges from 5 seconds to 30 seconds, and the default value is 5 seconds.
Mode	Set the alarm mode of warning light to be Always on or Flicker .
Flicker Frequency	When setting the alarm mode of warning light to be Flash , you can select the flash frequency from Low , Middle , and High .

Step 3 Click **Apply** to complete the settings.

5.10.3.3 Configuring Siren

When the motion detection alarm is activated, the system links the camera to generate sound alarm.



To use this function, connect at least one camera that supports audio function.

Step 1 Select **Main Menu > ALARM > Alarm-out Port > Siren**.

Figure 5-132 Siren

Step 2 Configure the settings for the siren parameters.

Table 5-30 Siren parameters

Parameter	Description
Channel	In the Channel list, select a channel that is connected to a camera that supports audio function.
Play	Click Play to manually trigger the IP camera to play audio file.
Delay	Set a length of time for the Device to delay turning off alarm after the alarm is cancelled. The value ranges from 5 seconds to 30 seconds, and the default value is 5 seconds.
Audio Clip	Select the audio clip for the siren sound. The default setting is Clip 1 .
Volume	Select the volume for the audio clip. You can select the flash frequency from Low, Middle, and High .
Update Audio Clip	Import the upgrade audio file (.bin or .wav) to upgrade the alarm audio file of the camera.

Step 3 Click **Apply** to complete the settings.

Related Operations

You can update the audio files of the camera on the local interface.

1. Prepare a USB device or other external storage device and plug it into the Device.
2. Click **Browse**.
3. Select the upgrade audio file (.bin or .wav).
4. Click **OK** to return to the Siren page.

5. Click **Upgrade** to upgrade the alarm audio file of the camera.

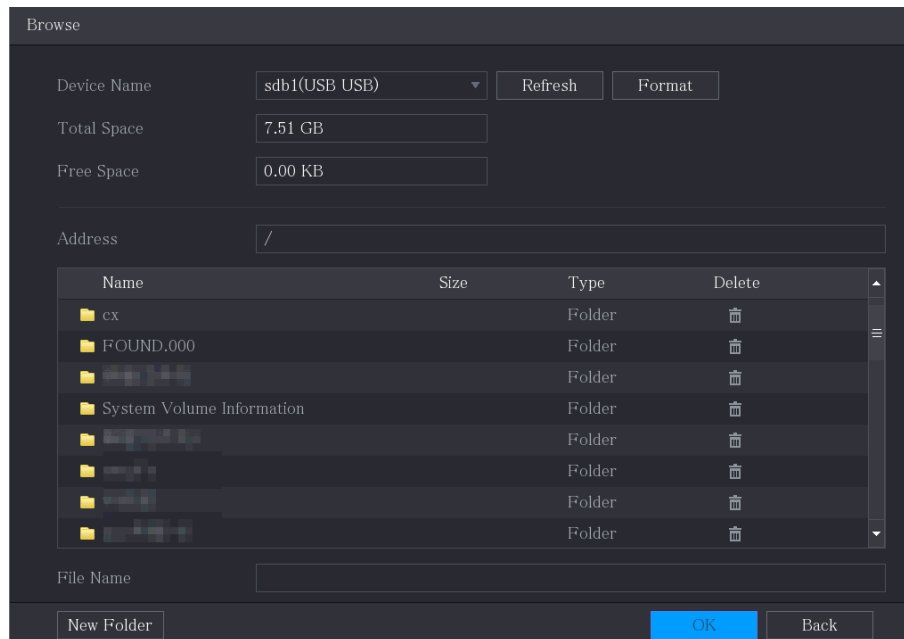
Figure 5-133 Browse

5.10.4 Video Detection

Video detection adopts computer vision and image processing technology. The technology analyzes the video images to detect the obvious changes such as moving objects and blurriness. The system activates alarms when such changes are detected.

5.10.4.1 Configuring Motion Detection Settings

When the moving object appears and moves fast enough to reach the preset sensitivity value, the system activates the alarm.





Step 1 Select **Main Menu > ALARM > Video Detection > Motion Detection**.



Figure 5-134 Motion

Step 2 Configure the settings for the motion detection parameters.

Table 5-31 Motion detection parameters

Parameter	Description
Channel	In the Channel list, select a channel to set the motion detection.
Region	Click Setting to define the motion detection region.
Enable	Enable or disable the motion detection function.
PIR Alarm	<p>PIR function helps enhancing the accuracy and validity of motion detect. It can filter the meaningless alarms that are activated by the objects such as falling leaves, flies. The detection range by PIR is smaller than the field angle.</p> <p>PIR function is enabled by default if it is supported by the cameras. Enabling PIR function will get the motion detect to be enabled automatically to generate motion detection alarms; if the PIR function is not enabled, the motion detect just has the general effect.</p>  <ul style="list-style-type: none"> • Only when the channel type is CVI, the PIR function can be enabled. • If the camera does not support PIR function, it will be unusable. • If the Device does not support PIR function, it will not be displayed on the page.
Schedule	Define a period during which the motion detection is active.
Anti-Dither	Configure the time period from end of event detection to the stop of alarm.

Parameter	Description
Alarm-out Port	<p>Click Setting to display setting page.</p> <ul style="list-style-type: none"> ● General Alarm: Enable alarm activation through the alarm devices connected to the selected output port. ● External Alarm: Enable alarm activation through the connected alarm box. ● Wireless Siren: Enable alarm activation through devices connected by USB gateway or camera gateway.
Post-Alarm	<p>Set a length of time for the Device to delay turning off alarm after the external alarm is cancelled. The value ranges from 0 seconds to 300 seconds, and the default value is 10 seconds. If you enter 0, there will be no delay.</p>
Show Message	<p>Select the Show Message checkbox to enable a pop-up message in your local host PC.</p>
Report Alarm	<p>Select the Report Alarm checkbox to enable the system to upload the alarm signal to the network (including alarm center) when an alarm event occurs.</p>
Send Email	<p>Select the Send Email checkbox to enable the system to send an email notification when an alarm event occurs.</p>  <p>To use this function, make sure the email function is enabled in Main Menu > NETWORK > Email.</p>
Record Channel	<p>Select the channel(s) that you want to record. The selected channel(s) starts recording after an alarm event occurs.</p>  <p>The recording for motion detection and auto recording function must be enabled. For details, see "5.1.4.9 Configuring Recorded Video Storage Schedule" and "5.9.1 Enabling Record Control".</p>
PTZ Linkage	<p>Click Setting to display the PTZ page.</p> <p>Enable PTZ linkage actions, such as selecting the preset that you want to be called when an alarm event occurs.</p>  <p>Motion Detect can only activate PTZ preset.</p>
Post Record	<p>Set a length of time for the Device to delay turning off recording after the alarm is cancelled. The value ranges from 10 seconds to 300 seconds, and the default value is 10 seconds.</p>
Tour	<p>Select the Tour checkbox to enable a tour of the selected channels.</p>
Picture Storage	<p>Select the Snapshot checkbox to take a snapshot of the selected channel.</p>  <p>To use this function, select Main Menu > CAMERA > Encode > Snapshot, in the Type list, select Event.</p>

Parameter	Description
Sub Screen	Select the checkbox to enable the function. When an alarm event occurs, the extra screen outputs the settings configured in Main Menu > DISPLAY > Tour > Sub Screen .  <ul style="list-style-type: none"> • Not all models support this function. • To use this function, extra screen shall be enabled.
Video Matrix	Select the checkbox to enable the function. When an alarm event occurs, the video output port outputs the settings configured in Main Menu > DISPLAY > Tour .  Not all models support this function.
Buzzer	Select the checkbox to activate a buzzer noise at the Device.
Log	Select the checkbox to enable the Device to record a local alarm log.
Alarm Tone	Select to enable audio broadcast/alarm tones in response to a motion detection event.
Warning Light	Select the checkbox to enable warning light alarm of the camera.
Siren	Select the checkbox to enable sound alarm of the camera.

Step 3 Click **Apply** to save the settings.



- Click **Default** to restore the default setting.
- Click **Copy to**, in the **Copy to** dialog box, select the additional channel(s) that you want to copy the motion detection settings to, and then click **Apply**.
- Click **Test** to test the settings.

Setting the Motion Detection Region

Step 1 Next to **Region**, click **Setting**.

Step 2 Point to the middle top of the page.

Figure 5-135 Detection setting



Step 3 Configure the regions settings. You can configure totally four regions.

- 1) Select one region, for example, click .
- 2) Drag on the screen to select the region that you want to detect. The selected area shows the color that represents the region.
- 3) Configure the parameters.

Table 5-32 Motion detection parameters

Parameter	Description
Name	Enter a name for the region.
Sensitivity	Every region of every channel has an individual sensitivity value. The bigger the value is, the easier the alarms can be activated.
Threshold	Adjust the threshold for motion detect. Every region of every channel has an individual threshold.



When anyone of the four regions activates motion detect alarm, the channel where this region belongs to will activate motion detect alarm.

Step 4 Right-click on the screen to exit the region setting page.

Step 5 On the **Motion Detection** page, click **Apply** to complete the settings.

Setting Motion Detection Period





The system only activates the alarm in the defined period.

Step 1 Next to **Schedule**, click **Setting**.

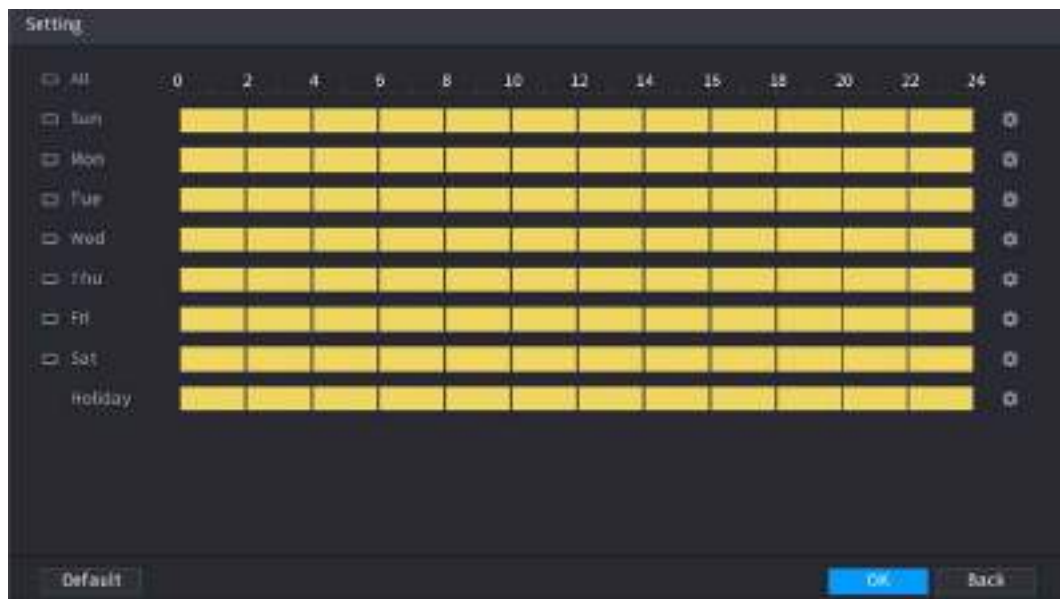
Figure 5-136 Setting



Step 2 Define the motion detection period. By default, it is active all the time.

- Define the period by drawing.
 - ◇ Define for a specified day of a week: On the timeline, click the half-hour blocks to select the active period.
 - ◇ Define for several days of a week: Click  before each day, the icon switches to . On the timeline of any selected day, click the half-hour blocks to select the active periods, all the days with  will take the same settings.

- ◇ Define for all days of a week: Click **All**, all switches to . On the timeline of any day, click the half-hour blocks to select the active periods, all the days will take the same settings.
- Define the period by editing. Take Sunday as an example.

1) Click

Figure 5-137 Period

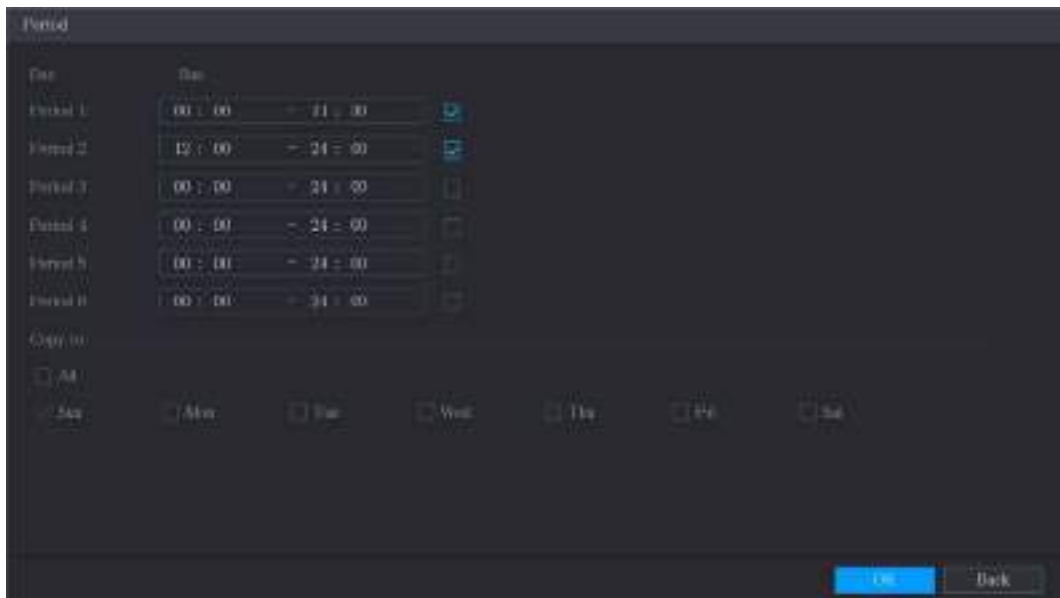

- 2) Enter the time frame for the period, and then select the checkbox to enable the settings.
 - ◇ There are six periods for you to set for each day.
 - ◇ Under **Copy to**, select **All** to apply the settings to all the days of a week, or select specific day(s) that you want to apply the settings to.
- 3) Click **OK** to save the settings.

Step 3 On the **Motion Detection** page, click **Apply** to complete the settings.

5.10.4.2 Configuring Video Loss Settings

When the video loss occurs, the system activates the alarm.

Step 1 Select **Main Menu > ALARM > Video Detection > Video Loss**.

Figure 5-138 Video loss

Motion Detection	Video Loss	Video Tampering	Video Quality An...
Channel	1		
Enable	<input type="checkbox"/>		
Schedule	Setting	CAM AntiDither	0 sec.
Alarm-out Port	Setting	Post-Alarm	10 sec.
<input type="checkbox"/> Show Message	<input checked="" type="checkbox"/> Report Alarm	<input type="checkbox"/> Send Email	
<input type="checkbox"/> Record Channel	Setting	Post-Record	10 sec.
<input type="checkbox"/> PTZ Linkage	Setting	<input type="checkbox"/> Picture Storage	Setting
<input type="checkbox"/> Tour	Setting		
<input type="checkbox"/> Buzzer	<input checked="" type="checkbox"/> Log		
<input type="checkbox"/> Alarm Tone	None		
Default		Copy to	
		Apply	
		Back	

Step 2 To configure the settings for the video loss detection parameters, see "5.10.4.1 Configuring Motion Detection Settings".



For PTZ activation, different from motion detection, the video loss detection can activate PTZ preset, tour, and pattern.

Step 3 Click **Apply** to complete the settings.



- Click **Default** to restore the default setting.
- Click **Copy to**, in the **Copy to** dialog box, select the additional channel(s) that you want to copy the motion detection settings to, and then click **Apply**.

5.10.4.3 Configuring Tampering Settings

When the camera lens is covered, or the video is displayed in a single color because of the causes such as sunlight status, the monitoring cannot be continued normally. To avoid such situations, you can configure the tampering alarm settings.

Step 1 Select **Main Menu > ALARM > Video Detection > Video Tampering**.

Figure 5-139 Video tampering

Motion Detection	Video Loss	Video Tampering	Video Quality An...
Channel	1		
Enable	<input type="checkbox"/>	Sensitivity	3
Schedule	Setting	CAM AntiDither	0 sec.
Alarm-out Port	Setting	Post-Alarm	10 sec.
<input type="checkbox"/> Show Message	<input checked="" type="checkbox"/> Report Alarm	<input type="checkbox"/> Send Email	
<input type="checkbox"/> Record Channel	Setting	Post-Record	10 sec.
<input type="checkbox"/> PTZ Linkage	Setting	<input type="checkbox"/> Picture Storage	Setting
<input type="checkbox"/> Tour	Setting		
<input type="checkbox"/> Buzzer	<input checked="" type="checkbox"/> Log		
<input type="checkbox"/> Alarm Tone	None		
Default		Copy to	Apply Back

Step 2 To configure the settings for the tampering detection parameters, see "5.10.4.1 Configuring Motion Detection Settings".



For PTZ activation, different from motion detection, the video loss detection can activate PTZ preset, tour, and pattern.

Step 3 Click **Apply** to complete the settings.



- Click **Default** to restore the default setting.
- Click **Copy to**, in the **Copy to** dialog box, select the additional channel(s) that you want to copy the motion detection settings to, and then click **Apply**.

5.10.5 System Events

You can configure the alarm output for three types of system event (HDD, Network, and User). When there is an abnormal system event occurs, the system activates alarms in the way that you configure in this section.

5.10.5.1 Configuring HDD Event Settings

Step 1 Select **Main Menu > ALARM > Exception > Disk**.

Figure 5-140 Disk

Step 2 Configure the settings for the HDD event.

Table 5-33 HDD event settings

Parameter	Description
Event Type	In the Event Type list, select No Disk , Disk Error , or Low Space as the event type.
Enable	Enable or disable the HDD event detection function.
Alarm-out Port	Click Setting to display setting page. <ul style="list-style-type: none"> Local Alarm: Enable alarm activation through the alarm devices connected to the selected output port. Extension Alarm: Enable alarm activation through the connected alarm box. Wireless Siren: Enable alarm activation through devices connected by USB gateway or camera gateway.
Post-Alarm	Set a length of time for the Device to delay turning off alarm after the external alarm is cancelled. The value ranges from 10 seconds to 300 seconds, and the default value is 10 seconds.
Show Message	Select the Show Message checkbox to enable a pop-up message in your local host PC.
Report Alarm	Select the Report Alarm checkbox to enable the system to upload the alarm signal to the network (including alarm center) when an alarm event occurs.
Send Email	Select the Send Email checkbox to enable the system to send an email notification when an alarm event occurs.  To use this function, make sure the email function is enabled in Main Menu > NETWORK > Email .
Buzzer	Select the checkbox to activate a buzzer noise at the Device.

Parameter	Description
Log	Select the checkbox to enable the Device to record a local alarm log.
Alarm Tone	Select to enable audio broadcast/alarm tone in response to a HDD alarm event.

Step 3 Click **Apply** to complete the settings.

5.10.5.2 Configuring Network Event Settings

Step 1 Select **Main Menu > ALARM > Exception > Network**.

Figure 5-141 Network

Step 2 Configure the settings for the Network event.

Table 5-34 Network event settings

Parameter	Description
Event Type	In the Event Type list, select Office , IP Conflict , or MAC Conflict as the event type.
Enable	Enable or disable the Network event detection function.
Alarm-out Port	Click Setting to display setting page. <ul style="list-style-type: none"> ● General Alarm: Enable alarm activation through the alarm devices connected to the selected output port. ● External Alarm: Enable alarm activation through the connected alarm box. ● Wireless Siren: Enable alarm activation through devices connected by USB gateway or camera gateway.
Post-Alarm	Set a length of time for the Device to delay turning off alarm after the external alarm is cancelled. The value ranges from 10 seconds to 300 seconds, and the default value is 10 seconds.

Parameter	Description
Show Message	Select the Show Message checkbox to enable a pop-up message in your local host PC.
Send Email	Select the Send Email checkbox to enable the system to send an email notification when an alarm event occurs.  To use this function, make sure the email function is enabled in Main Menu > NETWORK > Email .
Buzzer	Select the checkbox to activate a buzzer noise at the Device.
Log	Select the checkbox to enable the Device to record a local alarm log.
Post Record	Continue to record for some time after the alarm is ended. The value ranges from 10 seconds to 300 seconds.
Alarm Tone	Select to enable audio broadcast/alarm tones in response to a network alarm event.

Step 3 Click **Apply** to complete the settings.

5.10.6 Configuring Disarming

You can disarm all alarm linkage actions as needed.

Step 1 Select **Main Menu > ALARM > Disarming**.

Step 2 Click  to enable disarming.

Figure 5-142 Disarming

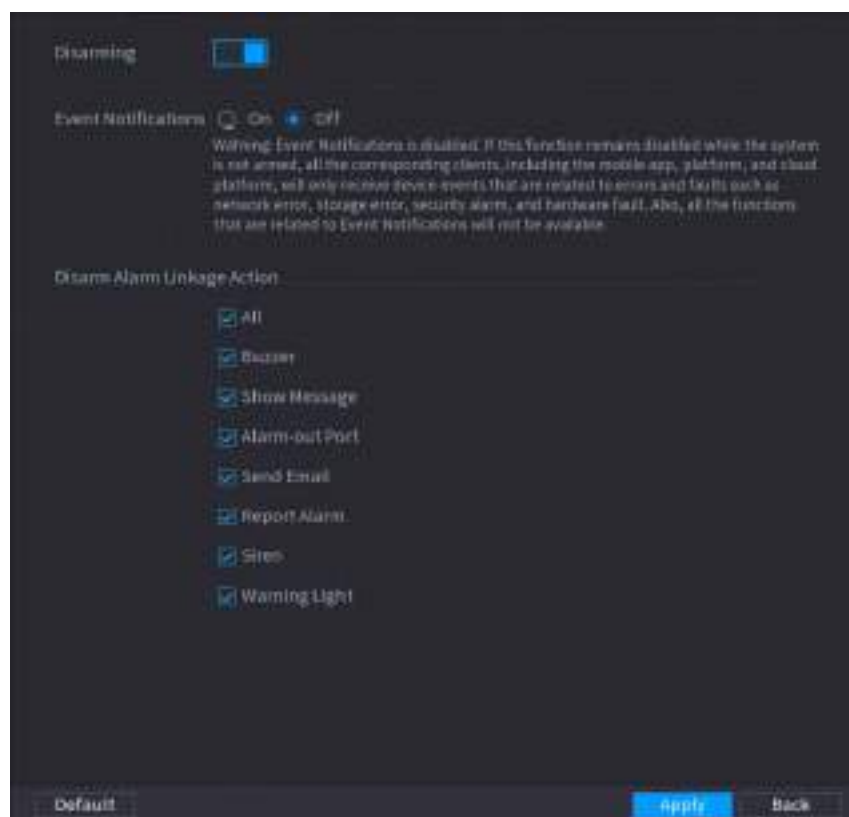

Step 3 (Optional) Select **Off** to disable event notifications.

With **Disarming** enabled, if you disable event notifications, event notifications will not be pushed to the clients including the mobile app, platform and cloud platform.

Step 4 Select alarm linkage actions to disarm.



All alarm linkage actions will be disarmed when you select **All**.

Step 5 Click **Apply**.

5.11 AI Function

5.11.1 Configuring AI Mode

To use AI functions, you need to enable the corresponding AI mode.

Step 1 Select **Main Menu > AI > Parameters > AI Mode**.

Figure 5-143 AI mode

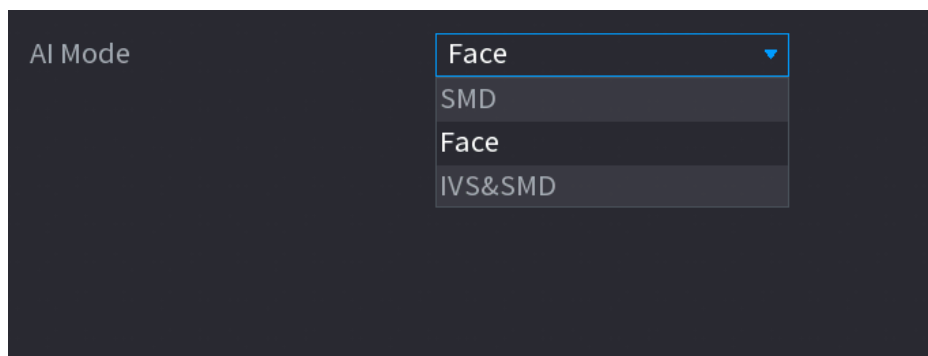

Step 2 Select an AI mode

- When **SMD** is selected, only SMD is available.
- When **Face** is selected, only face detection and face recognition are available.
- When **IVS&SMD** is selected, only IVS and SMD are available.



SMD, face detection, face recognition and IVS cannot be enabled simultaneously.

5.11.2 For Pro AI Series



The faces are fuzzily processed to comply with relevant regulations.

AI module provides face detection, face recognition, IVS functions, and video structuring. These functions take effect after they are configured and enabled. It adopts deep learning and can realize precision alarms.

- **Face detection:** The Device can analyze the faces captured by the camera and link the configured alarms.
- **Face recognition:** The Device can compare the captured faces with the face database and then link the configured alarms.
- **IVS:** The IVS function processes and analyzes the human and vehicle images to extract the key information to match with the preset rules. When the detected behaviors match with the rules,

the system activates alarms. The IVS function can avoid wrong alarms by filtering the factors such as rains, light, and animals.

- Video structuring: The device can detect and extract key features from the human bodies and non-motor vehicles in the video, and then build a structured database. You can search any target you need with these features. For example, you can search any people who wears yellow short sleeve shirt. See more details in "5.11.1.4 Video Structuring".

5.11.2.1 Face Detection

The Device can analyze the pictures captured by the camera to detect whether the faces are on the pictures. You can search and filter the recorded videos the faces and play back.



If you select AI by device, then among face detection and recognition, IVS function, and video structuring, you can use one of them at the same time for the same channel.

5.11.2.1.1 Configuring Face Detection Parameters

The alarms are generated according to the configured parameters.

Step 1 Main Menu > AI > Parameters > Face Detection.



Figure 5-144 Face detection





The screenshot displays the configuration page for Face Detection on Channel 1. The 'Enable' checkbox is checked. The 'Rule' is set to 'Setting'. The 'Schedule' is also set to 'Setting'. The 'Alarm-out Port' is set to 'Setting'. The 'Record Channel' checkbox is checked. The 'PTZ Linkage' checkbox is unchecked. The 'Tour' checkbox is unchecked. The 'Buzzer' checkbox is unchecked, and the 'Log' checkbox is checked. The 'Alarm Tone' is set to 'None'. The 'Warning Light' checkbox is checked, and the 'Siren' is set to 'alarm'. The 'Smart Illumination' checkbox is checked. The 'Post-Alarm' is set to 10 seconds, and the 'Report Alarm' checkbox is checked. The 'Post-Record' is set to 10 seconds. At the bottom, there are buttons for 'Default', 'Apply', and 'Back'.

Step 2 In the **Channel** list, select a channel that you want to configure face detection function, and then enable it.

Step 3 Configure the parameters.

Table 5-35 Face detection parameters

Parameter	Description
Type	<p>You can select from AI by Camera and AI by Device.</p> <ul style="list-style-type: none"> ● AI by Camera: This option requires certain AI cameras. The camera will do all the AI analysis, and then give the results to the DVR. ● AI by Device: The camera only transmits normal video stream to the DVR, and then the DVR will do all the AI analysis.
Rule	<p>Click View Setting to draw areas to filter the target.</p> <p>You can configure two filtering targets (maximum size and minimum size). When the target is smaller than the minimum size or larger than the maximum size, no alarms will be activated. The maximum size should be larger than the minimum size.</p>
Schedule	<p>Define a period during which the detection is active.</p> <p>For details, see "Setting Motion Detection Period" section in "5.10.4.1 Configuring Motion Detection Settings".</p>
Alarm-out Port	<p>Click Setting to display setting page.</p> <ul style="list-style-type: none"> ● General Alarm: Enable general alarm and select the alarm output port. ● Ext. Alarm: Connect the alarm box to the Device and then enable it. ● Wireless Siren: Connect the wireless gateway to the Device and then enable it. For details, see "5.12 IoT Function". <p>When an alarm event occurs, the system links the peripheral alarm devices connected to the selected output port.</p>
Post-Alarm	<p>Set a length of time for the Device to delay turning off alarm after the external alarm is cancelled. The value ranges from 0 seconds to 300 seconds. If you enter 0, there will be no delay.</p>
Show Message	<p>Select the Show Message checkbox to enable a pop-up alarm message in your local host PC.</p>
Report Alarm	<p>Select the Report Alarm checkbox to enable the system to upload the alarm signal to the network (including alarm center) when an alarm event occurs.</p>  <ul style="list-style-type: none"> ● Not all models support this function. ● The corresponding parameters in the alarm center should be configured. For details, see "5.15.1.12 Configuring Alarm Center Settings".
Send Email	<p>Select the Send Email checkbox to enable the system to send an email notification when an alarm event occurs.</p>  <p>To use this function, make sure the email function is enabled in Main Menu > NETWORK > Email.</p>

Parameter	Description
Record Channel	<p>Select the channel(s) that you want to record. The selected channel(s) starts recording after an alarm event occurs.</p>  <p>The recording for intelligence event and auto recording function must be enabled. For details, see "5.1.4.9 Configuring Recorded Video Storage Schedule" and "5.9.1 Enabling Record Control".</p>
PTZ Linkage	<p>Click Setting to display the PTZ page.</p> <p>Enable PTZ linkage actions, such as selecting the preset that you want to be called when an alarm event occurs.</p>  <p>To use this function, the PTZ operations must be configured. For details, see "5.4 Controlling PTZ Cameras".</p>
Post Record	<p>Set a length of time for the Device to delay turning off recording after the alarm is cancelled. The value ranges from 10 seconds to 300 seconds.</p>
Tour	<p>Select the Tour checkbox to enable a tour of the selected channels.</p>  <ul style="list-style-type: none"> To use this function, the tour setting must be configured. After the tour is ended, the live view screen returns to the view layout before tour started.
Picture Storage	<p>Select the Picture Storage checkbox to take a snapshot of the selected channel.</p>  <p>To use this function, make sure the snapshot function is enabled for Intel in Main Menu > STORAGE > Schedule > Snapshot.</p>
Video Matrix	<p>Select the checkbox to enable the function. When an alarm event occurs, the video output port outputs the settings configured in "Main Menu > DISPLAY > TOUR > Extra Screen".</p>  <ul style="list-style-type: none"> Not all models support this function. The extra screen must be enabled to support this function.
Buzzer	<p>Select the checkbox to activate a buzzer noise at the Device.</p>
Log	<p>Select the checkbox to enable the Device to record a local alarm log.</p>
Alarm Tone	<p>Select to enable audio broadcast in response to a face detection event.</p>
Warning Light	<p>Select the checkbox to enable the warning light alarm of the camera.</p>
Siren	<p>Select the checkbox to enable the sound alarm of the camera.</p>
Smart Illumination	<p>Select the checkbox to enable the smart illumination of the camera.</p>

Step 4 Click **Apply** to complete the settings.

5.11.2.1.2 Searching for and Playing Detected Faces

You can search the detected faces and play back.

Step 1 Select **Main Menu > AI > AI Search > Face Detection**.

Figure 5-145 Face detection

Channel	1
Start Time	2020 -03 -02 00 :00 :00
End Time	2020 -03 -03 00 :00 :00
Gender	All
Age	All
Glasses	All
Beard	All
Mouth Mask	All
Expression	All
Smart Search	

Step 2 Select the channel, enter the start time and end time, and set for the gender, age, glasses, beard, and mask.

Step 3 Click **Smart Search**.

The results are displayed.

Figure 5-146 Search results

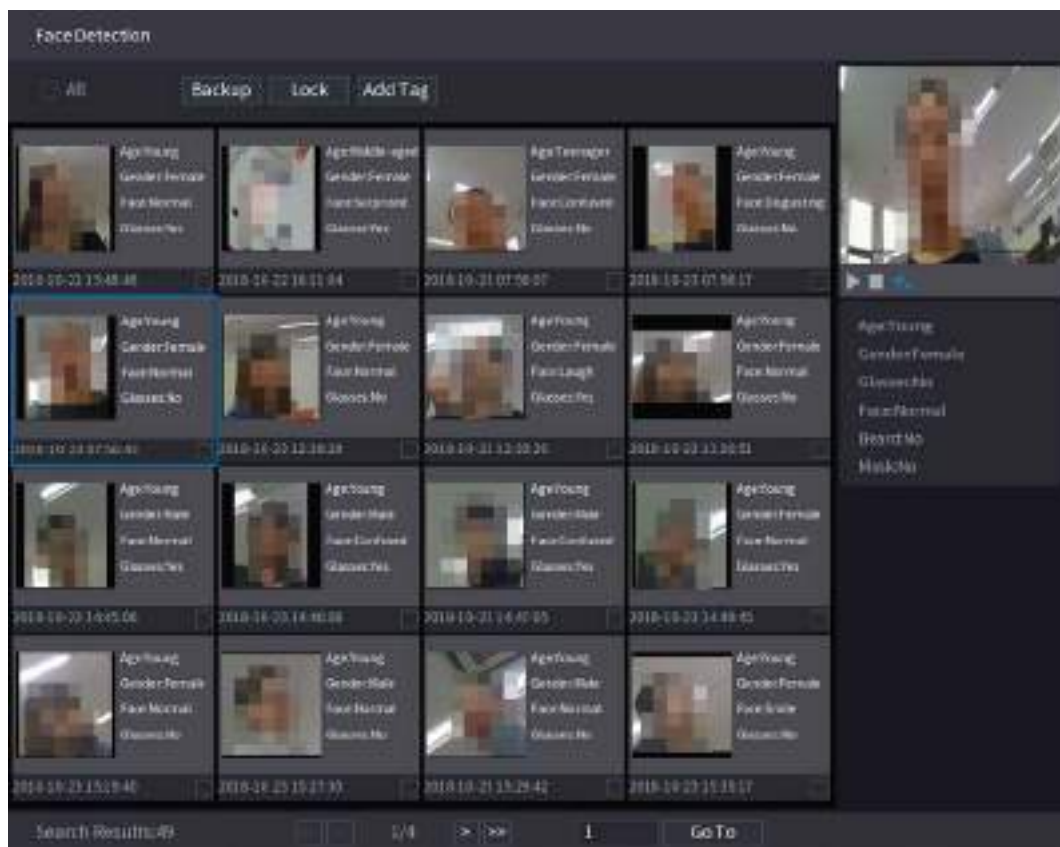

Step 4 Select the face that you want to play back.

Figure 5-147 Registered information

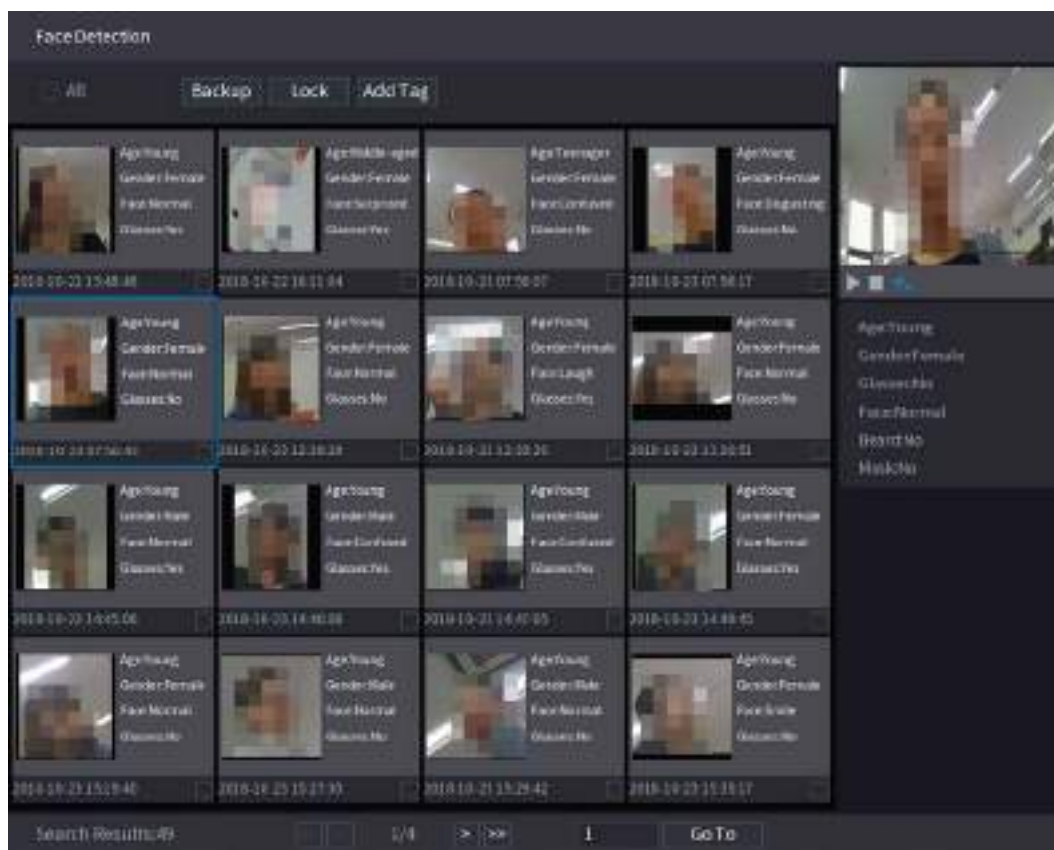

Step 5 Click  to start playing back the recorded detected face snapshots.



Double-click on the playing page to switch between full screen playing and thumbnail playing.

You can also do the following operations to the recorded files.

- To export the database file (.csv) to the external storage device, select files, click **Export**, and then select the save path.
- To back up the recorded files to the external storage device, select files, click **Backup**, select the save path and file type, and then click **Start**.

Figure 5-148 Backup

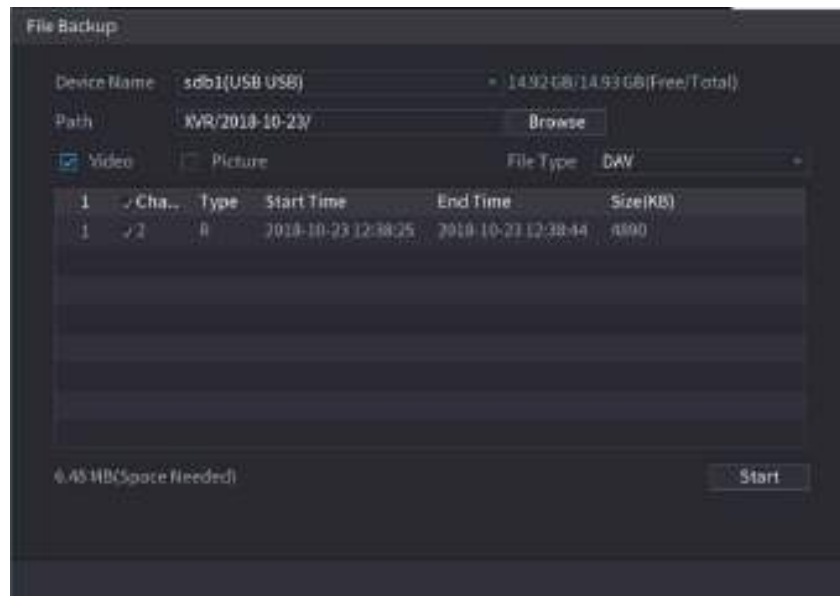

- To lock the files to make it unable to be overwritten, select the files, and then click **Lock**.
- To add a mark to the file, select the files and then click **Add Tag**.

5.11.2.2 Face Recognition

Face recognition applies to AI preview mode and smart search.

- AI preview mode: Supports comparing the detected faces with the face database, and display the comparison results.
- Smart search: Supports faces searching by faces attributes or portraits.



- If you select AI by device, then among face detection and recognition, IVS function, and video structuring, you can use one of them at the same time for the same channel.
- Before enabling face recognition function for a channel, the face detection must be enabled first for this channel.

5.11.2.2.1 Face Database Management

You should create a face database for comparing the detected faces and the faces in the database. The Device supports creating maximum 20 databases and registering 100,000 faces.

Creating a Face Database

Step 1 Select **Main Menu > AI > Database > Face Database Config**.

Figure 5-149 Face database configuration

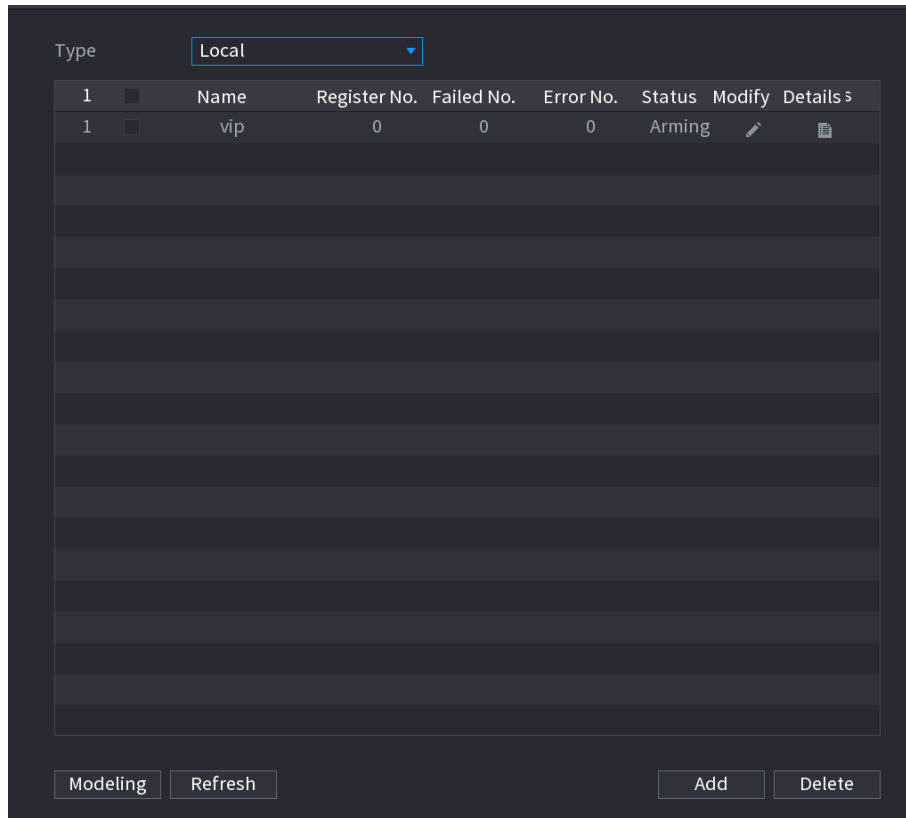

Step 2 At **Type**, you can select **Local** or **Remote**.

- **Local**: Viewing the existing face databases or adding new one on the DVR.
- **Remote**: If you have face recognition camera, you can select this to view the existing face databases or adding new one on the camera.

Step 3 Click **Add**.

Figure 5-150 Add face database

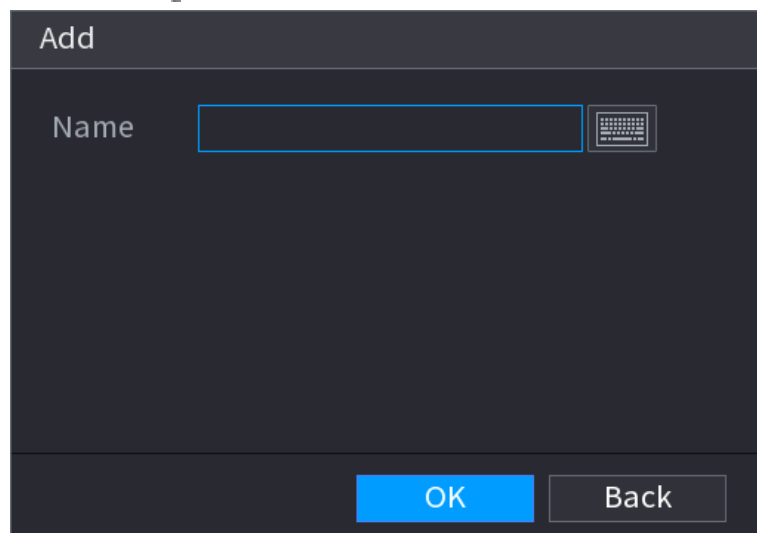

Step 4 Enter the face database name, and then click **OK**.

- Click to modify database name.

- Click  to view the database details and add new faces to the database. For details, see " Adding Face Pictures".
- Select the database, and then click **Modeling**. The system will extract the attributes of face pictures in the database for the future comparison.
- Select the database, and then click **Delete** to delete the database.

Figure 5-151 Configure database



Adding Face Pictures

You can add face pictures to the existing databases one by one or by batch, or add from the detected faces.

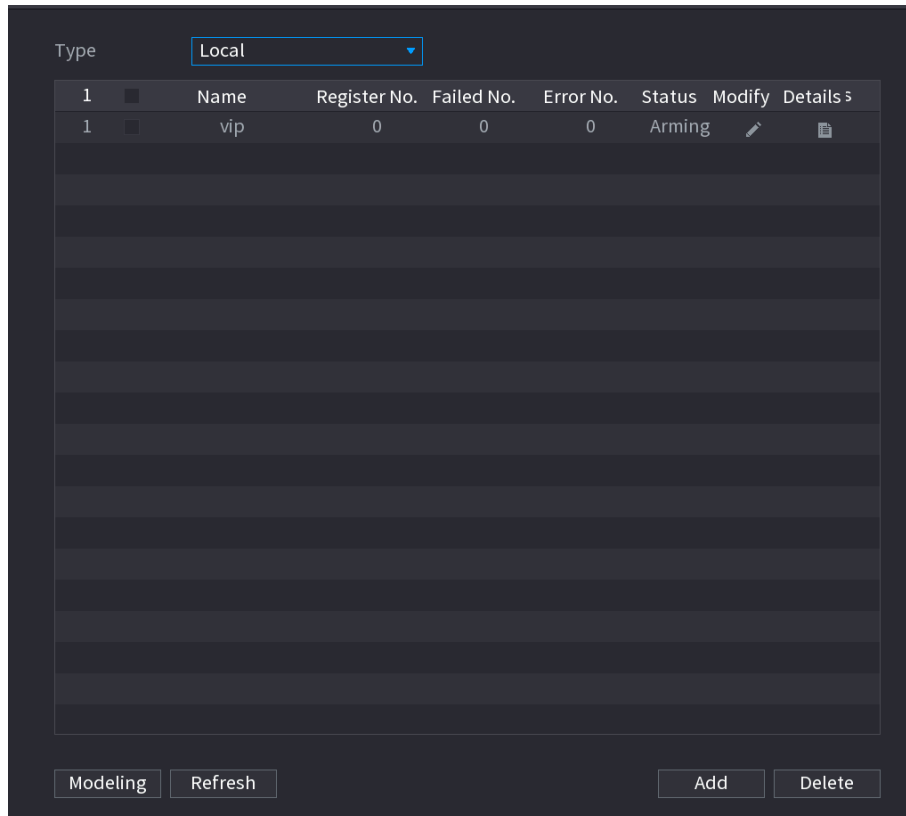

To add face pictures one by one or by batch, you need to get the pictures from the USB storage device. The picture size should be smaller than 256K with resolution between 200 × 200–6000 × 5000.

Adding One Face Picture

Step 1 Select **Main Menu > AI > Database > Face Database Config**.

Step 2 Click  of the database that you want to configure.

Figure 5-152 Details

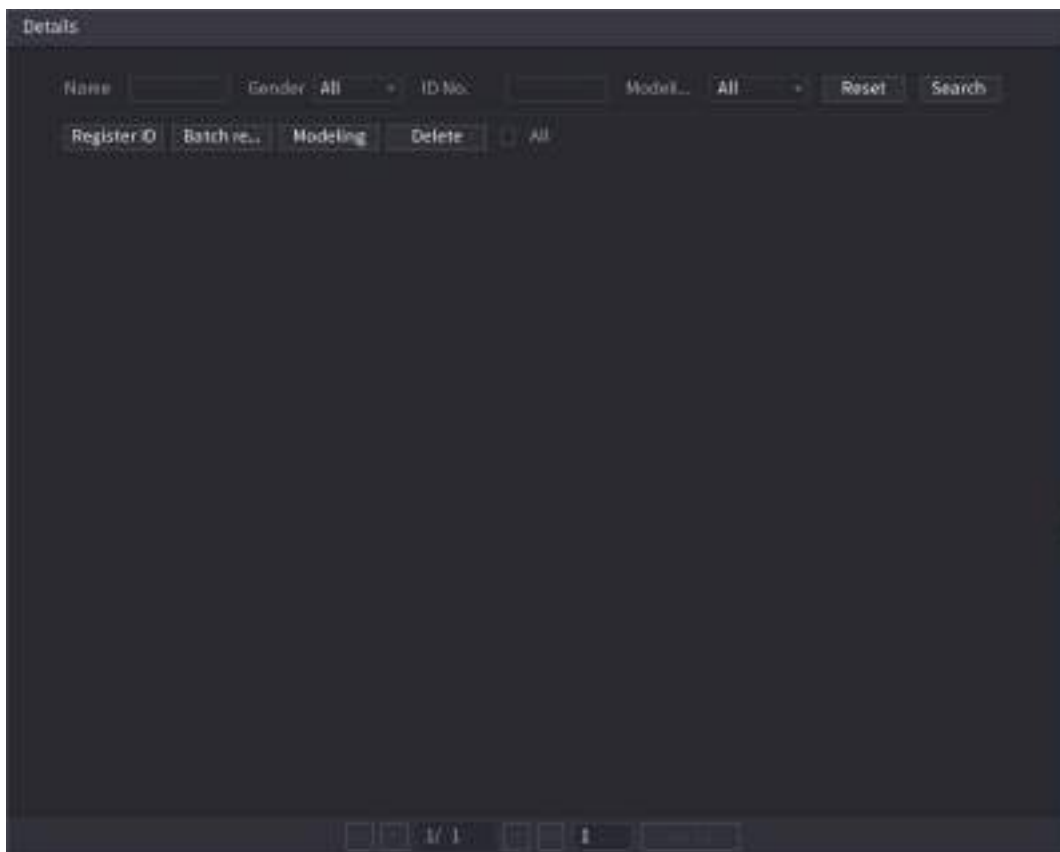

Step 3 Click **Register ID**.

Figure 5-153 Register ID

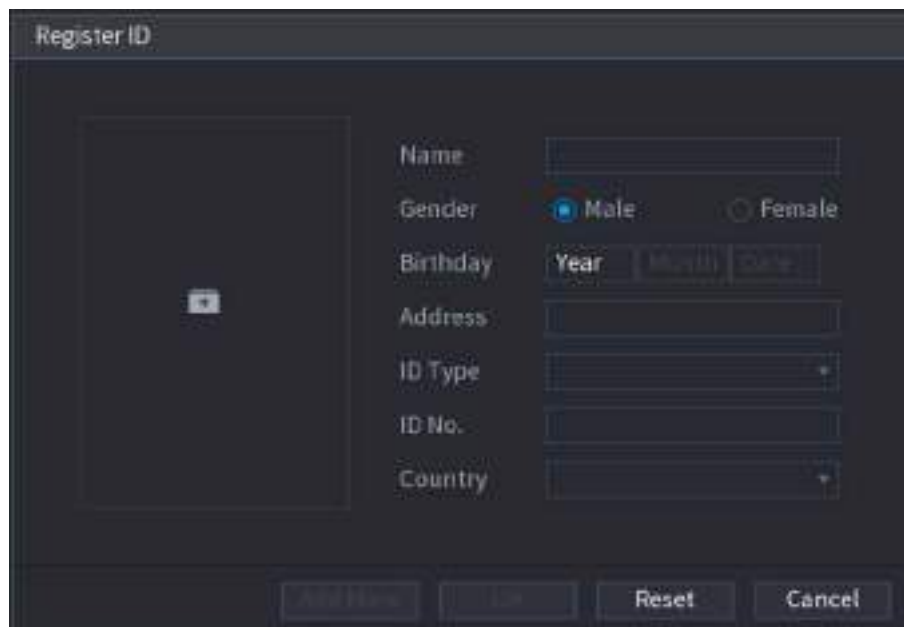

Step 4 Click  to add a face picture.

Figure 5-154 Browse

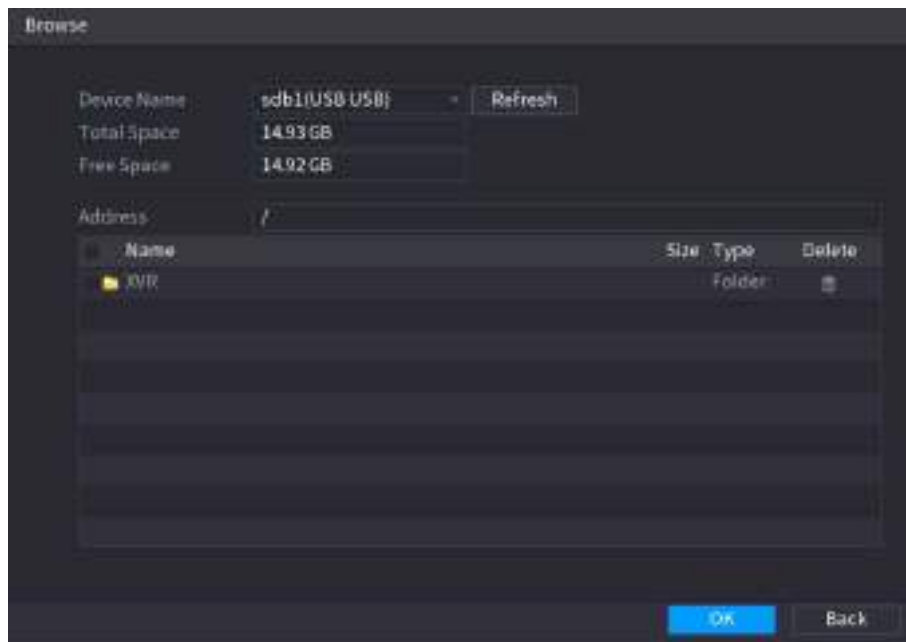

Step 5 Select a face picture and enter the registration information.

Figure 5-155 Register ID

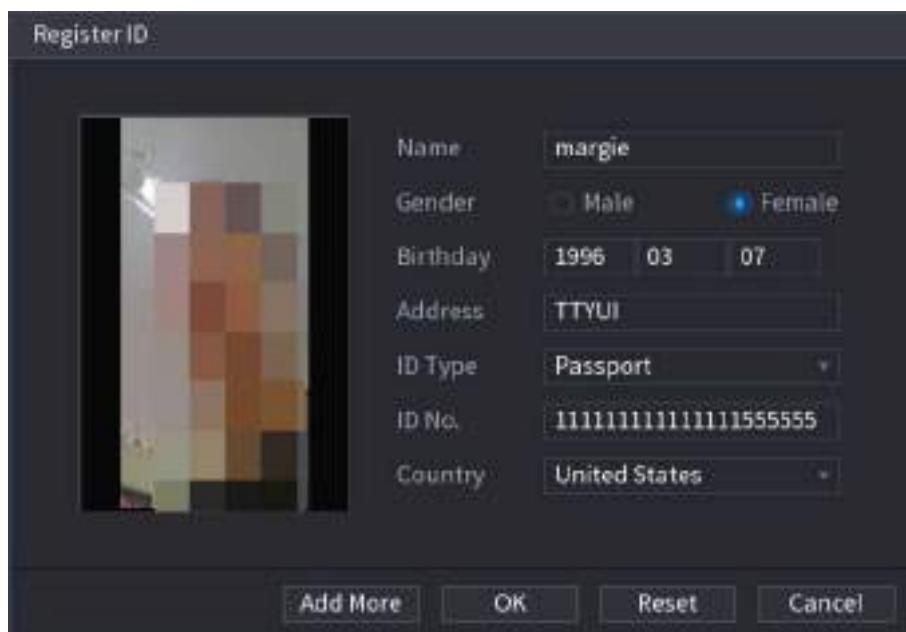

Step 6 Click **OK**.

The system prompts the registration is successful.

Step 7 On the **Details** page, click **Search**.

The system prompts modeling is successful.



If the system prompts the message indicating modeling is in process, wait a while and then click **Search** again. If modeling is failed, the registered face picture cannot be used for face recognition.

Figure 5-156 Details

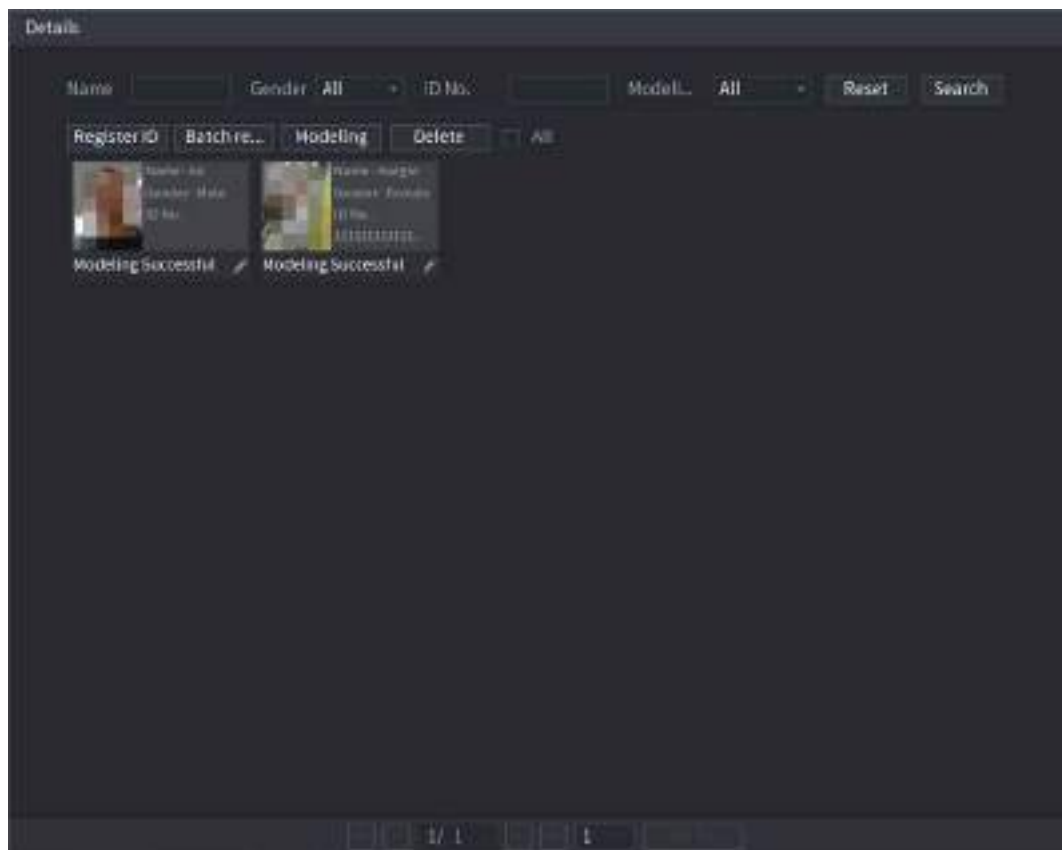

Adding Face Pictures in Batch

Step 1 Give a name to the face picture.

Table 5-36 Register ID

Naming format	Description
Name	Enter the name.
Gender	Enter 1 or 2. 1 represents male, and 2 represents female.
Birthday	Enter numbers in the format of yyyy-mm-dd.
Country	Enter the abbreviation of country. For example, CN for China.
ID Type	1 represents ID card; 2 represents passport; 3 represents officer password.
ID No.	Enter the ID number.
Address	Enter the address.

Step 2 On the **Details** page, click **Batch register**.

Figure 5-157 Batch register

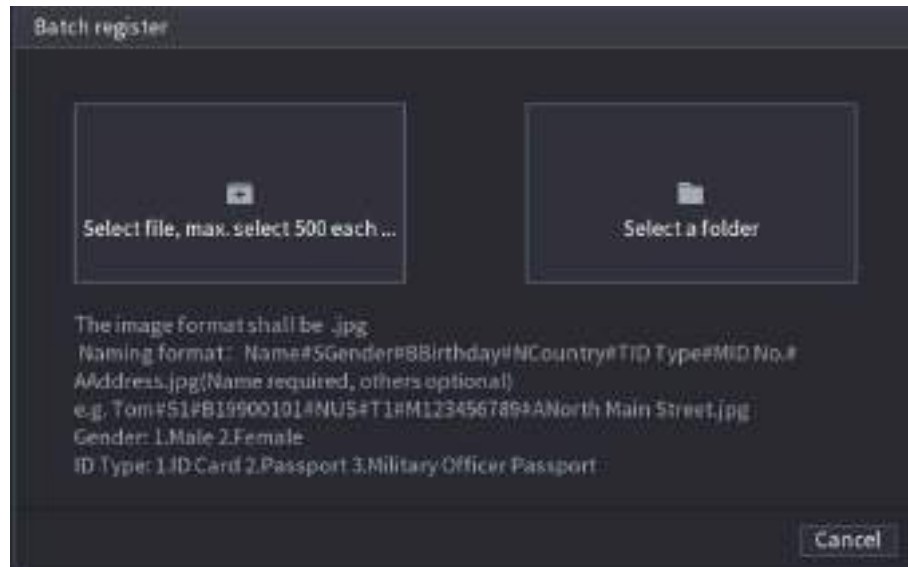

Step 3 Click **Select file, max select 500 each time** or **Select a folder** to import face pictures.

Step 4 Click **OK** to complete batch registration.

Adding the Detected Faces

Step 1 Right-click on the live view screen, and then select **Live Mode > AI Mode**.

Figure 5-158 AI mode live view

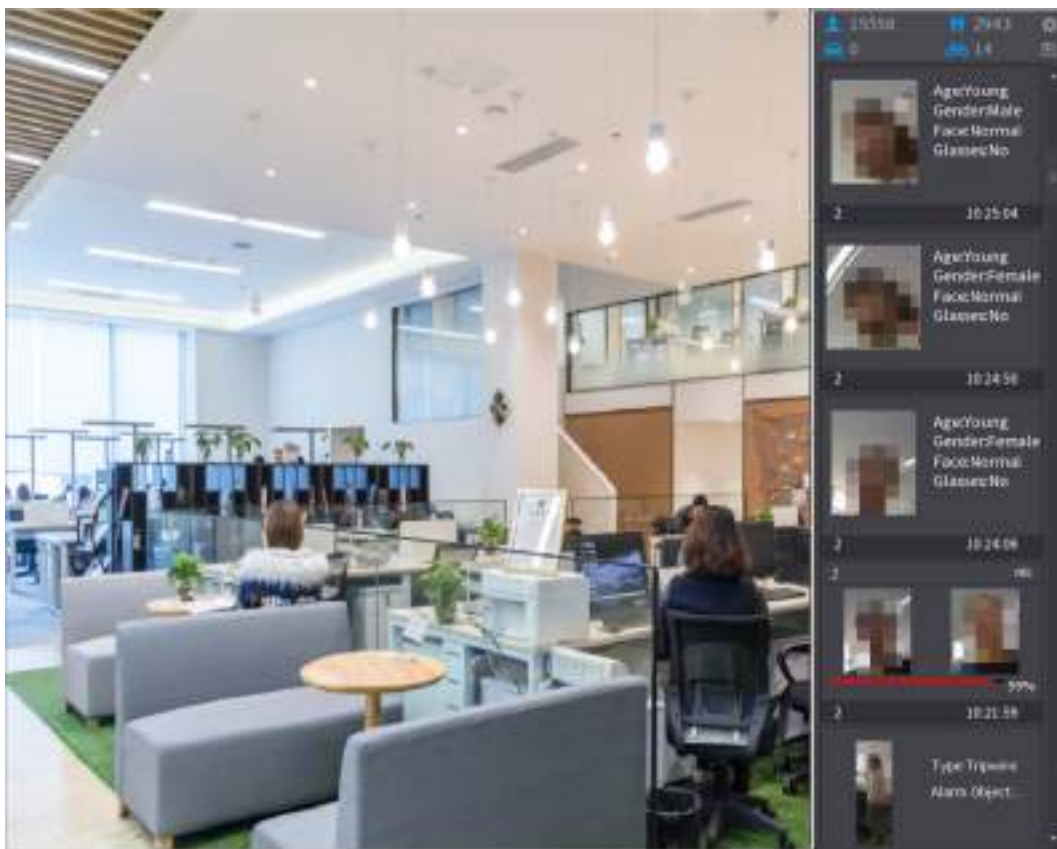

Step 2 Double-click the detected face snapshot that you want to add.

Figure 5-159 Playback

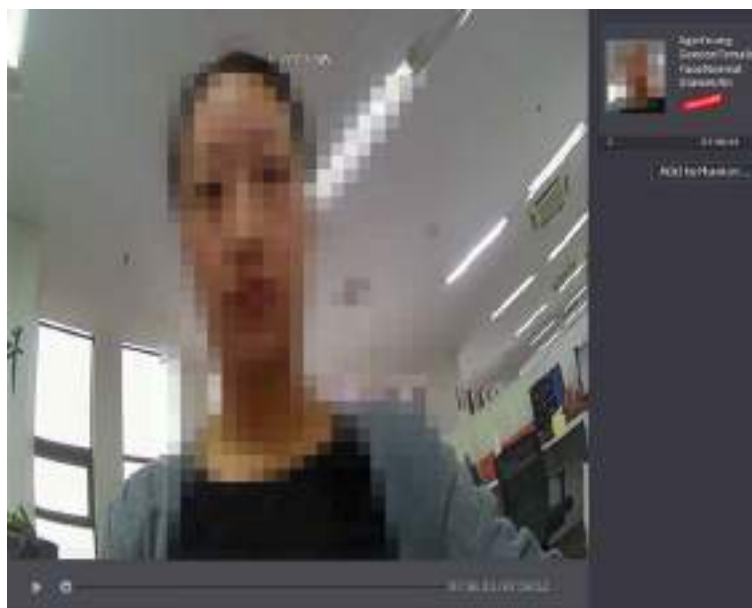

Step 3 Click **Add to Human Face Database**.

Figure 5-160 Register ID

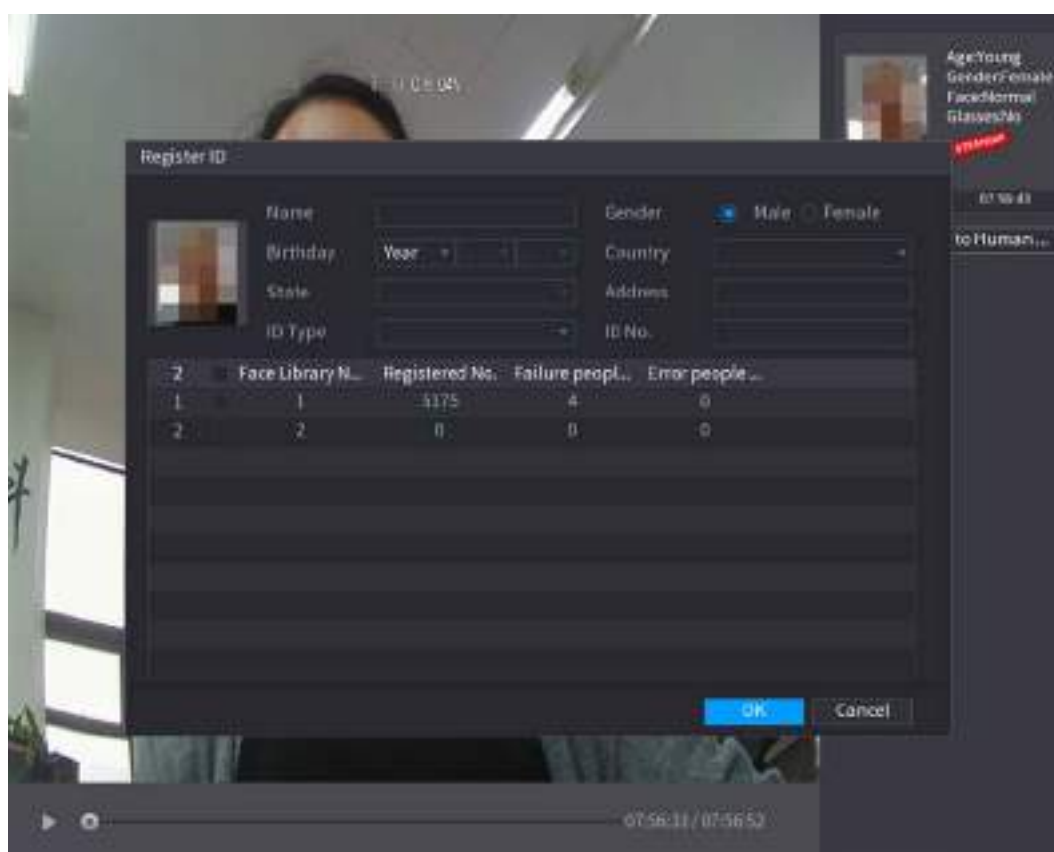

Step 4 Select the face database and enter the ID information.

Step 5 Click **OK** to complete registration.

5.11.2.2.2 Face Recognition Configuration

You can compare the detected faces with the faces in the database to judge if the detected face belongs to the database. The comparison result will be displayed on the AI mode live view screen and smart search page, and link the alarms.

Step 1 Select **Main Menu > AI > Parameters > Face Recognition**.

Figure 5-161 Face recognition

0	Enable	Name	Similarity	Modify	Parameters	Delete

Step 2 In the **Channel** list, select a channel that you want to configure face recognition function, and then enable it.

Step 3 Set the **Schedule**. For details, see "5.10.4.1 Configuring Motion Detection Settings".

Step 4 Set the **Target Face Database**.

1) Click **Setting**.

Figure 5-162 Face database

0	Name	Register No.	Failed No.	Error No.

- 2) Select one or multiple face databases.
- 3) Click **OK**.
The selected face database is listed.

Figure 5-163 Selected face database

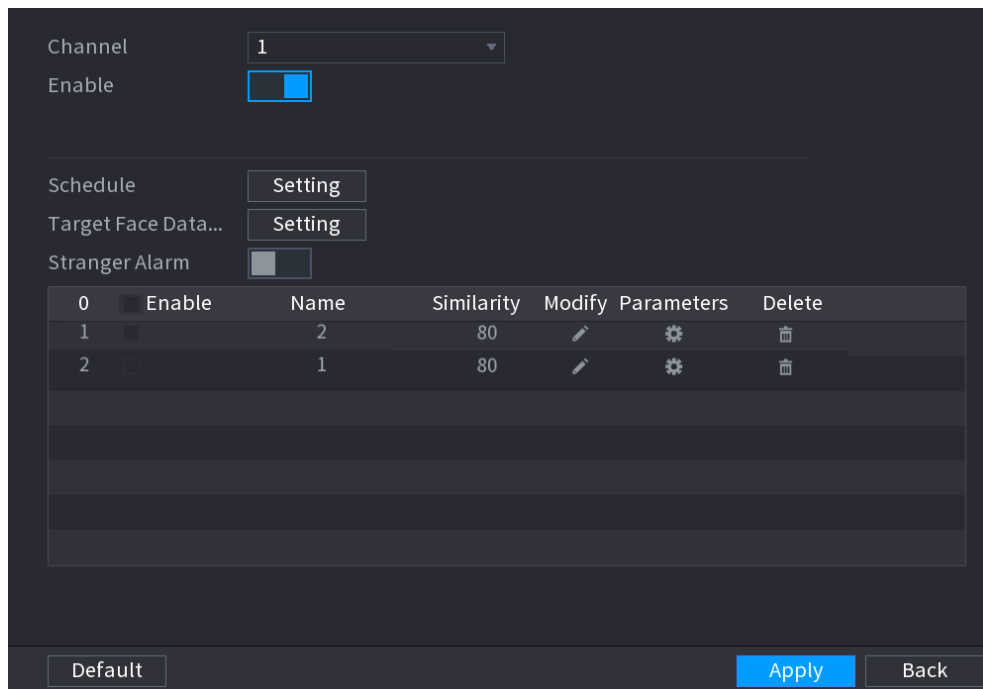

Step 5 Configure the added face database.

- Click to modify the similarity. The lower the number is, the easier the alarm linkage will trigger.
- Click to delete the face database.
- Click to set the alarm linkage.

After setting is completed, click **OK**.

Step 6 (Optional) Enable the **Stranger Mode**.

- 1) Enable the Stranger mode (). When the detected faces do not belong to the face database, the system remarks the face as "Stranger".
- 2) Click **Setting** to set the alarm linkage.
- 3) After setting is completed, click **OK**.

Step 7 Click **Apply** to complete the settings.

After the face recognition function is enabled, right-click on the live view screen, and then select **Live Mode > AI Mode**.

- If the detected face belongs to the enabled face database, the similarity result is displayed.
- If the detected face does not belong to the enabled face database, the face will be remarked as "Stranger".

Figure 5-164 Similarity result

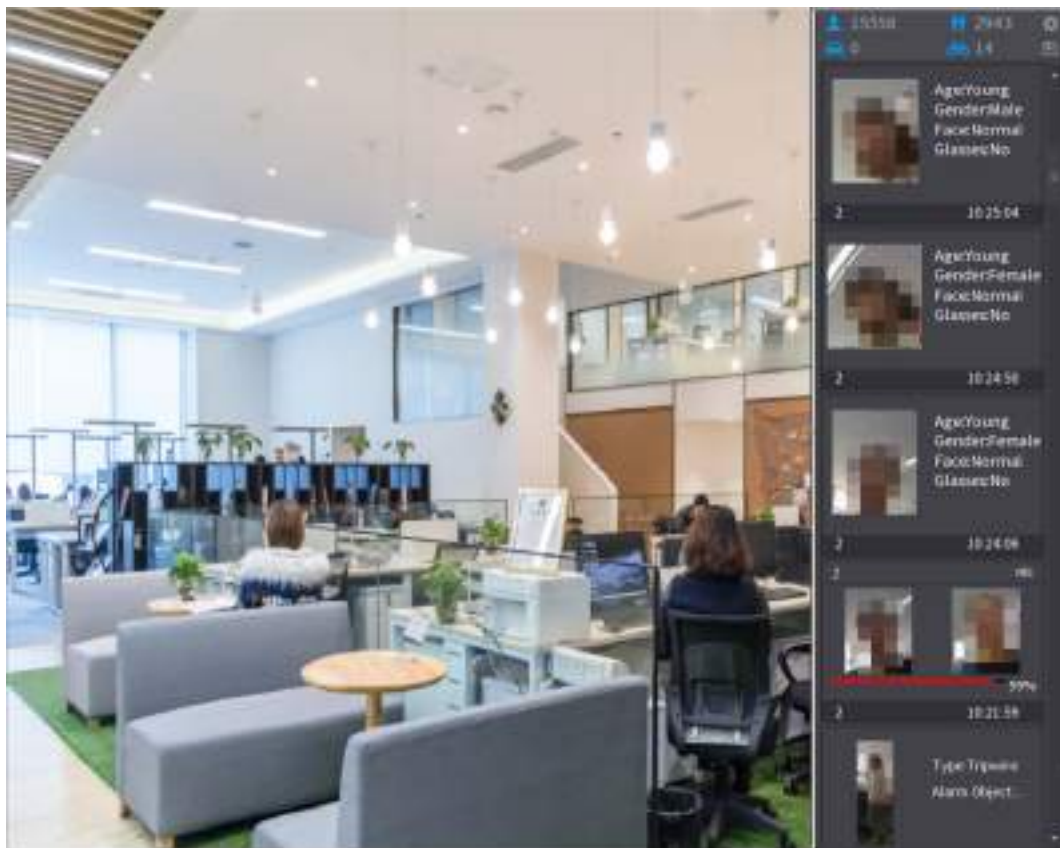

5.11.2.2.3 Smart Search for Face Recognition

You can compare the detected faces with the face database and play back.

- Search by attributes: Search the face database by the face attributes.
- Search by picture: Search the face database by uploading face pictures.

Searching by Attributes

Step 1 Select **Main Menu > AI > AI Search > Face Recognition > Search by Attributes**.

Figure 5-165 Search by attributes

Step 2 Select the channel and set the parameters such as start time, end time, gender, age, glasses, beard, mask, and similarity according to your requirement.

Step 3 Click **Smart Search**.

Figure 5-166 Smart search

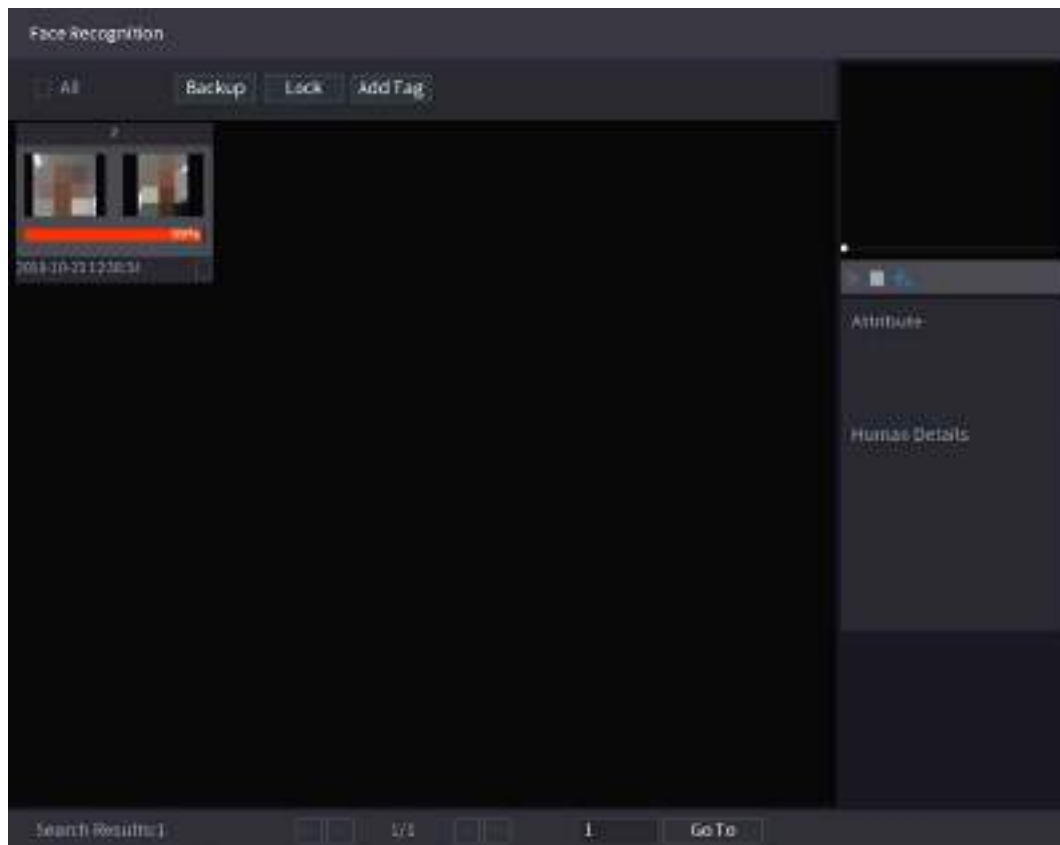

Step 4 Click the picture that you want to play back.

Figure 5-167 Registered information

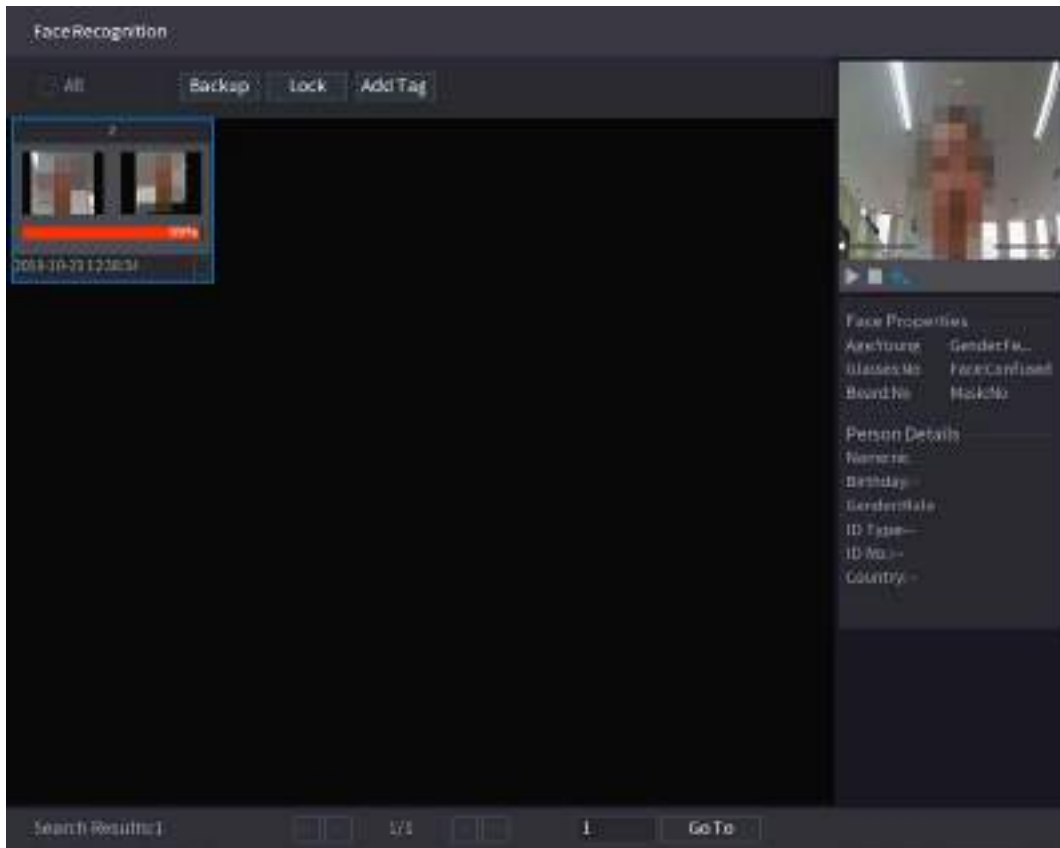

Step 5 Click  to play back the recorded video.



Double-click on the playing page to switch between full screen playing and thumbnail playing.

You can also do the following operations to the recorded files.

- To export the database file (.csv) to the external storage device, select files, click **Export**, and then select the save path.
- To back up the recorded files to the external storage device, select files, click **Backup**, select the save path and file type, and then click **Start**.

Figure 5-168 Backup

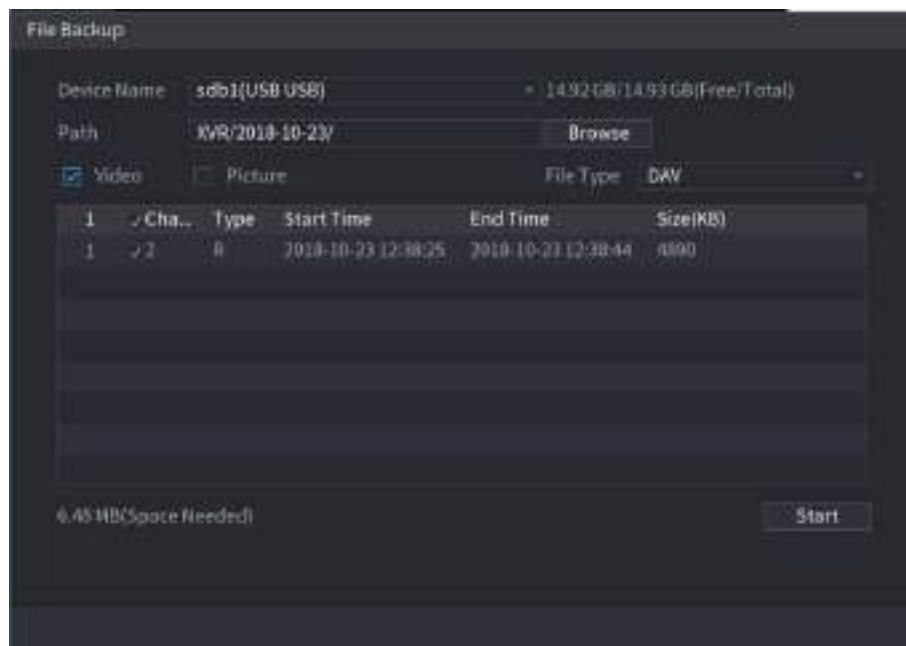

- To lock the files to make it unable to be overwritten, select the files, and then click **Lock**.
- To add a mark to the file, select the files and then click **Add Tag**.

Search by Picture

Step 1 Select **Main Menu > AI > AI Search > Face Recognition > Search by Picture**.

Figure 5-169 Search by picture

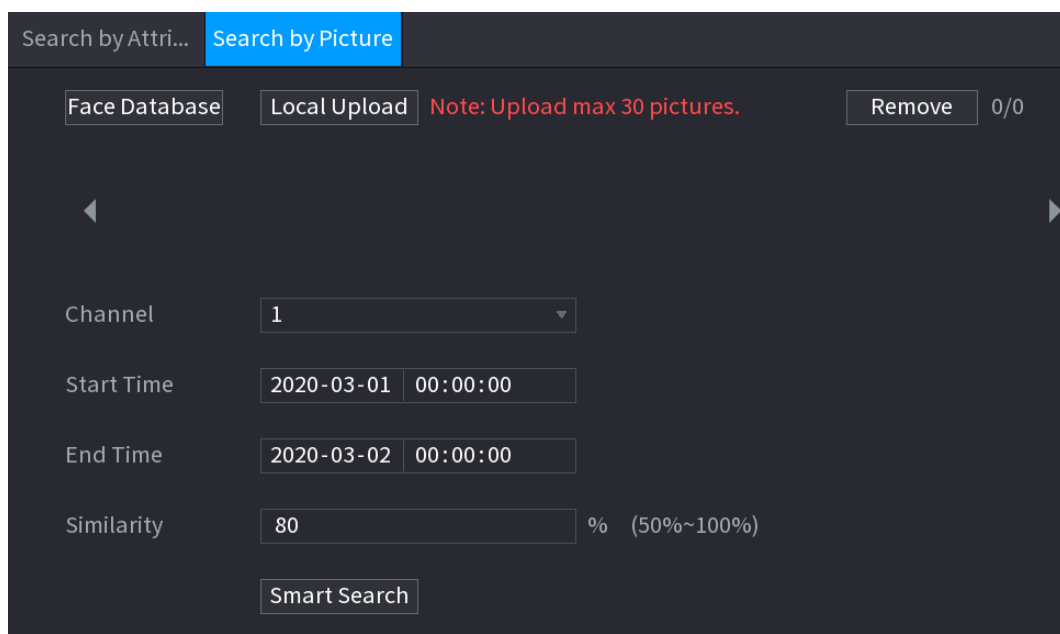

Step 2 Upload face pictures from **Face Database** or **Local Upload**.

NOTE

Maximum 30 pictures can be uploaded at one time, and the system support searching 8 pictures at one time.

- Face Database

- 1) Click Face Database.

Figure 5-170 Face database

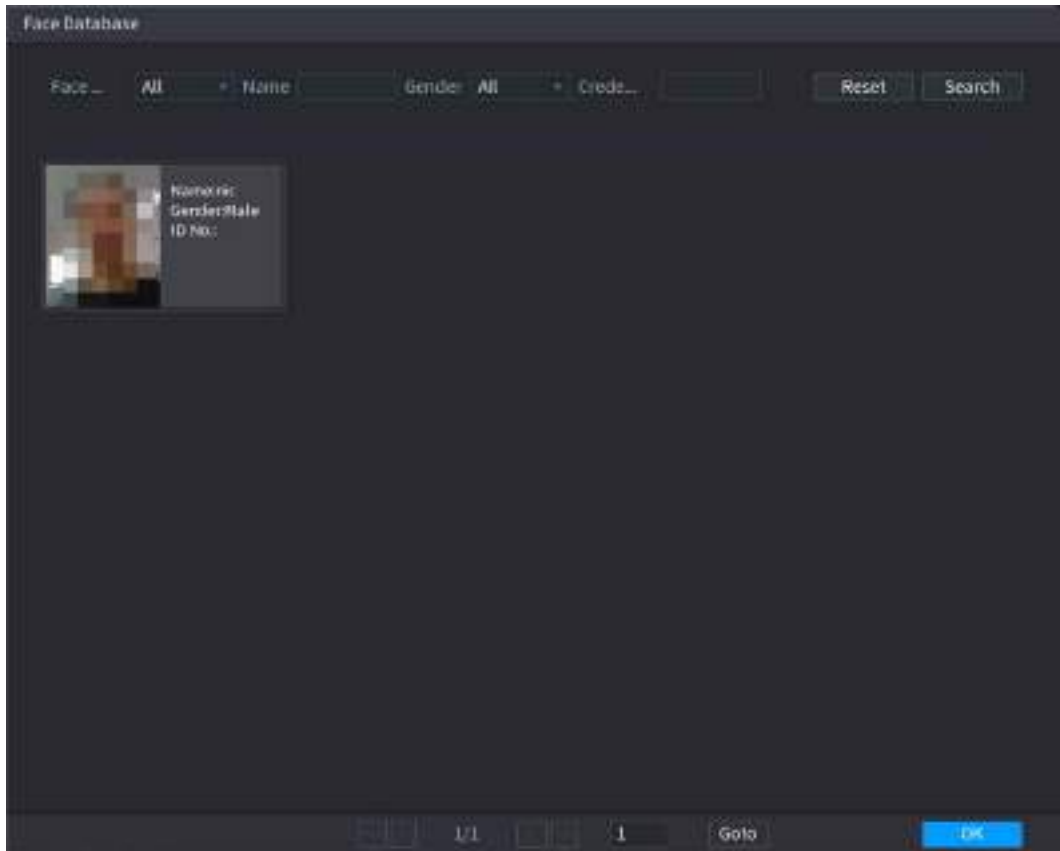

- 2) Set the searching parameters by selecting the face database and gender, and entering name and ID No. according to your actual requirement.
- 3) Click **Search** to display the results that satisfy the requirement.



Click **Reset** to clear the searching parameters.

- 4) Select the picture and then click **OK**.

Figure 5-171 Uploaded picture

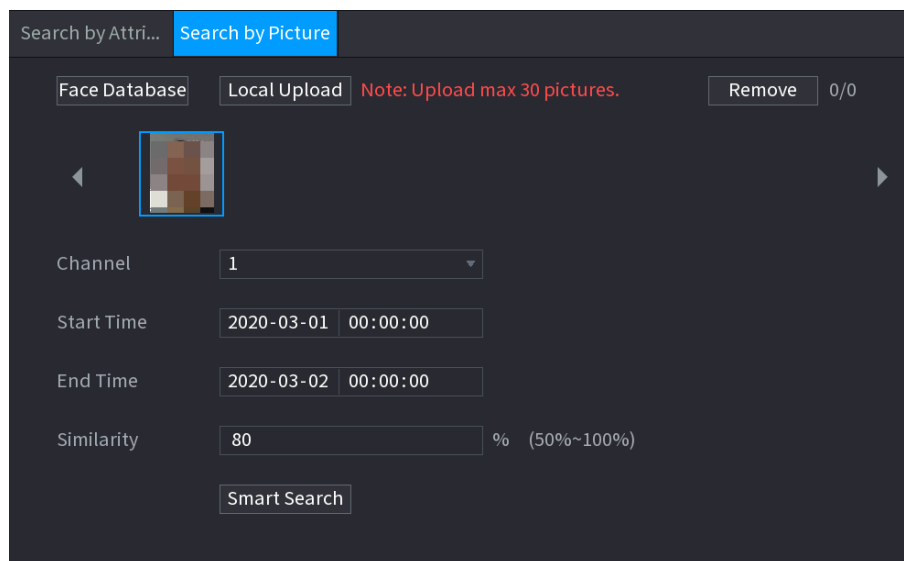

- Local Upload